

# DLX - DLXB pH - RX/MBB



[www.etatronds.com](http://www.etatronds.com)

 **ETATRON D.S.**

**IT** NORME DI INSTALLAZIONE, USO E MANUTENZIONE

**UK** OPERATING INSTRUCTIONS AND MAINTENANCE

DosingPump.ir

**CE**    
UNI EN ISO 9001-2008

**(IT) DIRETTIVA "RAEE" 2002/96/CE E SUCCESSIVA MODIFICA 2003/108/CE SUI RIFIUTI DI APPARECCHIATURE ELETTRICHE ED ELETTRONICHE**

Il simbolo sotto riportato indica che il prodotto non può essere smaltito come normale rifiuto urbano.

Le Apparecchiature Elettriche ed Elettroniche (AEE) possono contenere materiali nocivi per l'ambiente e la salute e pertanto devono essere oggetto di raccolta differenziata: smaltite quindi presso apposite discariche o riconsegnate al distributore a fronte dell'acquisto di una nuova, di tipo equivalente o facente le stesse funzioni.

La normativa sopracitata, alla quale rimandiamo per ulteriori particolari e approfondimenti, prevede sanzioni per lo smaltimento abusivo di detti rifiuti.

**(UK) WASTE OF ELECTRICAL AND ELECTRONIC EQUIPMENT DIRECTIVE (WEEE, RAEE in Italy) 2002/96/EC AND SUBSEQUENT AMENDMENT 2003/108/EC**

*The marking shown below indicates that the product cannot be disposed of as part of normal household waste.*

*Electrical and Electronic Equipment (EEE) can contain materials harmful to health and the environment, and therefore is subject to separate waste collection: it must be disposed of at appropriate waste collection points or returned to the distributor against purchase of new equipment of similar type or having the same functions.*

*The directive mentioned above, to which make reference for further details, provides for punitive actions in case of illegal disposal of such waste.*



<b>INDEX</b>	
<b>1.0 - HINTS AND WARNINGS</b>	<b>26</b>
1.1 - WARNING:	26
1.2 - SHIPPING AND TRANSPORTING THE PUMP	26
1.3 - PROPER USE OF THE PUMP	26
1.4 - RISKS	26
1.5 - TOXIC AND/OR DANGEROUS LIQUID DOSAGE	27
1.6 - ASSEMBLING AND DISMANTLING THE PUMP	27
<b>2.0 - DLX SERIES METERING PUMPS</b>	<b>28</b>
2.1 - OPERATION	28
2.2 - TECHNICAL SPECIFICATIONS	28
2.3 - LIQUID ENDS MATERIALS	29
<b>3.0 - INSTALLATION</b>	<b>30</b>
3.1 - INJECTION VALVE INSTALLATION	31
3.2 - MANUAL STROKE LENGTH ADJUSTMENT	31
<b>4.0 - MAINTENANCE</b>	<b>32</b>
<b>5.0 - HOW TO OPERATE WHEN DOSING SULPHURIC ACID</b>	<b>32</b>
<b>6.0 - MICROCONTROLLED METERING PUMP DLX pH-RX-MBB SERIES</b>	<b>33</b>
6.1 - COMMANDS	33
6.2 - TYPICAL INSTALLATION	33
6.3 - ACCESSORIES	33
6.4 - LEVEL CONTROL	33
6.5 - DISPLAY DESCRIPTION	34
6.6 - PARAMETERS AND FUNCTIONS LAYOUT	35
6.7 - TYPICAL CHARACTERISTICS	35
<b>7.0 - PROGRAMMING</b>	<b>36</b>
7.1 - PUMP SETUP	36
7.2 - MEASURING CALIBRATION	39
7.3 - SETPOINT SETTING	40
7.4 - ALARMS SETTING	42
7.5 - RESET PROCEDURE	43
7.6 - STAND-BY PROCEDURE	43
<b>8.0 - SERVICE CONNECTOR WIRING DIAGRAMS AND FUNCTIONS</b>	<b>44</b>
<b>9.0 - TROUBLE-SHOOTING COMMON TO DLX pH-RX-MBB SERIES PUMPS</b>	<b>45</b>
9.1 - MECHANICAL FAULTS	45
9.2 - ELECTRICAL FAULTS	45
<b>EXPLODED VIEW</b>	<b>49</b>

## 1.0 - HINTS AND WARNINGS

---

Please read the warning notices given in this section very carefully, because they provide important information regarding safety in installation, use and maintenance of the pump.

- Keep this manual in a safe place, so that it will always be available for further consultation.
- The pump complies with EEC directives No.89/336 regarding "electromagnetic compatibility" and No.73/23 regarding "low voltages", as also the subsequent modification No.93/68.

**N.B. The pump has been constructed in accordance with best practice. Both its life and its electrical and mechanical reliability will be enhanced if it is correctly used and subjected to regular maintenance.**

### 1.1 - WARNING:

**Any intervention or repair to the internal parts of the pump must be carried out by qualified and authorized personnel. The manufacturers decline all responsibility for the consequences of failure to respect this rule.**

**GUARANTEE: 1 year (the normal wearing parts are excluded, i.e.: valves, nipples, tube nuts, tubing, filter and injection valve). Improper use of the equipment invalidates the above guarantee. The guarantee is ex-factory or authorized distributors.**

### 1.2 - SHIPPING AND TRANSPORTING THE PUMP

The pump should always be moved in a vertical (and never in a horizontal) position. No matter what the means of transport employed, delivery of the pump, even when free to the purchaser's or the addressee's domicile, is always at the purchaser's risk. Claims for any missing materials must be made within 10 (ten) days of arrival, while claims for defective materials will be considered up to the 30th (thirtieth) day following receipt. Return of pumps or other materials to us or the authorized distributor must be agreed beforehand with the responsible personnel.

### 1.3 - PROPER USE OF THE PUMP

- The pump should be used only for the purpose for which it has been expressly designed, namely the dosing of liquid additives. Any different use is to be considered improper and therefore dangerous. The pump should not therefore be used for applications that were not allowed for in its design. In case of doubt, please contact our offices for further information about the characteristics of the pump and its proper use. The manufacturers cannot be held responsible for damage deriving from improper, erroneous or unreasonable use of the pump.

### 1.4 - RISKS

- After unpacking the pump, make sure it is completely sound. In case of doubt, do not use the pump and contact qualified personnel. The packing materials (especially bags made of plastics, polystyrene, etc.) should be kept out of the reach of children: they constitute potential sources of danger.
- Before you connect the pump, make sure that the voltage ratings, etc., correspond to your particular power supply. You will find these values on the rating plate attached to the pump.
- The electrical installation to which the pump is connected must comply with the standards and good practice rule in force in the country under consideration.
- Use of electrical equipment always implies observance of some basic rules: In particular:
  - 1 - do not touch the equipment with wet or damp hands or feet;
  - 2 - do not operate the pump with bare feet (Example: swimming pool equipment);
  - 3 - do not leave the equipment exposed to the action of the atmospheric agents;
  - 4 - do not allow the pump to be used by children or unskilled individuals without supervision;
- In case of breakdown or improper functioning of the pump, switch off, but do not touch. Contact our technical assistance for any necessary repairs and insist on the use of original spares. Failure to respect this condition could render the pump unsafe for use.
- When you decide to make no further use of an installed pump, make sure to disconnect it from the power supply.

**Before carrying out any service on the item, check:**

1. **Disconnect the pins from the mains or by means of a two poles switch with 3 mm minimum distance between the contacts. (Fig. 4).**
2. **Relieve all the pressure from the pump head and injection tube.**
3. **Drain or flush all dosing liquid from the pump head. This operation can also be done with the pump disconnected from the plant by turning the pump upside-down for 15 to 30 seconds and without connecting the tubing to the nipples: if this operation is not possible, dismantle and remount the pump head using the four mounting screws.**

**In event of possible losses in the hydraulic system of the pump (breakage of the "O" ring gasket, the valves or the hoses) the pump should immediately be brought to a stop, emptying and depressurizing the delivery hose while taking all due safety precautions (gloves, goggles, overalls, etc.).**

## 1.5 - TOXIC AND/OR DANGEROUS LIQUID DOSAGE

To avoid risk from contact with the hazardous liquids or toxic fumes, always adhere to the notes in this instruction manual:

- Follow the instructions of the dosing liquid manufacturer.
- Check the hydraulic part of the pump and use it only if it is in perfect condition.
- Use only the correct materials for the tubing, valves and seals to suit the liquid to be dosed; where possible shield the tubing with PVC conduit.
- Before disconnecting the metering pump, make sure to flush out and neutralize the pump head with the proper reagent liquid.

## 1.6 - ASSEMBLING AND DISMANTLING THE PUMP

### 1.6.1 - ASSEMBLY

All metering pumps are normally supplied fully assembled. For greater clarity, please consult the exploded view of the pump appended at the end of the manual, which shows all the pump details and a complete overview of all the pump components. These drawings are in any case quite indispensable whenever defective parts have to be re-ordered. For the same purpose, the appendix also contains other drawings showing the hydraulic parts (pump head and valves).

### 1.6.2 - DISMANTLEMENT

Proceed as follows before you dismantle the pump or before performing any other operation on it:

1. Disconnect the pins from the mains or by means of a two poles switch with 3 mm minimum distance between the contacts. (Fig. 4).
2. Relieve all the pressure from the pump head and injection tube.
3. Drain or flush all dosing liquid from the pump head. This operation can also be done with the pump disconnected from the plant by turning the pump upside-down for 15 to 30 seconds and without connecting the tubing to the nipples: if this operation is not possible, dismount and remount the pump head using the four mounting screws. (Fig. 10).

This operation calls for special attention, and you should therefore consult the drawings in Appendix and Chapter 1.4 "RISKS" before you commence work.

## OVERALL DIMENSIONS (Fig. 1)

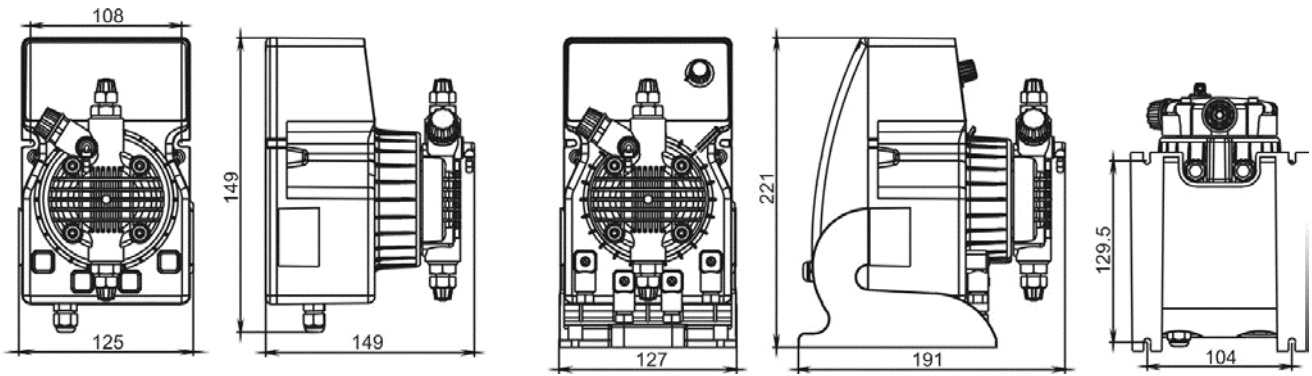

## 2.0 - DLX SERIES METERING PUMPS

### 2.1 - OPERATION

The metering pump is activated by a teflon diaphragm mounted on a piston of an electromagnet.

When the piston of the electromagnet is attracted, a pressure is produced in the pump body with an expulsion of liquid from the discharge valve. Once the electric impulse is finished a spring brings the piston back to the initial position, with a recall of liquid through the suction valve.

The operation is simple the pump does not need lubrication, therefore maintenance is reduced almost to zero.

The materials used for the construction of the pump make it particularly suitable for aggressive liquids.

The metering pump has been designed to feed liquids with capacities from 0 to 20 l/h and pressures from 0 to 15 bar (depending on the model selected).

### 2.2 - TECHNICAL SPECIFICATIONS

- The products are manufactured according  regulation.
- Antiacid plastic casing.
- Control panel protection assured by an adhesive polyester film, weatherproof and resisting UV ray
- Standard power supply (fluctuations not to exceed  $\pm 10\%$ ):  
230 V a.c. 50 Hz single phase.
- Optional power supply (fluctuations not to exceed  $\pm 10\%$ ):  
240 V a.c. 50-60 Hz single phase;  
110 V a.c. 50-60 Hz single phase.
- Overvoltage cat. II.
- Environmental Conditions: IP65 protection, indoor use statement, altitude up to 2000m, ambient temperature 5C to 40C, maximum relative humidity 80% for temperatures up to 31°C decreasing linearly to 50% relative humidity at 40°C.
- Pollution degree 2
- Upon request: manual stroke length adjustment. This control provides accurate flow adjustment. (only DLXB series)

### 2.3 - LIQUID ENDS MATERIALS

DIAPHRAGM: PTFE

PUMP HEAD: Polypropylene; upon request: PVC, 316 Stainless, PTFE, PVDF

NIPPLES: polypropylene

FILTER: polypropylene

INJECTION NIPPLE: polypropylene

SUCTION HOSE: PVC - flexible

DISCHARGE HOSE: polyethylene

VALVES "lip" type: FPM (viton), (upon request available in EPDM (Dutral), NBR, Silycon). "Ball Check" VALVES upon request type in SS 316 and Glass PYREX. Available with Spring Return and "KALREZ" Valve.

SEALS: FPM upon request EPDM (Dutral), NBR, Silycon, PTFE only for ball checks valves

## TECHNICAL CHARACTERISTICS

Tipo Type	Portata max Max flow l/h	Pressione max Max press bar	Max imp./min. Max imp./min.	Dosaggio per imp. Output per stroke ml	Corsa Stroke mm	Altez. aspiraz. Suction height m	Aliment. elettr. standard Standard power supply Volts - Hz	Potenza ass. Power comp. Watts	Corrente ass. Current comp. Ampere	Peso netto Net weight kg
1-15	1	15	120	0.14	0.80	2.0	230 V 50-60 Hz	37	0.16	2.3
2-10	2	10	120	0.28	0.80	2.0	230 V 50-60 Hz	37	0.16	2.3
5-7	5	7	120	0.69	1.00	2.0	230 V 50-60 Hz	37	0.16	2.3
5-12	5	12	120	0.69	1.00	2.0	230 V 50-60 Hz	58	0.25	2.9
8-10	8	10	120	1.11	1.40	2.0	230 V 50-60 Hz	58	0.25	2.9
15-4	15	4	120	2.08	2.20	2.0	230 V 50-60 Hz	58	0.25	2.9
20-3	20	3	120	2.60	2.20	2.0	230 V 50-60 Hz	58	0.25	2.9
2-20	2	20	120	0.28	1.00	2.0	230 V 50-60 Hz	58	0.25	2.9

ENGLISH

Fig. 2

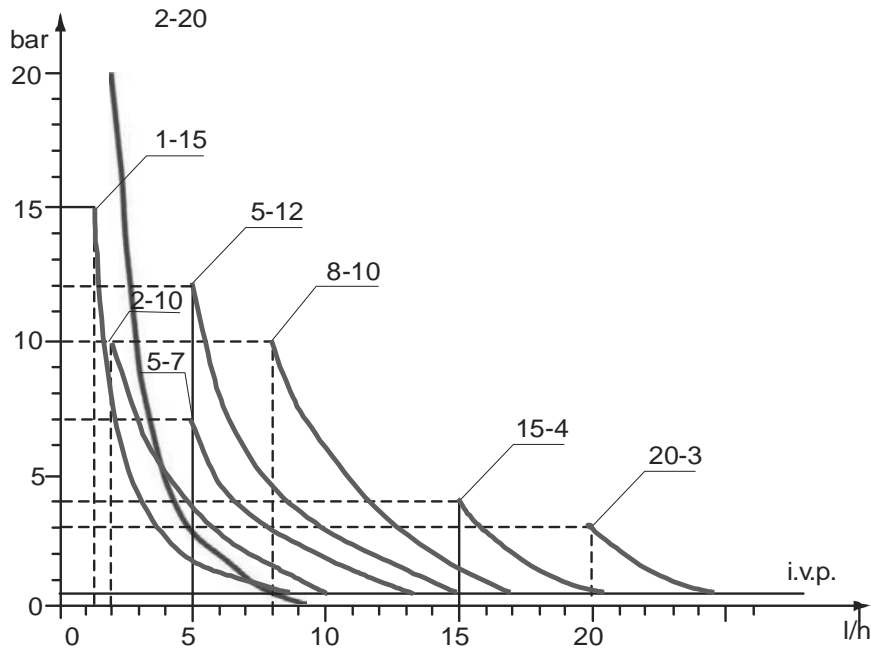

Fig. 3

The diagrams of fig. 3 indicate max metering pump flow variation in relation to the working pressure in the plant; the diagrams also include injection valve losses. I.V.P.

Due to production requirements the technical characteristics of our equipment at maximum ratings can vary with a tolerance of 5% which must be taken into account when choosing the type of pump.

DosingPump.ir

### 3.0 - INSTALLATION

- a. - Install the pump in a dry place and well away from sources of heat and, in any case, at environmental temperatures not exceeding 40°C. The minimum operating temperature depends on the liquid to be pumped, bearing in mind that it must always remain in a liquid state.
- b. - Carefully observe the regulations in force in the various countries as regards electrical installations (Fig.4). **When the supply cable is devoid of a plug, the equipment should be connected to the supply mains by means of a single-pole circuit breaker having a minimum distance of 3 mm between the contacts. Before accessing any of the electrical parts, make sure that all the supply circuits are open.**

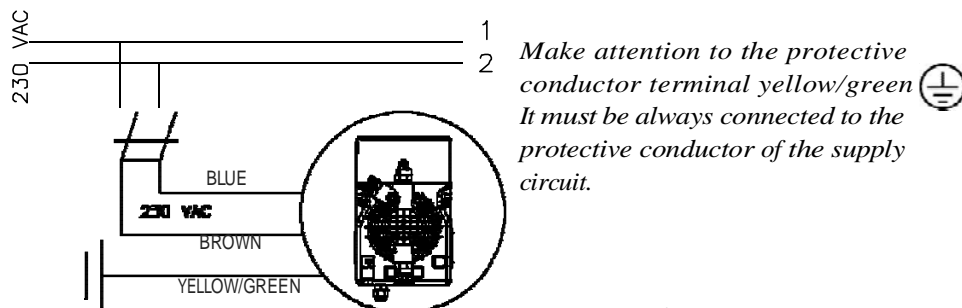

Fig. 4

- c.- Locate the pump as shown in fig. 5 bearing in mind that it may be installed either below or above the level of the liquid to be dosed, though the level difference should not exceed 2 meters. When the process plant in which the pump is installed is operating at atmospheric pressure (no back pressure) and the chemical tank is situated above the plant (Fig. 6), the condition of the injection valve should be checked at regular intervals, because excessive wear and tear could cause additive to drip into the plant even when the pump is shut down. If the problem persists, install a properly calibrate counter-pressure valve (C) between injection point and the valve. In the case of liquids that generate aggressive vapours, do not install the pump above the storage tank unless the latter is hermetically sealed.

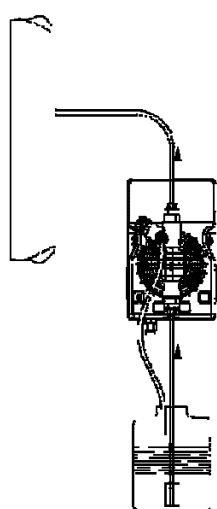

Fig. 5

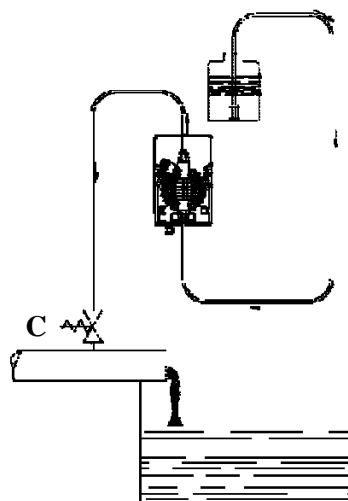

Fig. 6

- d.- The discharge nipple will always remain in the upper part of the pump. The suction nipple, which serves to attach the hose (with filter) leading into the chemical tank, will therefore always be situated in the lower part of the pump.

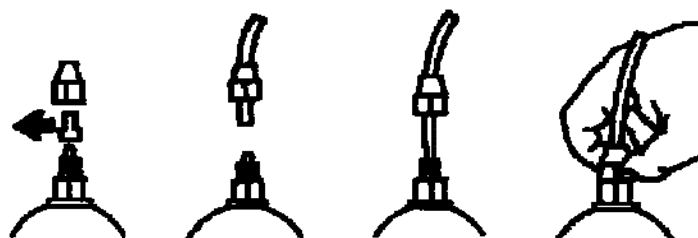

Fig. 7

- e.- Remove the protection caps from the two nipples, slide the hoses over the connectors, pushing them right home, and then fix them with appropriate tube nuts. (Fig. 7).



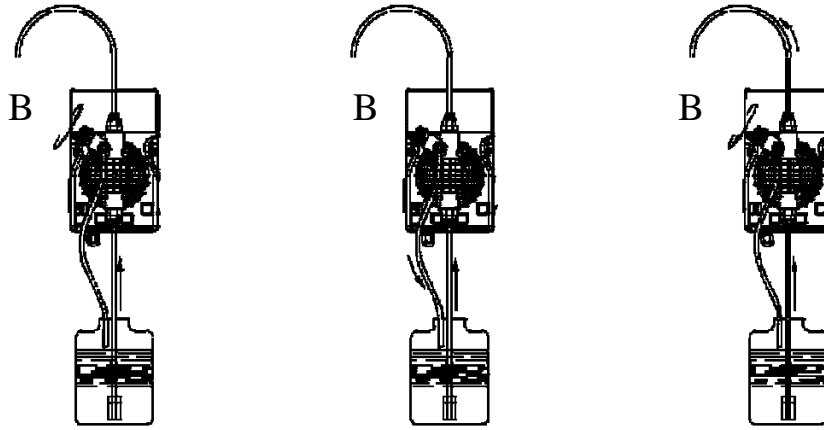

Fig. 8

Whenever the pump is dismantled from the pipework, you will be well advised to replace the caps on the connectors to avoid residual liquid being spilled. Before attaching the delivery hose to the plant, prime the metering pump by going through the sequence shown in Fig. 8. Before finalizing the installation of the discharge hose, make sure that the pump strokes will not cause it to move and bump into rigid bodies. In case of priming difficulties, use a normal syringe to suck liquid from the discharge nipple while the pump is in operation, continuing until you actually see the liquid rise in the syringe. Use a short length of suction hose to connect the syringe to the discharge nipple. In case of a pump equipped with an air bleed valve, unscrew the air relief valve B up to all the air in the pump head will be out.

- f. - Try to keep both the suction and discharge hose as straight as possible, avoiding all unnecessary bends.
  - g. - Select the most appropriate injection point on a pipe of the plant to be treated and there fit a 3/8" female steel gas thread connector (similar to BSPm). This connector is not supplied with the pump. Screw the injection valve to the gas connector, inserting a gasket as shown in Fig. 9. Then connect the discharge hose to the conical connector on the injection valve and fix it with the supplied tube nut G. The injection valve also acts as no return valve by means of a cylinder sleeve (elastomer, standard supplied in Viton).
- N.B. The sleeve D must not be removed.**

### 3.1 - INJECTION VALVE INSTALLATION

DIAGRAM (Fig. 9)

- A - Pipework
- C - Injection valve
- M - Conical connector for attaching the discharge hose
- N - 3/8" female steel gas thread connector
- G - Hose tube nut
- T - Polyethylene hose
- D - Cylinder sleeve (no return valve)

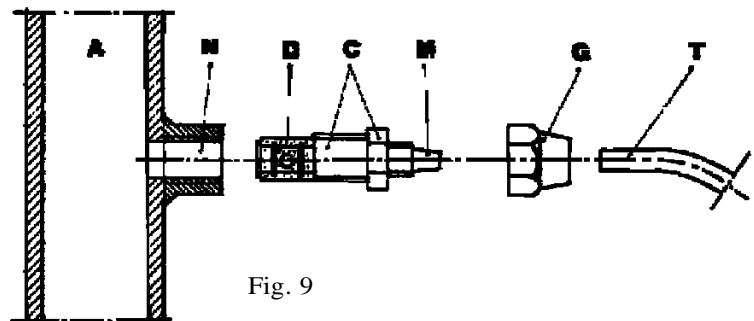

Fig. 9

### 3.2 - MANUAL STROKE LENGTH ADJUSTMENT - (upon request only for DLXB)

- press and turn the knob up to the stroke length adjustement required.



## 4.0 - MAINTENANCE

---

1. Periodically check the chemical tank level to avoid the pump operating without liquid. This would not damage the pump, but may damage the process plant due to lack of chemicals.
2. Check the pump operating condition at least every 6 months, pump head position, screws, bolts and seals; check more frequently where aggressive chemicals are pumped, especially:
  - pulse and power L.E.D.;
  - the additive concentration in the pipework; a reduction of this concentration could be caused by the wearing of the valves, in which case they need to be replaced (Fig. 10) or by the clogging of the filter which then has to be cleaned as in point 3 here below.

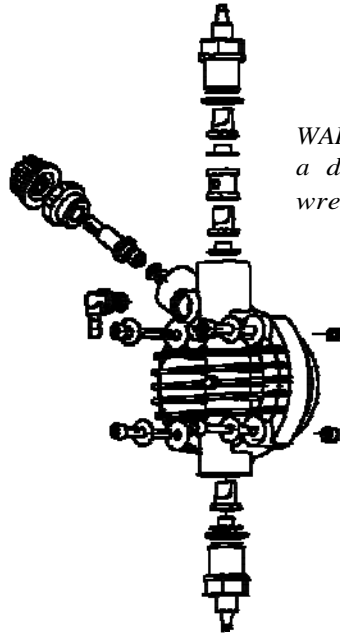

**WARNING:** to tightening the four screws, use a dynamometric screw driver, set the torque wrench to 1,8N x m.

Fig. 10

3. The Company suggests periodically cleaning off the hydraulic parts (valves and filter). We cannot say how often this cleaning should be done as it depends on the type of application, we also cannot suggest what cleaning agent to use as this will depend on the additive used.

Operating suggestions when dosing sodium hypochlorite (most frequent case):

- a - disconnect the pins from the mains or by means of a onnipolar switch with 3 mm minimum distance between the contact.
- b - disconnect discharge hose from pipework;
- c - remove the suction hose (with filter) from the tank and dip it into clean water;
- d - switch on the metering pump and let it operate with water for 5 to 10 minutes;
- e - switch OFF the pump, dip the filter into a hydrochloric acid solution and wait until the acid finishes cleaning;
- f - switch ON the pump again and operate it with hydrochloric acid for 5 minutes in a closed-circuit, with suction and discharge hose dipped into the same tank;
- g - repeat the operation with water;
- h - re-connect the metering pump to the pipework.

## 5.0 - HOW TO OPERATE WHEN DOSING SULPHURIC ACID (MAX 50%)

---

In this case it is essential to bear in mind the following:

1. replace PVC crystal suction hose with polyethylene discharge hose;
2. empty any residual water from the pump head beforehand.

**Warning: if the water mixes with sulphuric acid it can produce a large quantity of gas with consequent overheating of the area causing damage to valves and pump head.**

This operation can also be done with the pump disconnected from the plant by turning the pump upside-down for 15 to 30 seconds and without connecting the hose to the nipples; if impossible, dismount and remount the pump head (Fig. 10) using the four mounting screws.

DosingPump.ir

# DLX pH-RX/MBB



## 6.0 - MICROCONTROLLED METERING PUMP DLX pH-RX-MBB SERIES

### 6.1 - COMMANDS (Fig.11)

- 1 - Confirm button "OK"
- 2 - Increase value button "+"
- 4 - Decrease value button "-"
- 5 - Alarm LED "yellow"
- 6 - Pulse LED "red"
- 7 - Power on LED "green"
- 8 - LCD display

### 6.2 - TYPICAL INSTALLATION (Fig.12)

- A Injection valve
- B Power supply
- C Filter
- H Cable gland
- I Chemical tank
- V Process tank

### 6.3 - ACCESSORIES

- 1 flexible PVC suction hose, transparent crystal type, length 2 m;
- 1 semirigid polyethylene hose, white, length 2 m;
- 1 injection valve 3/8 BSP m;
- 1 filter;
- 1 instructions/operating booklet.

### 6.4 - LEVEL CONTROL

DLX Control is supplied with level control setting. When the chemical tank is empty, on the display will appear LEVEL and the pump goes in stand by. The level control has 5 seconds of delay.

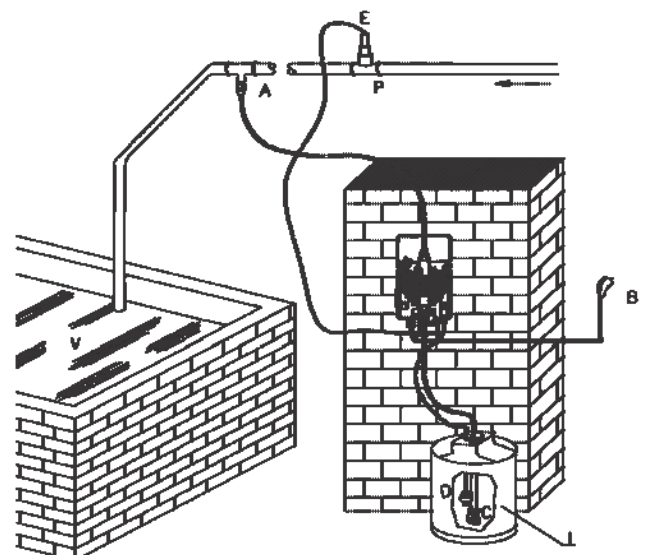
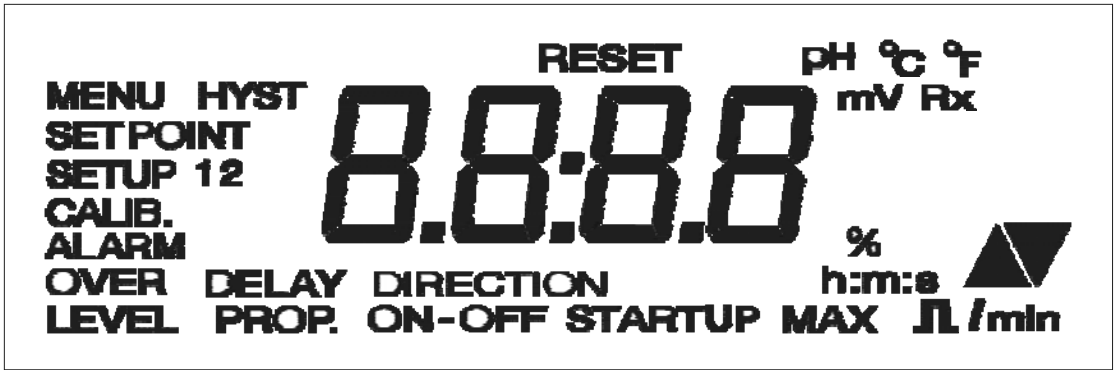
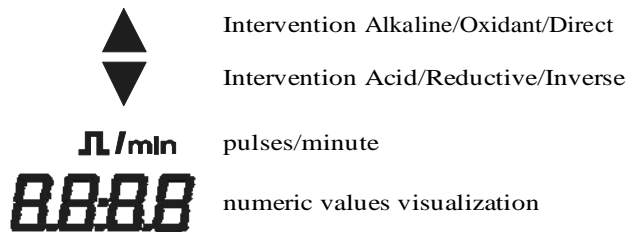

Fig. 12

6.5 - DISPLAY DESCRIPTION



<b>OVER</b>	Overdosing alarm
<b>DELAY</b>	Delay at powering on
<b>SETPOINT</b>	Setpoint setting
<b>LEVEL</b>	Level alarm
<b>ALARM</b>	Alarms setting
<b>MENU</b>	Menu selection
<b>ON-OFF</b>	ON-OFF functioning mode
<b>PROP.</b>	Proportional functioning mode
<b>HYST</b>	Hysteresis setting
<b>12</b>	Calibration points
<b>CALIB.</b>	Calibration menu
<b>SETUP</b>	General instrument settings
<b>STARTUP</b>	Switching-on delay settings
<b>RESET</b>	Reset activation
<b>DIRECTION</b>	Intervention selection
<b>MAX</b>	Maximum pulses frequency based to maximum measuring value
<b>h:m:s</b>	Hours:minutes:seconds
<b>°C</b>	Temperature measurement unit in Celsius
<b>°F</b>	Temperature measurement unit in Fahrenheit
<b>%</b>	Flow rate percentage
<b>mV Rbx</b>	mV measure
<b>pH</b>	pH measure



## 6.6 - PARAMETERS AND FUNCTIONS LAYOUT (Factory default - pH)

<b>FUNCTIONS</b>	<b>DEFAULT</b>
<i>Setpoint setting</i>	<b>7,2</b>
<i>Hysteresis setting</i>	<b>0,1</b>
<i>Choice of the type of intervention</i>	<b>Acid</b>
<i>Manual or proportional intervention selection</i>	<b>Manual</b>
<i>Definition of beginning intervention value "AUTO"</i>	<b>Setpoint + 1pH</b>
<i>First point of calibration procedure</i>	<b>-----</b>
<i>Second point of calibration procedure</i>	<b>-----</b>
<i>Minimum alarm point</i>	<b>0,00</b>
<i>Maximum alarm point</i>	<b>14,00</b>
<i>Over-dosing alarm value</i>	<b>99:59 h:m</b>
<i>Selection measures to control (pH, RX)</i>	<b>pH</b>
<i>Chosen thermal selection (°C or °F)</i>	<b>°C</b>
<i>Temperature compensation selection (manual - auto)</i>	<b>Manual - 25°C</b>
<i>Delay at powering on</i>	<b>00:03 m:s</b>
<i>Delay exit calibration menu</i>	<b>05:00 m:s</b>

## 6.7 - TYPICAL CHARACTERISTICS

<b>PARAMETER</b>	<b>VALUE</b>
<i>Temperature</i>	<b>0÷40°C</b>
<i>Max current relay output</i>	<b>6A (resistive load) 1A (inductive load)</b>
<i>pH measure</i>	<b>0÷14 (0,01 pH)</b>
<i>RX (mV) measure</i>	<b>-1000 ÷ +1400 (±1 mV)</b>

## 7.0 - PROGRAMMING

Through the front panel it is possible to set and to modify all the working parameters of operating setting of the pump.

### 7.1 - PUMP SETUP

The first operation to do is to select the type of parameter (pH, Redox) that is intends to measure and to control.

The pump has turned on, on display it appear software revision then SETUP menu and the type of controlled parameter that it flashes (default settings: pH).

In this phase it is possible to set measure type by means on the + and - buttons and to confirm through the **OK** button.

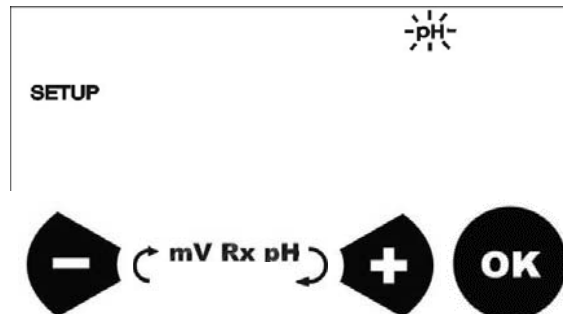

After confirm with the **OK** button the measure's type, the pump goes in measure mode, on display will show the measure's value



Press **OK** button to enter in menus; the first is SETPOINT menu, using + and - buttons you will scroll all 3 menus.



*Setpoint menu*

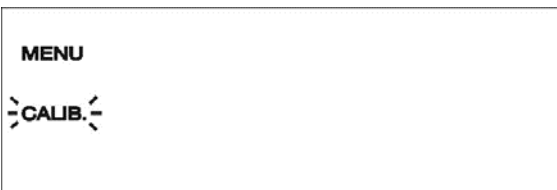
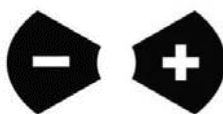

*Calibration menu*

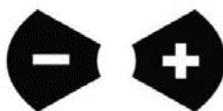

*Alarm menu*

To enter in **SETUP** menu scroll all menus with + and - buttons up to reach the desired menu (on display will show **SETUP**), press **OK** to confirm.

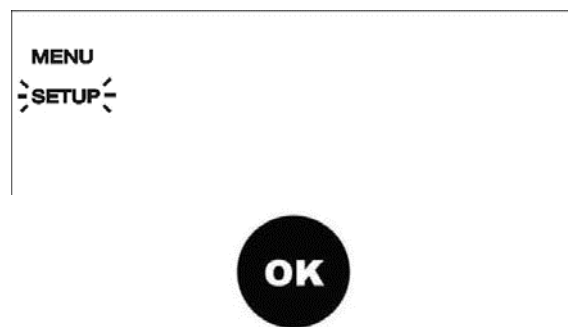

### 7.1.1 - Measure type selection

Once pressed **OK** the pump goes in **SETUP** mode. In this mode is possible to select the type of control (measure) that it want to effect. This mode is a loop among pH, Redox; as default pH will flash. Acting on + and - buttons, user can select among 2 possibilities, (pH, RX mV). Pressing the button **OK** is confirmed the selected choice.

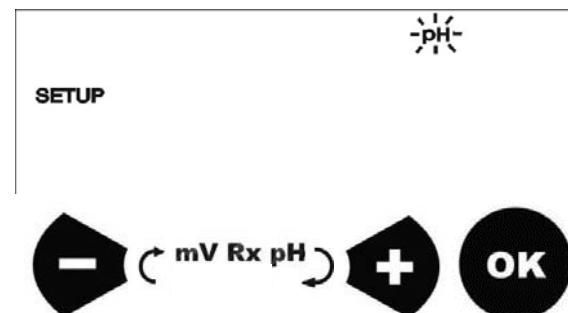

### 7.1.2 - Temperature selection between Celsius and Fahrenheit degrees

Continuing in the **SETUP** menu, pressing **OK**, it is possible to select temperature reading reading between Celsius and Fahrenheit degrees ( $^{\circ}\text{C}$  or  $^{\circ}\text{F}$ ).

To shift use + or - buttons.

Pressing **OK** to confirm and to save the choice.

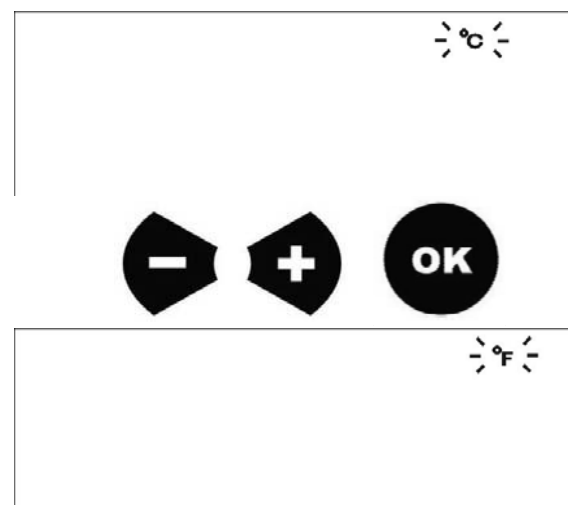

### 7.1.3 - Temperature compensation

Once in the temperature compensation, on the display will flash the default temperature value i.e.  $25^{\circ}\text{C}$ . Using + and - buttons it is possible to change this value. When the desired value is reached press **OK** again and the values will be memorized.



DosingPump.ir

### 7.1.4 - Switching-on delay

To solve the problem of inertia of some electrodes or plant installation, the pump has the possibility to set a delay time from pump switching-on to the measuring and control moment.

Using + and - it's possible to set the delay time, from 0 to 99 min.  
(0÷1min=step by 1second; 1÷5min=step by 15seconds; 5÷99min=step by 1minute).

Press **OK** to confirm.





## 7.2 - MEASURING CALIBRATION

To calibrate the pump integrated controller, user has to adjust two calibration points for any kind of parameter, i.e. pH, Redox.

To enter in CALIB. menu, from measuring mode, press **OK** button then the + button, on display CALIB. will flash, press **OK** button again to confirm.

On display will appear POINT 1

### pH PROCEDURE:

- Dip the electrode in buffer solution 7.00.
- Adjust the value on the display up to reach 7.00 with + and - buttons.
- Press **OK** to save the data. On display will appear POINT 2.
- Dip the electrode after washing with tap water in the second buffer solution; we suggest 4.00 or 9.00 pH.
- Adjust the value on the display up to reach the second buffer solution value with + and - buttons.
- Press **OK** to save the data.

### REDOX (mV) PROCEDURE:

- Put in short circuit the BNC connector. Using a metal wire, connect the core pin with the external cylinder part.
- Adjust the value on the display up to reach 0 using + and - buttons.
- Press **OK** to save the data.
- On the display will appear POINT 2
- Dip the electrode in a buffer solution. We suggest 250, 475 or 650mV.
- Adjust the value on the display up to reach the buffer solution value using + and - buttons.
- Press **OK** to save the data.

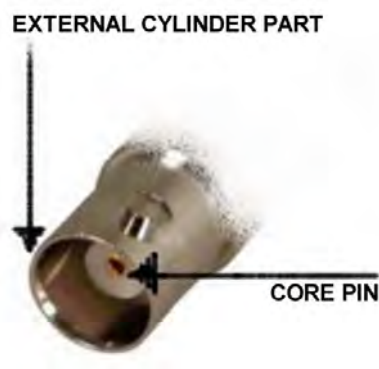
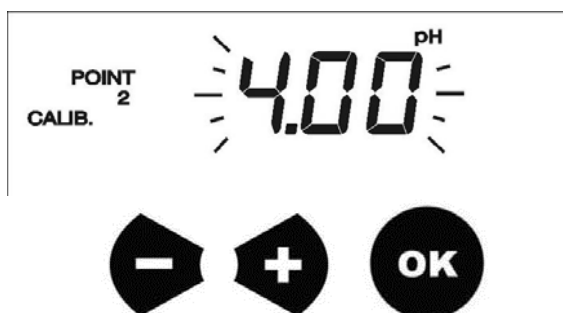
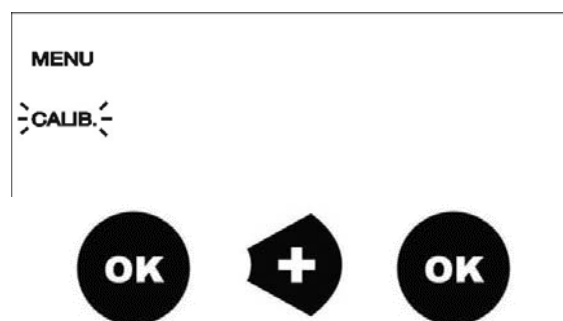

### 7.3 - SETPOINT SETTING

To have the pump operative it's mandatory set the following data: Setpoint values, type of dosing, hysteresis, manual or proportional dosing.

#### 7.3.1 - Setpoint value

From measuring status, pressing **OK**, the pump will go in SETPOINT programming phase. Setpoint icon will flash. Pressing **OK** again, the setpoint value saved will flash and can be adjusted using + and - buttons.

Pressing **OK**, the setpoint value will be memorized.

The pump automatically will go in DIRECTION menu



#### 7.3.2 - Direction menu

In this menu, has to set if the pump has to dose above the setpoint or below this value. For instance to reduce pH value, dosing an acid chemical, the direction arrow has to point down. In this way the pump will be active, dosing, when the pH value is higher than the setpoint previously set.

For Redox if the pump has to dose up to reach a certain quantity of oxidant, the direction arrow has to point in aloft.

To select the direction of the arrow, use the + and - buttons.

Pressing **OK** the direction will be memorized.

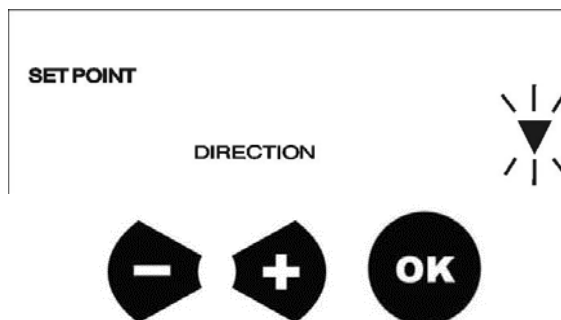

#### 7.3.3 - Manual or Proportional mode

After selected direction of the dosing, the pump will show ON-OFF or PROP. flashing. With + or - buttons it's possible to shift among them.

ON-OFF - When the pump has to dose it will run at flow rate selected by the user in Flow rate setting, and it stops at the Setpoint.

PROP. - In this mode the pump will dose proportionally to the setpoint value. The pump starts dosing over setpoint (determined by hysteresis), increasing its speed up to the MAX FREQUENCY ADJUSTMENT use will set after pressing **OK** from this menu.

Use + and - to select the operative mode.

Press **OK** to confirm the selection. Following will be described these two modes:

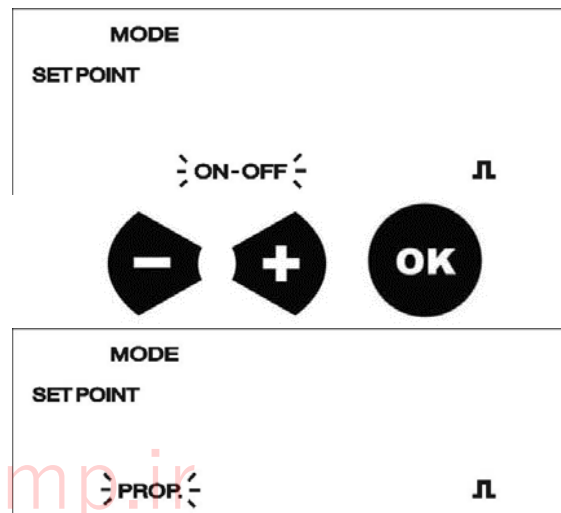

DosingPump.ir

### 7.3.4 - Hysteresis menu

After selected direction of dosing, user has to adjust the hysteresis value: distance from the setpoint value, over this value the pump starts or stops its dosing.

After pressing the **OK** button the instrument goes to Hysteresis menu setting.

Press **+** and **-** to set the desired hysteresis value.  
Press **OK** button to confirm and to save value.

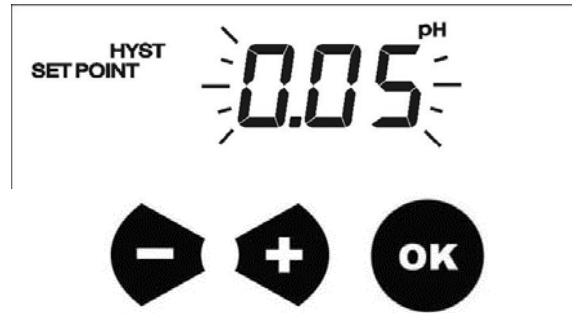

### 7.3.5 - Frequency adjustment

If the user has select Manual mode (**ON-OFF**), after pressing **OK** button, the pump will pass in Frequency adjustment menu. User has to set the flow rate of the pump, from 0 to 100% of maximum frequency.

Use **+** and **-** buttons to select the desired flow rate percentage.  
Pressing **OK** the pump will save data and go out from Setpoint mode. It will be enough to press **ESC** button to go in metering mode.

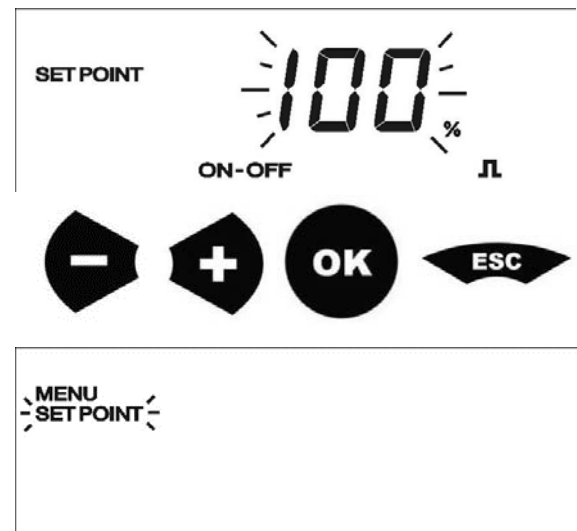

### 7.3.6 - Max frequency adjustment

If the user has select Proportional mode (**PROP.**), after pressing **OK** button, the pump will pass in Max Setpoint value based to de Maximum frequency. User has to set at which pH, Redox value the pump has to dose at the maximum speed. The pump self controls its flow rate from this point, up to the setpoint where it stops dosing.

Use **+** and **-** buttons to select the maximum measure value to which the pump has to dose at the maximum frequency.  
Pressing **OK** the pump will save data and go out from Setpoint mode. It will be enough to press **ESC** button to go in metering mode.



## 7.4 - ALARMS SETTING

It is possible to plan three different types of alarm pump:

- 1 - **MAX**: User can set at which maximum value the pump has to go in alarm mode. When the pump will go over this value, on the display, Alarm message will flash, Alarm Led will flash.
- 2 - **min**: User can set at which minimum value the pump has to go in alarm mode. When the pump will go over this value, on the display, Alarm message will flash, Alarm Led will flash.
- 3 - **OVER**: Overdosing alarm. For any kind of problems may occur in the plant (wrong calibration, dirty or broken probe, etc.) if the pump doesn't reach the Setpoint in OVERALARM TIME, the pump stops the dosing. On the display Alarm message will flash, Alarm Led will flash.

To enter in ALARM menu follow the procedure described in paragraph 7.1 - PUMP SETUP.

When ALARM menu is reached, press **OK** to enter in submenus

### 7.4.1 - Maximum Alarm setting

On the display will appear MAX and the value of measure will flash.

Press + and - to adjust the maximum value of the measure

Press **OK** to confirm and to save data.

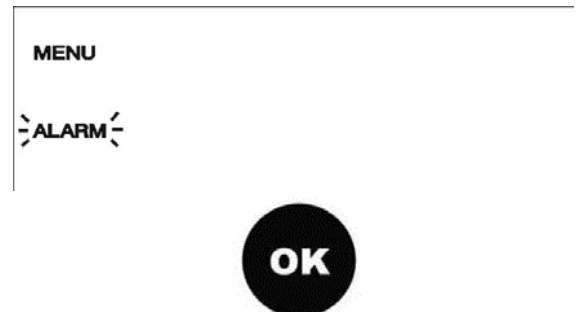

### 7.4.2 - Minimum Alarm setting

On the display will appear "min" and the value of measure will flash.

Press + and - to adjust the minimum value of the measure

Press **OK** to confirm and to save data.



### 7.4.3 - Overdosing Alarm setting

On the display will appear OVER and time counter (h:min) will flash.

Press + and - to adjust the time, over which the pump will go in alarm.

Press **OK** to confirm and to save data.

This will end the alarm setting.

Press **ESC** to return in measure mode.



DosingPump.ir

### 7.5 - RESET PROCEDURE

Following is described the RESET procedure:

- Turn off and turn on the pump
- Press at the same time ESC and OK buttons until will appear the revision firmware (ex. 02.3.3) it will appear SETUP menu and the default parameter start flashing

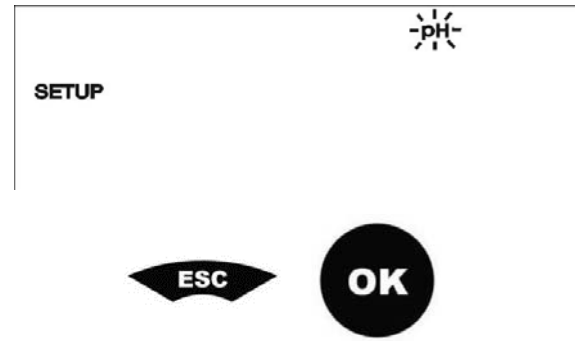

### 7.6 - STAND-BY PROCEDURE

With this procedure the pump is put on stand-by.

- Hold down key + and - until Stand-by appears on the display
- In order to exit this mode, hold down keys + and -.



## **8.0 - SERVICE CONNECTOR WIRING DIAGRAMS AND FUNCTIONS**

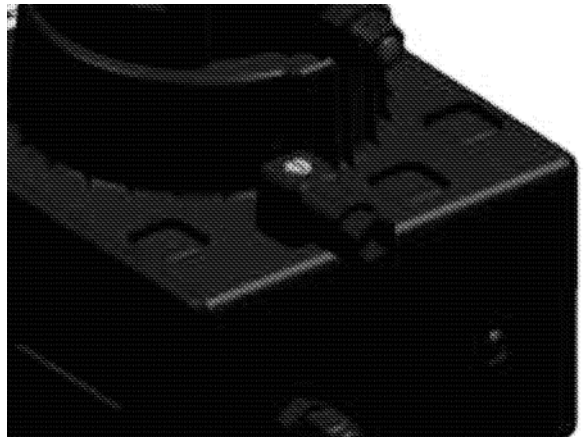

*Service connector wire assembly*

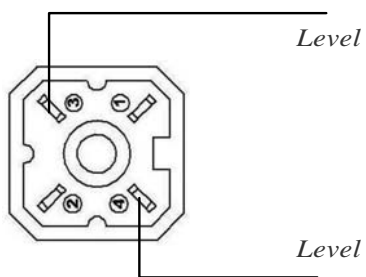

*Functions and technical informations*

*Connection to the **Level probe***

*Configuration:*

*Pin 1 = No connection*

*Pin 2 = No connection*

*Pin 3 = level probe wire*

*Pin 4 = level probe wire*

## **9.0 - TROUBLE-SHOOTING COMMON TO DLX pH-RX/MBB SERIES PUMPS**

### **9.1 - MECHANICAL FAULTS**

*As the system is quite robust there are no apparent mechanical problems. Occasionally there might be a loss of liquid from the nipple because the tube nut has loosened, or more simply the discharge tubing-has broken. Very rarely there may be losses caused by the breakage of the membrane, or by the membrane seals in which case they have to be replaced by disassembling the four screws of the pump head (fig. 10), when re-mounting the pump head ensure that the screws are replaced properly, along with "O" ring. After repair, the metering pump will need to be cleaned of additive residues which can damage the pump casing.*

#### **● 1 ● THE METERING PUMP GIVES PULSES BUT THE ADDITIVE IS NOT INJECTED**

- a. Dismount the suction and discharge valves, clean them and replace, see position (fig. 10). Should the valves be swollen, check valves material against our chemical resistance compatibility chart and fit correct valves. Standard valves are Viton. Upon request ball check valve, can be supplied.*
- b. Check clogging of the filter.*

**ATTENTION:** *When removing the metering pump from the plant, be careful as there might be some residual additive in the discharge hose.*

### **9.2 - ELECTRICAL FAULTS**

#### **● 1 ● ALL LEDS OFF, THE PUMP DOES NOT PULSE**

*Check power supply (socket, plug, power switch ON), if the pump doesn't work contact manufacturer Customer Service, Dealer or Distributor.*

#### **● 2 ● GREEN LED (POWER) ON, RED LED (PULSE) OFF, THE PUMP DOES NOT PULSE**

*Check that the pump is not in Alarm (yellow LED flashing, on display LEVEL has appeared), verify the calibration's parameters. If the pump doesn't work contact Manufacturer Customer Service, Dealer or Distributor.*

#### **● 3 ● PUMP PULSES ARE NOT CONSTANT**

*Check that supply voltage is within +/- 10% of rated voltage.*

#### **● 4 ● THE DOSING PUMP GIVES ONLY ONE PULSE**

*Disconnect the equipment and contact manufacturer Customer Service, Dealer or Distributor.*