

Operation Manual 0/4-20mA Input and Temperature Transmitter

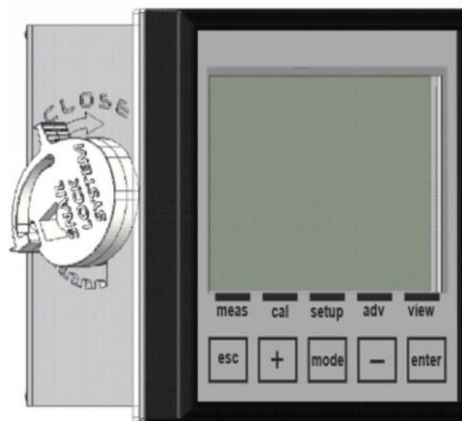

DosingPump.ir

GENERAL	4
INFORMATION REGARDING THE MANUAL	4
LIMITATIONS OF USE AND SAFETY PRECAUTIONS	4
INFORMATION ON RECYCLING AND USE OF MATERIALS.....	6
GENERAL DESCRIPTION	7
MAIN CHARACTERISTICS.....	8
CONTROLS, INDICATORS AND CONNECTIONS	9
GRAPHIC DISPLAY	10
INSTALLATION	11
INSTALLING THE CENTRAL UNIT ON THE WALL.....	11
INSTALLING THE CENTRAL UNIT ON A PANEL	13
CONNECTION TO THE POWER SUPPLY	14
CONNECTION TERMINAL BLOCK FOR THE WALL MOUNTED DEVICE	15
STARTUP.....	17
ALARMS MENU.....	18
INFO MENU.....	18
CALIBRATION MENU (INDEX MENU 1).....	18
CALIBRATION PROCEDURE	20
CALIBRATION ERRORS.....	25
SETUP MENU (INDEX MENU 2)	27
SETUP MENU \ RELAY 1 (ONE) (INDEX MENU 2A).....	28
SETUP MENU \RELAY 2 (TWO) (INDEX MENU 2B).....	29
SETUP MENU SSR1 AND SSR2 (INDEX MENU 2C AND 2D).....	30
SETUP MENU \ OUTPUT MA1 AND MA2 (INDEX MENU 2E AND 2F)	31
ADVANCED MENU (INDEX MENU 3)	32
ADVANCED MENU \ LANGUAGE (INDEX MENU 3A).....	33
ADVANCED MENU \ PASSWORD (INDEX MENU 3B)	34
ADVANCED MENU \ DISPLAY (INDEX MENU 3C).....	35
ADVANCED MENU \ MEASURE (INDEX MENU 3D).....	36
ADVANCED MENU \ MEASURE RANGE (INDEX MENU 3E).....	38
ADVANCED MENU \ TEMPERATURE MEASURE (INDEX MENU 3F)	40
ADVANCED MENU \ ALARMS SETTING (INDEX MENU 3G).....	41
ADVANCED MENU \ OUTPUTS SETTING (INDEX MENU 3H).....	42
ADVANCED MENU \ RS485 PORT SETTING (INDEX MENU 3I).....	43
ADVANCED MENU \ USB PORT SETTING (INDEX MENU 3L)	45
ADVANCED MENU \ CONTROL PANEL (INDEX MENU 3M).....	45
ADVANCED MENU \ STATISTICS (INDEX MENU 3N)	46
ADVANCED MENU \ SYSTEM RESET (INDEX MENU 3O)	47
ADVANCED MENU \ FIRMWARE REVISION (INDEX MENU 3P).....	47
VIEW MENU (INDEX MENU 4).....	48
GENERAL SPECIFICATIONS	49
MECHANICAL SPECIFICATIONS FOR VERSION 1/4DIN	49
MECHANICAL SPECIFICATIONS FOR VERSION 1/2DIN	49
ENVIRONMENTAL SPECIFICATIONS FOR VERSION 1/2DIN & 1/4DIN.....	49

ELECTRICAL SPECIFICATIONS	50
ANNEX A: ON/OFF RELAY SETUP	51
ANNEX A: ON/OFF RELAY SETUP WITH PERMANENCE TIME AND OFA FUNCTION	52
ANNEX B: TIMED RELAY SETUP	53
ANNEX B: TIMED RELAY SETUP WITH PERMANENCE TIME AND OFA FUNCTION.	54
ANNEX C: PROPORTIONAL (PWM) RELAY SETUP	55
ANNEX C: PROPORTIONAL (PWM) RELAY SETUP WITH PERMANENCE TIME AND OFA FUNCTION.....	56
ANNEX D: RELAY 2 SETUP FOR AUTOMATIC WASHING.....	57
ANNEX E: RELAY 2 SETUP TO REPEAT REMOTE ALARM.....	58
ANNEX F: SSR1 AND SSR2 SETUP	59
ANNEX G: MA1 AND MA2 SETUP	60
ANNEX H: WIRING EXAMPLES.....	61
ANNEX I: TROUBLESHOOTING.	63
ANNEX L: DEFAULT PARAMETERS TABLE AND RESET TO DEFAULT.....	64
RESET THE DEFAULT PARAMETERS OF THE INSTRUMENT	68
MODBUS PROFILE.....	69



Note: All the strings representing programming menus in this manual are indicative only. The strings displayed by the instrument have been shortened for proper readability and viewing on the display.

GENERAL

INFORMATION REGARDING THE MANUAL

Compliance with the operative procedures and the precautions described in this manual is an essential requirement for the correct operation of the instrument and to guarantee total operator safety.

Before using the instrument, the manual must be read in all of its parts, in the presence of the instrument itself, in order to ensure that the operating modes, the controls, the connections to the peripheral equipment and the precautions for safe and correct use are clearly understood.

The user manual must be stored, integral and legible in all parts, in a safe place which can be quickly and easily accessed by the operator during installation, use and/or installation revision operations.

CONVENTIONS

The present user manual uses the following conventions:

NOTE



The notes contain important information to be highlighted in comparison to the rest of the text. These generally contain information that is useful to the operator to carry out and optimize operating procedures of the equipment in a correct manner.

WARNING



Warning messages appear in the manual before procedures or operations that must be observed in order to avoid any possible losses of data or damages to the equipment.

ATTENTION



Attention messages appear in the manual in correspondence to description of procedures or operations which, if carried out incorrectly, may cause damages to the operator or users.

LIMITATIONS OF USE AND SAFETY PRECAUTIONS

In order to guarantee operator safety and correct device functionality, all of the usage limitations and precautions listed below must be respected:

ATTENTION



Make sure that all the safety requirements have been met before using the device. The device must not be powered on or connected to other devices until all of the safety conditions have been met.

ELECTRICAL SAFETY

ATTENTION



All of the control unit's connections are isolated from the grounding system (non-insulated grounding conductor).
DO NOT connect any of these connections to the grounding connector.

DosingPump.ir

In order to guarantee maximum conditions of safety for the operator, it is recommended to follow all of the indications listed in this manual.

- **Only power the device using a mains power supply that complies with the device's specifications (85÷265Vac 50/60Hz or 12÷32Vdc (24Vac±10%)).**
- **Replace any damaged parts immediately.** Any cables, connectors, accessories or other parts of the device which are damaged or not functioning properly must be replaced immediately. In such cases, contact your nearest authorized technical assistance center.
- **Only use specified accessories and peripherals.** In order to guarantee all of the safety requirements, the device must only be utilized in conjunction with the accessories specified in this manual, which have been tested for use with the device itself. The use of accessories and consumption materials from other manufacturers or not specifically recommended by supplier will not guarantee the safety and correct operation of the equipment. Only use peripherals that comply with the regulations of their specific categories

SAFETY OF THE OPERATING ENVIRONMENT

- The panel of the control unit is resistant to liquids. The device must be protected against drips, sprays and/or immersion and should not be used in environments where such risks are present. Any devices into which liquids may have accidentally penetrated must be immediately shut off, cleaned and inspected by authorized and qualified personnel.
- The transparent panel should be closed once the device has been programmed.

Protection

For **Wall Mounted** device (1/2 DIN)

- IP65 Complete
- EMI /RFI CEI EN55011 - 05/99 Class A

For **Panel Mounted** device (1/4 DIN)

- IP65 Front and IP20 Back
- EMI /RFI CEI EN55011 - 05/99 Class A

The device must be utilized within the specified environmental temperature, humidity and pressure limits. The instrument is designed to operate under the following environmental conditions:

- | | |
|---|-------------------------|
| - Temperature of the working environment | -10 ÷ +50°C |
| - Storage and transport temperature | -25°C ÷ +65°C |
| - Relative Humidity Box 96x96 (1/4 DIN) | 0% ÷ 95% Non-Condensing |
| - Relative Humidity Box 144x144 (1/2 DIN) | 0% ÷ 100% Condensing |

ATTENTION

The device must be perfectly inserted into the system.

The system must be maintained operational in full compliance with the foreseen safety regulations.

The parameters set on the analyzer's control unit must comply with the current regulations.

The control unit's malfunction signals must be located in an area that is constantly supervised by the system's maintenance personnel or operators.

Failure to respect even just one of these conditions could cause the control unit's "logic" to operate in a potentially dangerous manner for the users of the service.

In order to avoid any potentially dangerous situations, therefore, the system's service and/or maintenance personnel are advised to work with the utmost care and to signal any alterations in the safety parameters in a timely manner.

As the above issues cannot be monitored by the product in question, the manufacturer shall bear no responsibility for any property damage or personal injury which may result from such malfunctions.



ATTENTION SYMBOL

The symbol illustrated below represents the **ATTENTION** symbol and reminds the operator that he should read the user manual for important information, advice and suggestions regarding the correct and safe use of the equipment.



In particular, when it is positioned close to connection points to cables and peripherals, the symbol in question refers to careful reading of the user manual for instructions related to the nature of such cables and peripherals and the methods for correct and safe connection.

The reproductions of equipment panels, with relative commands, connections, symbols and labels are provided in this chapter. Each attention symbol is accompanied by a detailed explanation of its meaning.

PLATE DETAILS

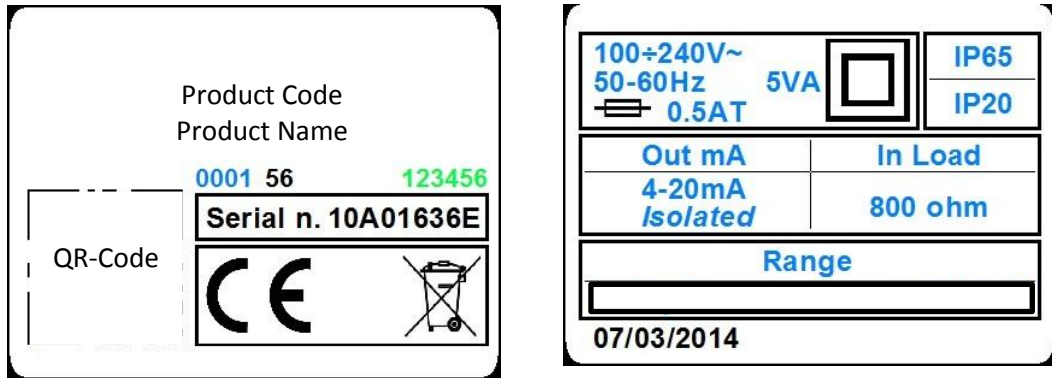

INFORMATION ON RECYCLING AND USE OF MATERIALS

The supplier, in accordance with specific European regulations, aims at constant improvement of development and of production procedures of its equipment with the objective of drastically reducing the negative impact on the environment caused by parts, components, consumption materials, packaging and the equipment itself at the end of its life cycle.

The packages are designed and produced to allow the reuse or recovery, including recycling, of the great part of the materials and to minimize the amount of waste or residues to be disposed. In order to assure a correct environmental impact, the equipment has been designed with the smallest circuit possible, with the lowest differentiation of materials and components, with a selection of substances that guarantee utmost recycling and maximum reuse of the parts and waste disposal free from ecological risks.

The equipment is made in such a way as to guarantee the easy separation or dismantling of the materials containing contaminants in comparison with others, in particular during maintenance operations and the replacement of components.

ATTENTION



The disposal/recycling of packages, consumption materials and of the equipment itself at the end of its life cycle must be carried out in accordance to the standards and regulations currently in force in the country where the equipment is used.

SPECIAL ATTENTION TO CRITICAL COMPONENTS

The instrument is provided with a liquid crystal display LCD, which contains small amounts of toxic materials.

DosingPump.ir

GENERAL DESCRIPTION

The analyzer treated in this manual consists of an Electronic Control Unit and a Technical Manual. It is powered from the mains (100 ÷ 240 Vac 50-60 Hz), with a power consumption of 5W, through a switching power supply.

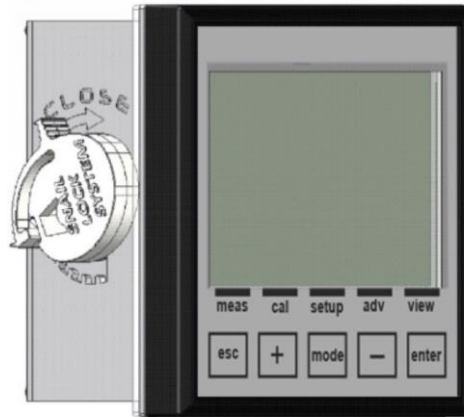

Figure 1 – Wall mounted Central Unit

MAIN CHARACTERISTICS

- mA input for 0/20mA or 4/20mA sensors with two or three wires.
- Temperature Measure with PT100 / PT1000 Probe
- Programming keyboard with 5 keys
- Graphic Display, 128x128 pixels, with three colors backlight (white, green and red)
- Serial Output RS485 MODBUS RTU/ASCII (upon request)
- 2 Programmable Analog Outputs
- 2 Frequency Programmable Digital Outputs
- 2 Relay Outputs for Intervention Thresholds, Wash and Remote Alarm
- 2 Digital Inputs for blocking the dosages

TECHNICAL SPECIFICATIONS FOR THE mA MEASURE (PRIMARY)

Sensor	Current Sensor with 2 or 3 wires
Measure Range	0/20mA or 4/20mA
Resolution	±1µA
Precision	±10µA

TECHNICAL SPECIFICATIONS FOR THE TEMPERATURE MEASURE (SECONDARY)

Sensor	PT100/PT1000
Measure Range	-50 ÷ +150°C
Resolution	± 0.1°C (°F)
Precision	PT100: ±0.5°C (±0.9°F) – PT1000: ±0.2°C (±0.4°F)

OPERATING SPECIFICATIONS

Power Supply	00÷240 Vac 50-60 Hz or 12÷32 Vdc (24Vac ±10%)
Power Consumption	< 5W (@100÷240Vac) and <3.5W (@12÷32Vdc)
Relay Outputs:	
Alarms:	
Function	Delay, Faults and Min./Max
Delay Time	1÷3600sec
Threshold disabling	Enable / Disable
Relay function	Closed / Open
Permanence Interval	-99999 ÷ 99999
Permanence Time	1÷3600sec For Alarm and Wash it is used the relay n. 2 with normally open contact.
HOLD Digital Input:	
Input Voltage	12÷32 Vdc
Absorption	10mA max
Analog Outputs:	
Outputs	n.2 4-20mA Programmable
Maximum Load	800 Ohm
NAMUR Alarm Output	3.6 mA or 22 mA
Hold Alarm Value	

DosingPump.ir

CONTROLS, INDICATORS AND CONNECTIONS

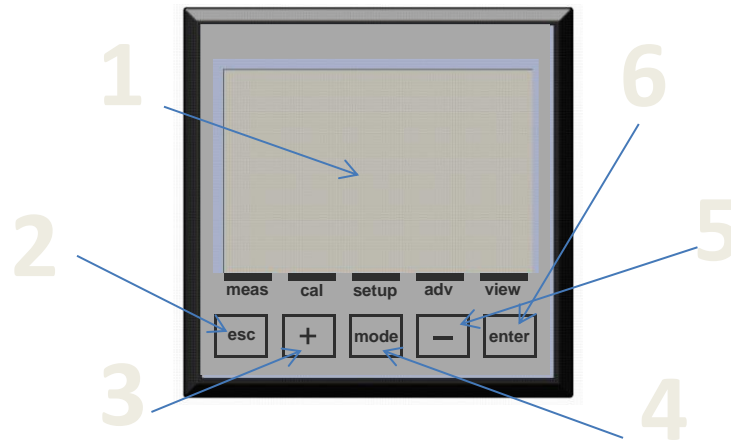

Figure 2 – Instrument

1. Visualizer with LCD Display
2. ESC key: Reject parameter or exit the programming menu
3. UP key: Increase value
4. MODE key: Select menu with icon on the status bar
5. DOWN key: Decrease value
6. ENTER key: Confirm parameter or access the programming menu

GRAPHIC DISPLAY SUBDIVISION AREAS IN RUN MODE

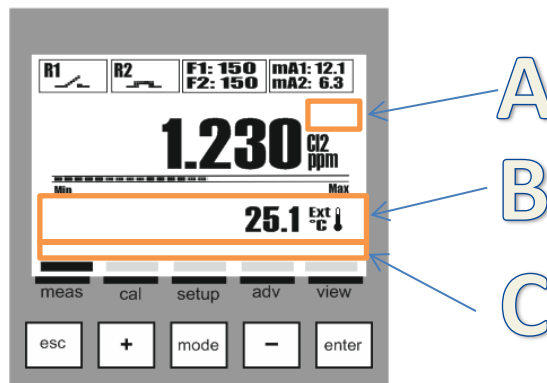

Figure 3 – Graphic Display - Subdivision Areas

In the standard view of the instrument we have three areas, as follows:

- A) Service icons such as Danger, Maintenance, Wait Time, Data Transmission.
- B) Text messages for Alarms and operation information or temperature value with external sensor (ext) or manually set value (man).
- C) Menu name associated to the icon on the status bar



DosingPump.ir

GRAPHIC DISPLAY

The graphic display allows a series of views for the various menus, for programming and for viewing during operation (run).

LIST OF THE MAIN MENUS

The following table shows the screens visualized on the display representing the different menus

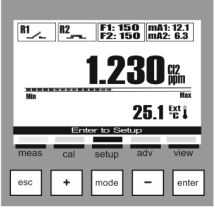
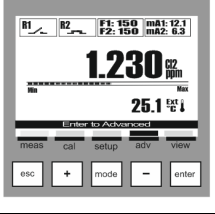
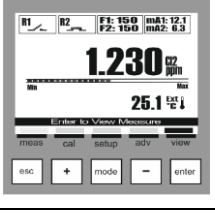
VISUALIZATION ON THE GRAPHIC DISPLAY	DESCRIPTION
	VIEW MEASURE
	CALIBRATION MENU Sensor Calibration Procedure
	SETUP MENU Output Parameters Setup
	ADVANCED MENU Device Configuration Menu
	VIEW MENU Measure Visualization Setting



Note: Automatic exit from menu after 5 minutes of inactivity without saving data.

INSTALLATION

Before installing, read carefully what is written below.



INSTALLING THE CENTRAL UNIT ON THE WALL

The wall must be very smooth to allow the perfect adhesion of the central unit.

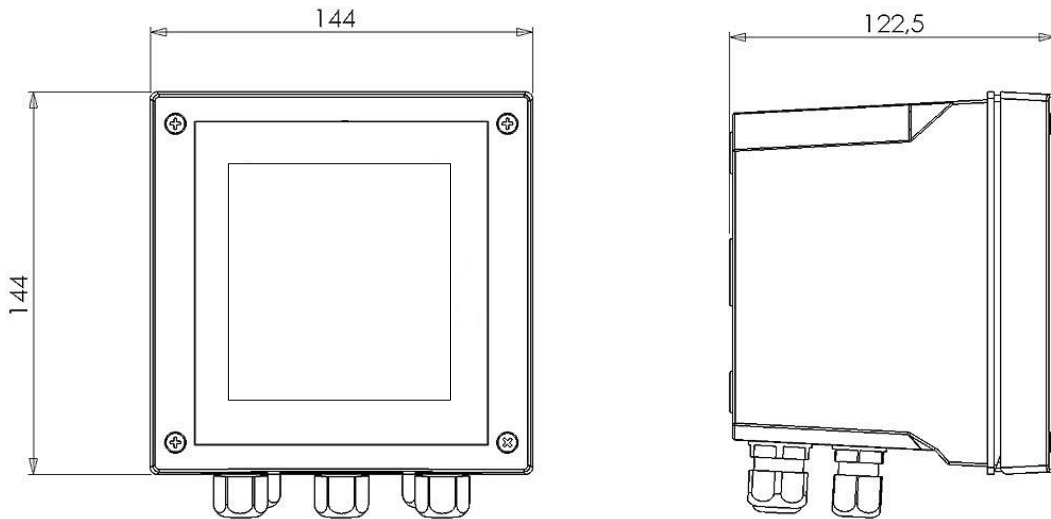

Figure 4 – Dimensions and footprint for wall mounted central unit

Mechanical Dimensions	
Dimensions (L x H x P)	144x144x122,5mm
Fixing depth	122,5mm
Material	ABS
Mounting	Wall
Weight	0,823 Kg
Front Panel	UV Resistant Polycarbonate

Open the instrument, drill the necessary holes and fasten the instrument to the wall. Cover the holes internally with the corresponding caps supplied with the instrument.

The cable glands for the electrical connections are located on the lower part of the control unit and therefore, in order to facilitate the connections, any other devices must be positioned at least at 15 cm away.



Protect the device against any drips and/or sprays of water from adjacent areas during the programming and calibration phases.



Note: The BOX 144x144 is a plastic accessory, an IP65 certified item to be purchased separately.

DosingPump.ir

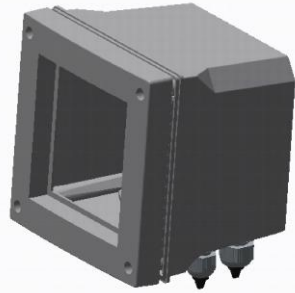
Example: Assembling the instrument 96x96 into the accessory Box 144x144 with IP65 protection

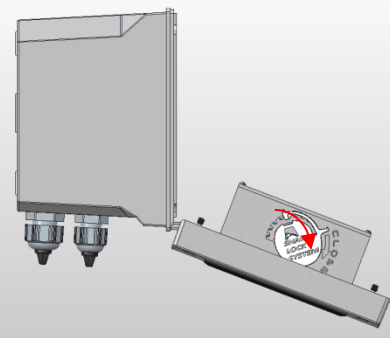
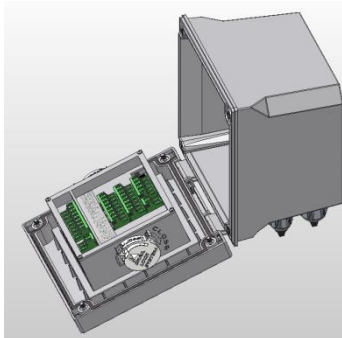
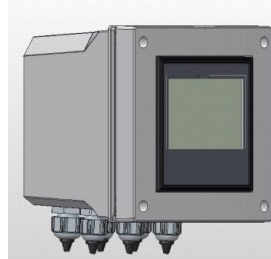
 <p>Instrument 96x96</p>	 <p>Accessory Box 144x144</p>	 <p>Open the front door</p>
 <p>Secure the instrument and lock the snails.</p>	 <p>Verify locking from all sides</p>	 <p>Close the front door</p>

INSTALLING THE CENTRAL UNIT ON A PANEL

The wall must be very smooth to allow the perfect adhesion of the electrical panel where the central unit will be fitted.

The fixing depth of the panel must be at least 130 mm.

The thickness of the panel must not exceed 5 mm.

The panel cutout must comply with the following layout:

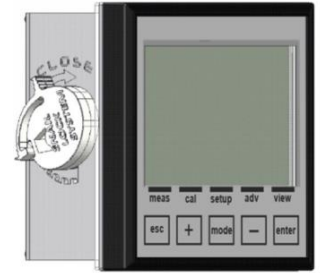
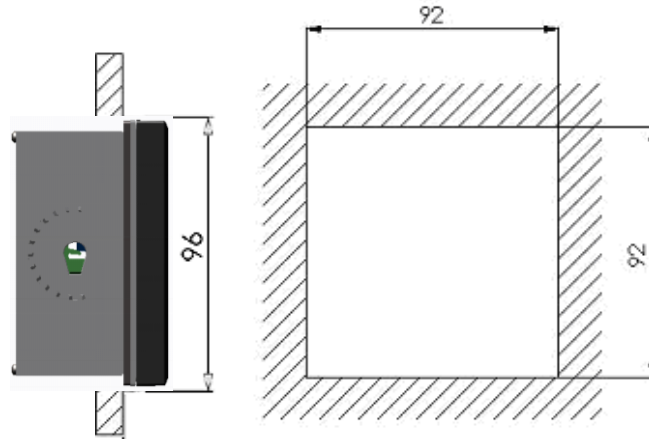

Figure 5 – Panel cutout and dimensions

Mechanical Dimensions	
Dimensions (L x H x P)	96x96x42mm
Fixing depth	130mm
Material	ABS
Mounting	Panel
Weight	0.4 Kg
Front Panel	UV Resistant Polycarbonate



The central unit can be locked on the panel using the two clamps supplied with the unit, inserted in their seats and locked with corresponding screws.



Figure 6 – Panel Mounted Central Unit with Snail Lock System

DosingPump.ir

CONNECTION TO THE POWER SUPPLY

If possible, keep any high power cables away from the instrument and its connection cable (these could cause inductive disturbances, especially for the analogical part of the system).

Use an alternating 100Vac to 240Vac-50/60Hz power supply – or as specified on the plate. The power supply must be as stabilized as possible.

Absolutely avoid connecting the device to rebuilt power supplies, using transformers for example, where the same power supply is also used to power other systems (perhaps of an inductive typology); this could lead to the generation of high voltage spikes which, once emitted, are difficult to block and/or eliminate.

ATTENTION



The electrical line must be equipped with an appropriate circuit breaker, in compliance with the proper installation standards

It is nevertheless always a good idea to check the quality of the grounding connector. In industrial facilities, it is not uncommon to find grounding connectors that cause electrical disturbances instead of preventing them; wherever doubts should arise regarding the quality of the facility's grounding connectors, it is better to connect the control unit's electrical system to a dedicated grounding rod.

Electric connections to the dosing systems (Utilities)

ATTENTION



Before connecting the instrument to the external Utilities, make sure that the electrical panel is turned off and that the wires from the Utilities are not live.

The term "Utilities" refers to the relay outputs used in the control unit

- (SET1) for the operation of dosing pumps or control
- (SET2) for the operation of dosing pumps or control
- (ALARM) alarm command sent by the instrument to siren and/or flashing light
- (WASH) command to the washing device

WARNING



With a resistive load, each relay contact can sustain a maximum current of 5 Ampere at max. 230V.

In case of higher powers, it is advisable to make the connection with the Utilities as indicated in Annex H.

If, on the contrary, the load to be controlled is in any case of a low power or of a resistive type, you can proceed as indicated in Annex H.

CONNECTION TERMINAL BLOCK FOR THE WALL MOUNTED DEVICE

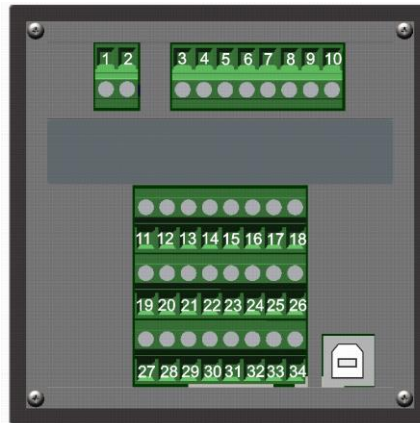

N° (TERMINAL)	Symbols	DESCRIPTION
1	L / +	Power supply (Phase)
2	N / -	Power supply (Neutral)
3	SSR1 (+)	Frequency output 1 (SSR1 +)
4	SSR1 (-)	Frequency output 1 (SSR1 -)
5	SSR 2 (+)	Frequency output 2 (SSR 2 +)
6	SSR 2 (-)	Frequency output 2 (SSR 2 -)
7	RL1 NO	Relay 1 Contact
8	RL1 COM	Relay 1 Contact
9	RL2 COM	Relay 2 Contact
10	RL2 NO	Relay 2 Contact
11	OUT mA1 (+)	Current output 1 (OUT mA1 +)
12	OUT mA1 (-)	Current output 1 (OUT mA1 -)
13	OUT mA2 (+)	Current output 2 (OUT mA2 +)
14	OUT mA2 (-)	Current output 2 (OUT mA2 -)
15	NOT USED	Not Used
16	RS485 (B+)	Serial Port for Data (RS485 B+) (optional on request)
17	RS485 (A-)	Serial Port for Data (RS485 A-) (optional on request)
18	RS485 (GND)	Serial Port for Data (RS485 GND) (optional on request)
19	+ 5VDC	(* Flow Sensor Power Supply (+ 5VDC)
20	INPUT Freq1	(* Flow Measure Input (INPUT Freq1)
21	INPUT DIR1	(* Flow Measure Input (INPUT DIR1)
22	GND	(* Flow Sensor Power Supply (GND)
23	HOLD (+)	12÷32 VDC HOLD Signal Input (+)
24	HOLD (-)	12÷32 VDC HOLD Signal Input (-)
25	REED (+)	REED Sensor Input (+)
26	REED (-)	REED Sensor Input (-)
27	+18V	Power supply output for sensor (Max. 50mA)
28	IN mA	Current input for sensor (0/20mA or 4/20mA)
29	GND mA	Used to connect the three-wire sensors
30	NOT USED	NOT USED
31	NOT USED	NOT USED
32	RTD (+)	PT100 or PT1000 Temperature Probe Input
33	RTD SENSE	PT100 or PT1000 Temperature Probe Input
34	RTD GND	PT100 or PT1000 Temperature Probe Input
USB	USB PORT	(* USB Port for Software Update

(*Input or Output unavailable)

DosingPump.ir

Terminal block connections

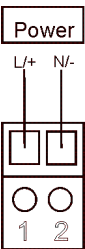
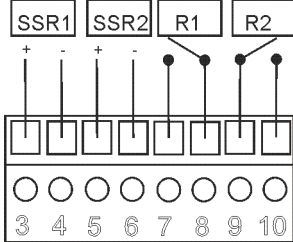
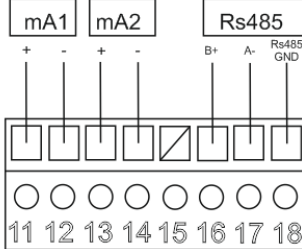
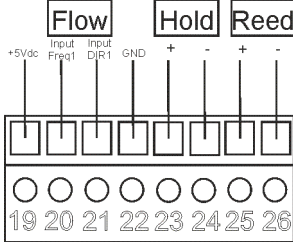
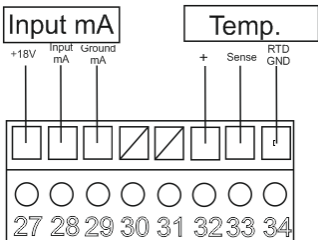
Description	Graphic
<p>Instrument Power Supply Input: 100÷240 Vac or 12÷32 VDC (24Vac) Note: Check the product label.</p>	
<p>Outputs: SSR1 and SSR2: Solid State Relays (400Vac/dc, 125mA) R1 and R2: Electromechanical Relays (250Vac or 30VDC, 5A Resistive)</p>	
<p>Outputs: mA1 and mA2: Current Outputs 4÷20mA (800 ohm) RS485: Serial Port for Data Communication (upon request)</p>	
<p>Inputs: Flow: Flow Sensor Input (upon request) Hold: 12÷32 Vdc Signal Input Reed: Dry Contact Signal Input</p>	
<p>Inputs: mA Input: Current Sensor with 2 or 3 wires Temp: Temperature Measure Input PT100 or PT1000</p>	

(Note: See ANNEX H for Wiring Examples)

SENSOR CONNECTION



Turn off the instrument. Connect the cable of the sensor to the terminal block of the instrument. It is also a good idea not to pass the cable near high power or inverter cables in order to avoid interference problems with the measure.

STARTUP

The instrument performs a hardware test of the internal memory and displays the message "**Read data memory**"

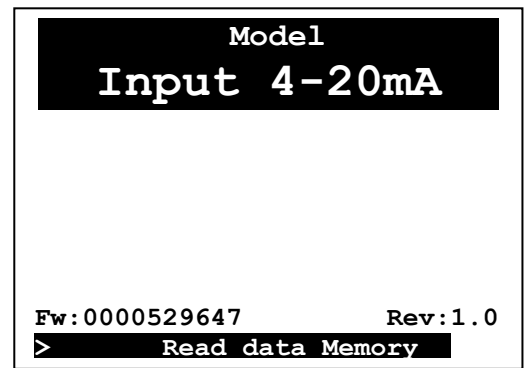

Wait

The instrument enables all the measure functions within 5 seconds.

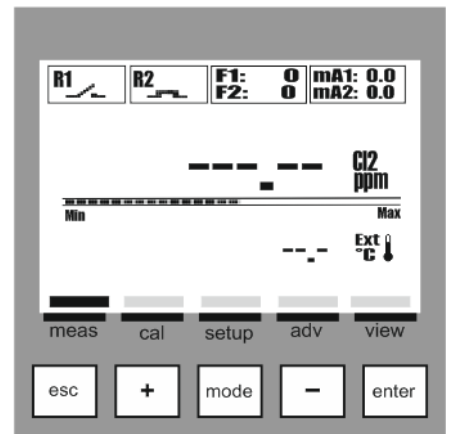

View Measure and Outputs Activation

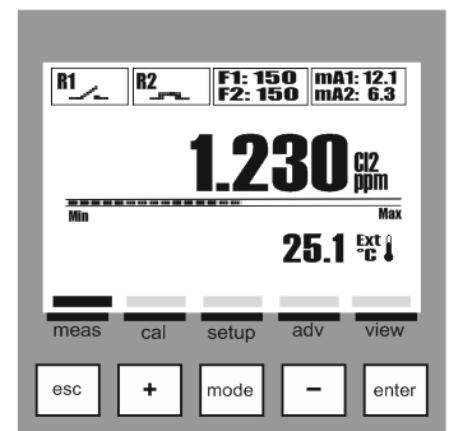



ALARMS MENU

On View measure menu there is available an alarm menu which displays the alarm status by pressing the Enter key; the **Alarms Menu** consists of six (6) items or sub-menus:

- A:** View Log: list of all recorded alarms, starting with the most recent
- B:** Reset Log: deletes all alarm events
- C:** Reset OFA: deletes the OFA alarm and resets the counter
- D:** Reset Permanence: deletes the alarm
- E:** Reset Service: deletes the alarm and resets the counter
- F:** Reset RL2 (used as alarm):

Scroll through the menu using the **(+)** or **(-)** key, select the item and confirm with the **Enter key**.

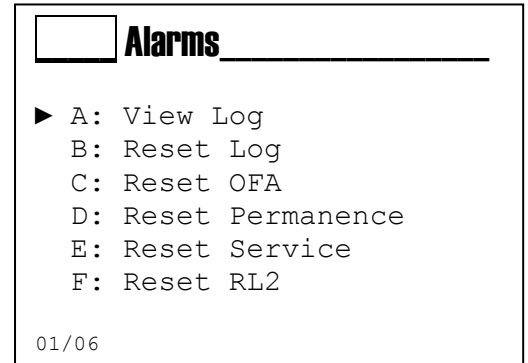

INFO MENU

In view measure mode, press the ESC key to access the Info menu.

Select the item "Download Manual" and press the Enter key.



On the screen will be displayed the QR Code with which you can start downloading the user manual in pdf format.



CALIBRATION MENU (INDEX MENU 1)

Use the MODE key to scroll through the icons on the status bar, from left to right, select the **Calibration** menu.

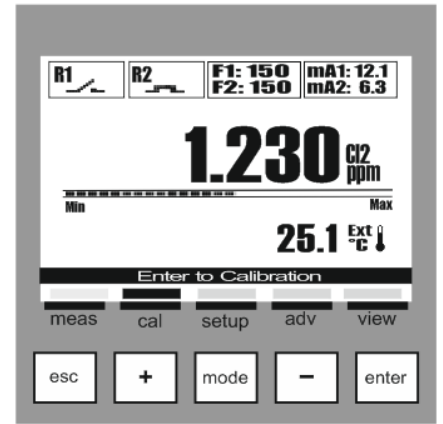

Calibration Menu 1

The Calibration menu consists of two (2) items or sub-menus:

A: Measure

B: Temperature

Scroll through the menu using the **(+)** or **(-)** key, select the item and confirm with the **Enter** key.

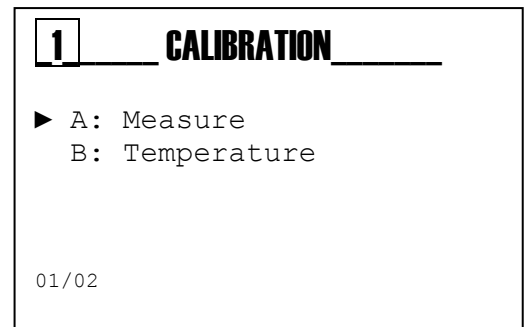

Calibration Menu 1 Measure (Menu 1A)

The Measure Calibration menu consists of five (5) items or sub-menus:

1A1: 1 Point Cal: One measure point calibration.

1A2: 2 Points Cal: Two measure points calibration.

1A3: Reference: Allows you to refine the calibration by adding or subtracting an offset

1A4: Report: Will be displayed a summary of the last calibration.

1A5: Reset Calibration: The calibrations can be deleted and restored the default values.

Scroll through the menu using the **(+)** or **(-)** key, select the item and confirm with the **Enter** key.





CALIBRATION PROCEDURE

Calibration Menu Measure (Menu 1A)

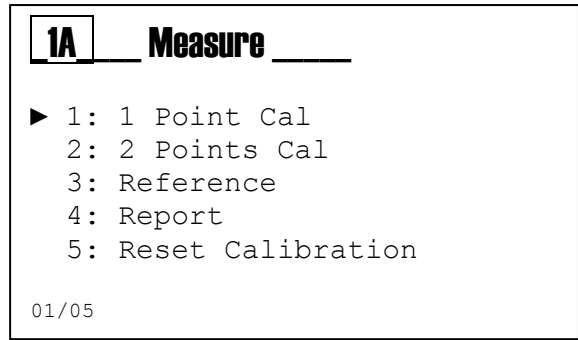

Menu 1A1 One Point Calibration

Check that the sensor is properly installed and it is measuring.

Press the **Enter** key when ready.

Wait for 60 seconds.

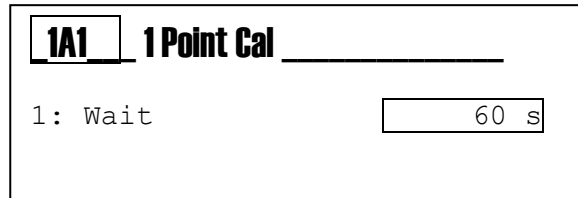

At the end of the countdown, insert the calibration value.



The instrument displays a numeric keypad to insert the known value.

Press the **Enter** key when ready.

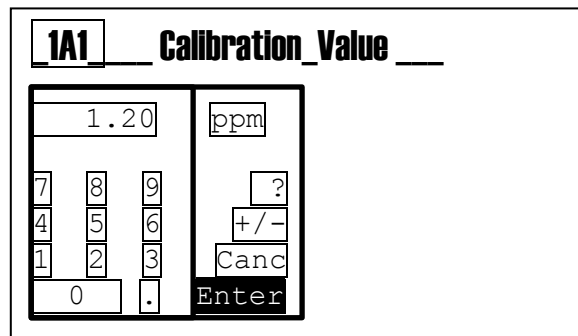

The instrument displays:

1: The calibration value used.

2: The calculated Gain value.

3: The calculated Offset value.

4: Enter to confirm and save all the calibration parameters.

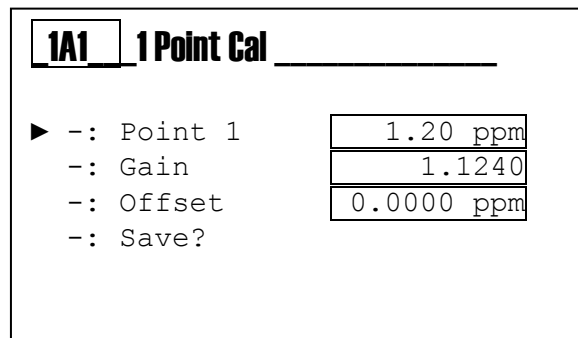

The instrument displays the question to confirm and save all the calibration data.

At the end the instrument returns to Calibration menu 1.

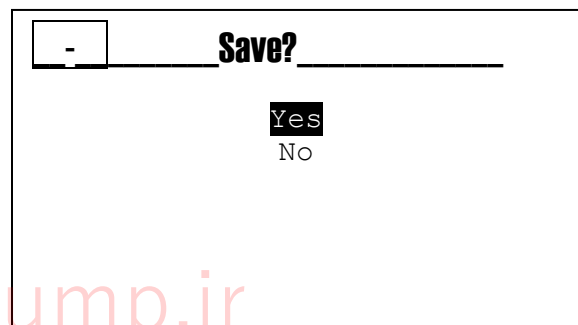

Menu 1A2 Two Points Calibration

Check that the sensor is properly installed and it is measuring.
Press the **Enter** key when ready.
Wait for 60 seconds.

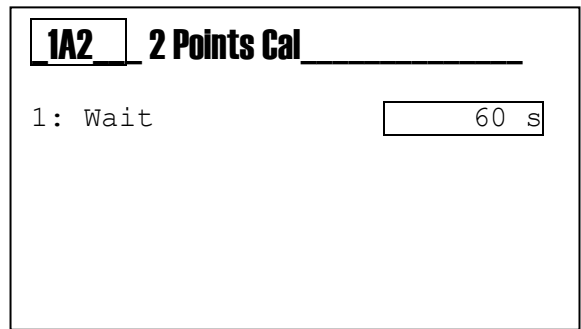

At the end of the countdown, insert the first calibration value.

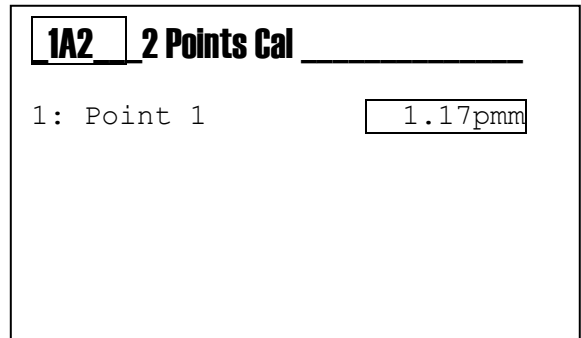

The instrument displays a numeric keypad to insert the known value.

Press the **Enter** key when ready.

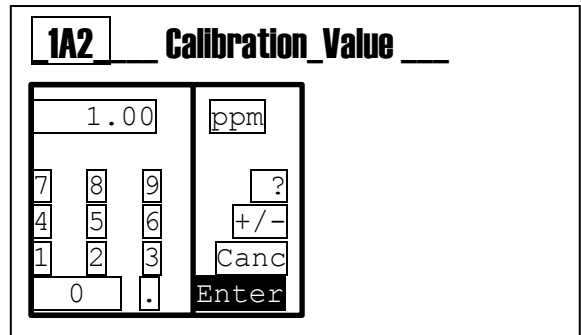

Prepare the second calibration point of the sensor.
Insert the sensor into the second buffer solution.
Press the **Enter** key when ready.

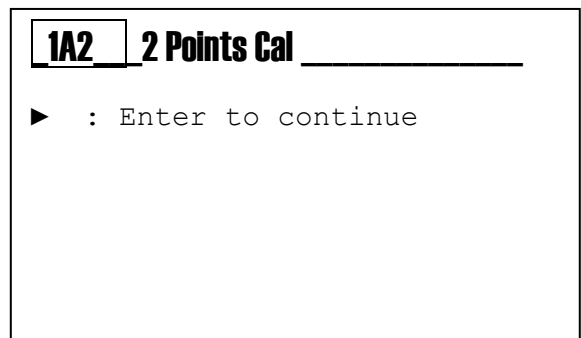

Wait for 60 seconds.

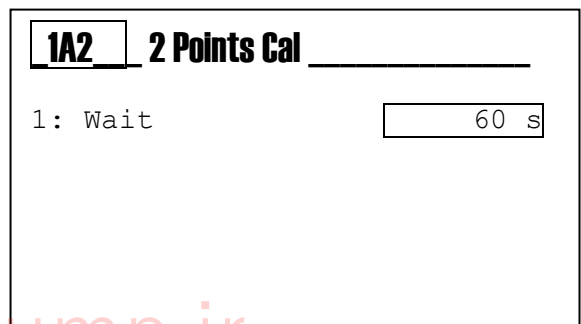

At the end of the countdown, insert the second calibration value.

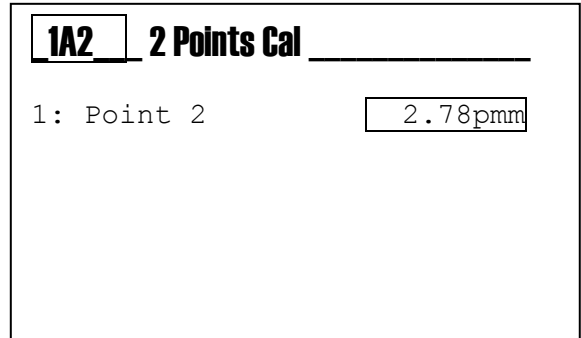

The instrument displays a numeric keypad to insert the known value.

Press the **Enter** key when ready.

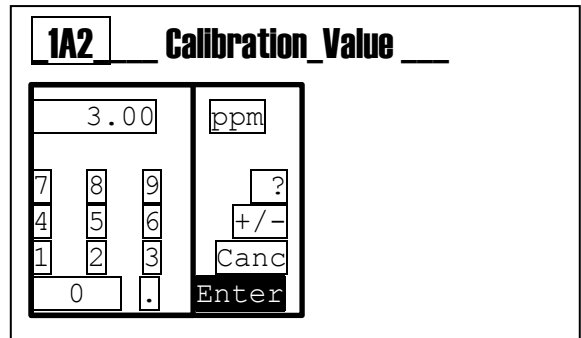

The instrument displays:

- 1: The calibration value used for the first point.
- 2: The calibration value used for the second point.
- 3: The calculated Gain value.
- 4: The calculated Offset value.
- 5: Enter to confirm and save all the calibration parameters.

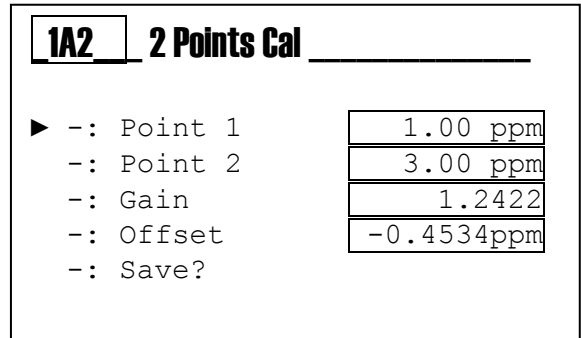

The instrument displays the question to confirm and save all the calibration data.

At the end the instrument returns to Calibration menu 1.

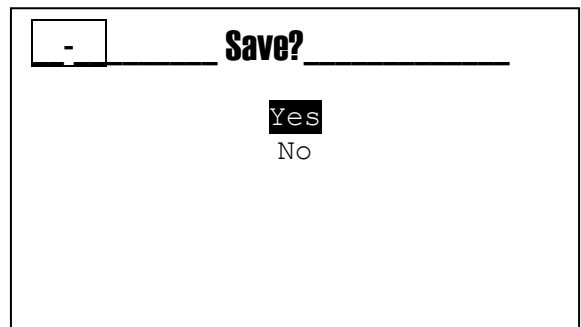

Menu 1A3 Reference Calibration

Check that the sensor is properly installed and it is measuring.
Press the **Enter** key when ready.

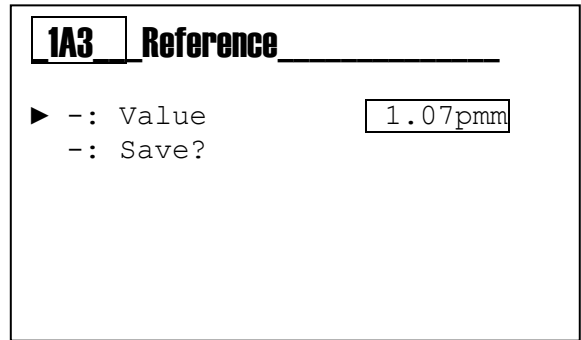

The instrument displays a numeric keypad to insert the known value.

Press the **Enter** key when ready.

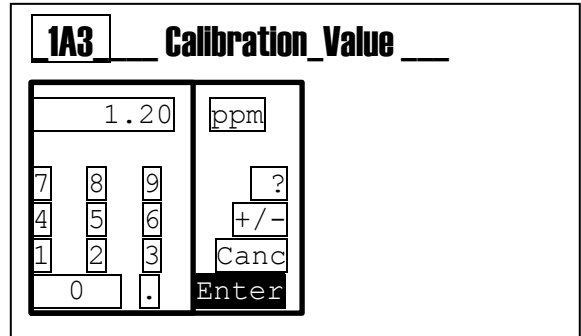

The instrument displays:
1: The calibration value.
2: Enter to confirm and save all the calibration parameters..

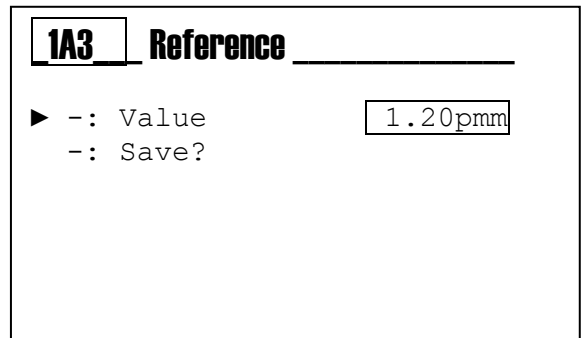

The instrument displays the question to confirm and save all the calibration data.

At the end the instrument returns to Calibration menu 1.

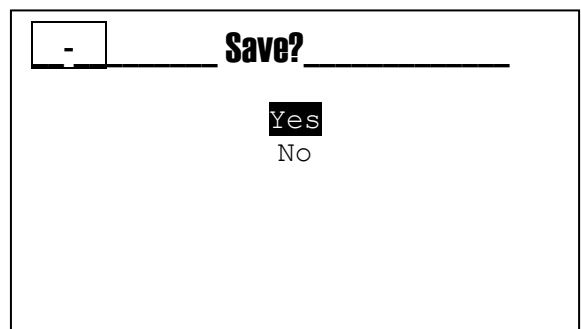

Menu 1A4 Report

The calibration report displays all the parameters related to the last calibration.

Calibration Type: Indicates the calibration type,

- None
- 1 Point
- 2 Points

Point 1: Indicates the value entered for point 1.

Point 2: Indicates the value entered for point 2.

Gain: Indicates the calculated angular coefficient.

Offset: Indicates the calculated offset value.

Adjust: Indicates the offset value memorized through the "Reference" calibration type.

1A4 Report	
Cal. Type	2 Points Cal.
Point 1	1.00ppm
Point 2	3.00ppm
Gain	1.2422
Offset	-0.453ppm
Adjust	0.130ppm



Note: When the calibration is performed for 1 Point or 2 Points, the "Adjust" value is automatically reset to zero.

Menu 1A5 Reset Calibration

This function allows the user to delete all the calibrations and to restore the default values.

1A5 Reset_Cal	
Are you sure?	
NO	
YES	

CALIBRATION ERRORS



Power Supply +18V is in Short:

- Damaged wiring
- Sensor is in Short

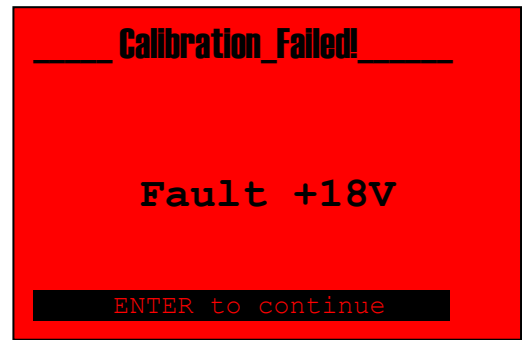

mA Input less than 3.6mA:

- Damaged wiring
- Sensor missing



Note: This alarm is active only if:

- The input current is lower than 3.6mA
- The menu 3E1 is set to 4-20mA
- The menu 3E5 is set to 3.6mA

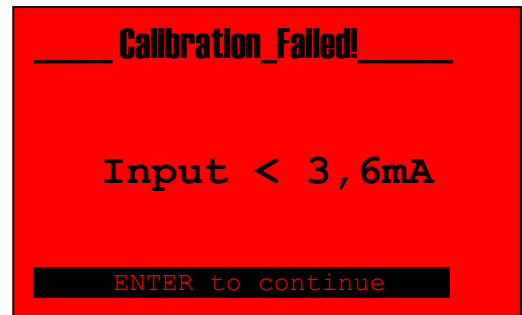

mA Input greater than 22mA:

- Damaged wiring
- Sensor missing



Note: This alarm is active only if:

- The input current is higher than 22mA
- The menu 3E4 is set to 22mA

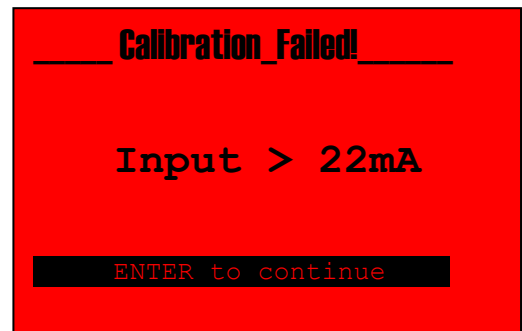

The set values must not coincide:

- Only for the 2 points calibration, the values set from numeric keypad must not coincide.

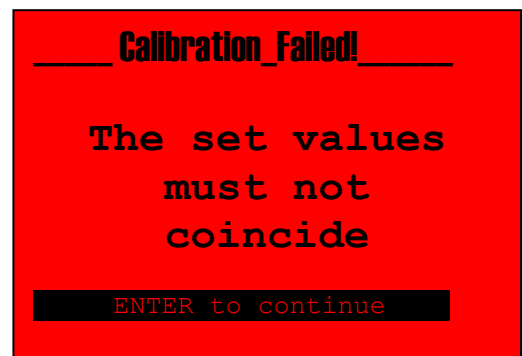

The two calibration points must differ by at least 10%:

- The second calibration point must be greater with at least 10% compared to the first calibration point.

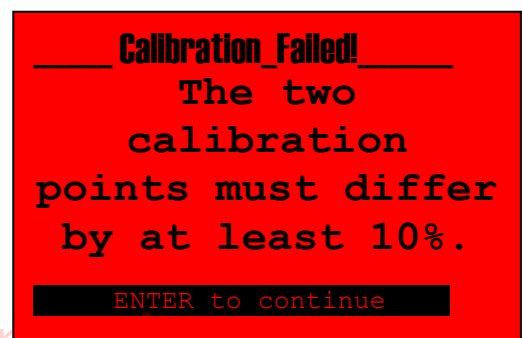

The set values must be different from zero:

- Only for the 1 point calibration, the values set from numeric keypad must be different from zero.

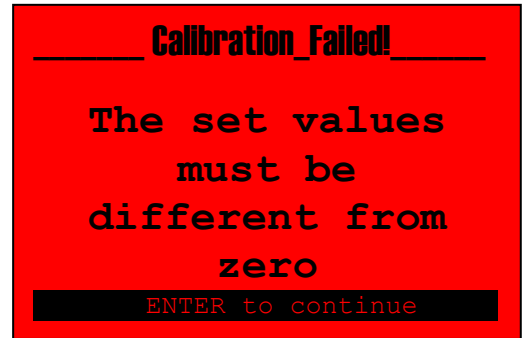

Temperature Measure Calibration Menu (Menu 1B)

Menu 1B

Calibration of the Temperature Measure with an external reference value, manually set. The instrument performs a correction of the value by adding an offset value to the real measure.

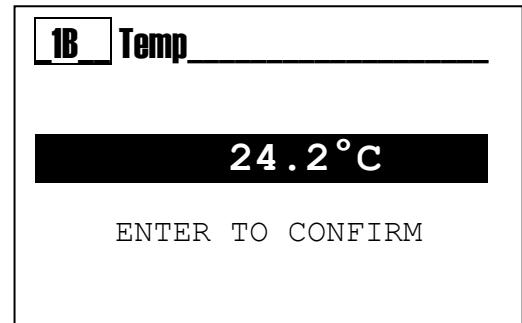

Menu 1B

The instrument displays the message "Calibration Failed" if the probe is damaged or disabled from the menu 3E1; see manual, the Advanced Menu section.

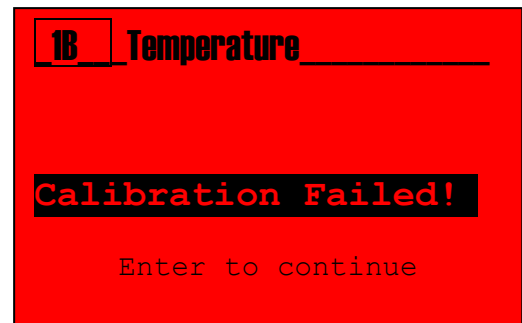

SETUP MENU (INDEX MENU 2)

Use the **MODE** key to scroll through the icons on the status bar, from left to right, select the **setup** menu and confirm with the **Enter** key.

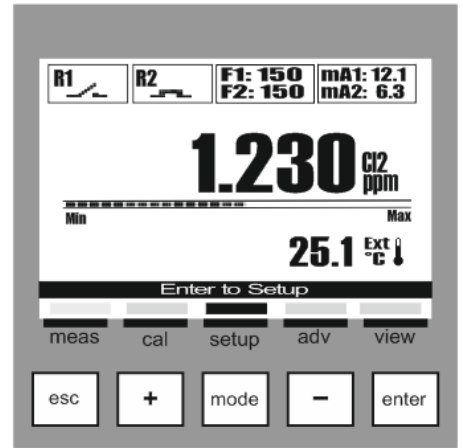

The Setup menu consists of six (6) items or sub-menus:

- 2A: Relay 1
- 2B: Relay 2
- 2C: SSR1 (Solid State Relay)
- 2D: SSR2 (Solid State Relay)
- 2E: Output mA1 (Range 4÷20 mA)
- 2F: Output mA2 (Range 4÷20 mA)



Note: To set the relative function to each output, read the manual at the **Advanced Menu\Outputs Configuration** section (INDEX MENU 3H).

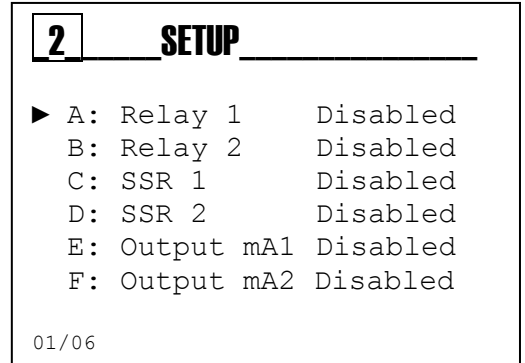

Below are illustrated the settings required for each sub-menu indicated above.

To exit the menu, press the **Esc** key; when at least one parameter has been changed, the instrument will display the question “save?”; confirm with the **Enter** key.

For not saving, select NO using the (+) or (-) key and confirm with the **Enter** key.

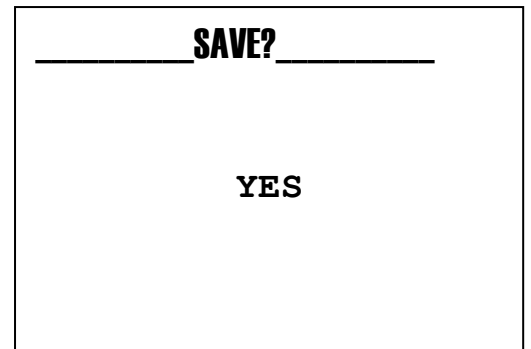

SETUP MENU \ RELAY 1 (ONE) (INDEX MENU 2A)

Scroll through the menu using the **(+)** or **(-)** key, select the item Relay 1 and confirm with the **Enter** key.

Scroll through the menu using the **(+)** or **(-)** key, select the item and confirm with the **Enter** key.

The **Relays 1** and **2** can be set either for mA Measure or for Temperature Measure with the following activation methods:

ON/OFF Method

(Activation on threshold, with maintenance of the state)

2A1 **SetPoint**: value to maintain into the process

2A2 **Activation Type**: **Low** as the minimum value to maintain
High as the maximum value to maintain

2A3 **Hysteresis**: Incremental or decremental value of the SetPoint

2A4 **Hysteresis Time**: Time activated on the hysteresis value

2A5 **Delay Start**: Delay time for relay activation

2A6 **Delay End**: Delay time for relay deactivation

2A7 **OFA**: Relay maximum activation time

2A8 **Over Range**: A value that is subtracted from and added to the SetPoint value and defines a measuring range of operation, outside of which the measure error message is displayed.

2A9 **Permanence**: Control on the variation of measure

2A9A: **Status**: Enables or disables the function

2A9B: **Interval**: A value that is subtracted from and added to the value

2A9C: **Time**: Maximum permanence time of the measure



Note: See **ANNEX A** for a graphical example on using

Timed Method

(Timed activation on threshold)

We have all the items described in the ON/OFF method.

In addition we have:

2A10 **Time On**: Relay closing time

2A11 **Time Off**: Wait time with the relay open



Note: See **ANNEX B** for a graphical example on using

Proportional (PWM) Method

(Timed activation on proportional threshold)

We have all the items described in the ON/OFF method.

In addition we have:

2A10 **Period**: Maximum time to modulate according to the measure

2A11 **Proportional Band**: A value that is subtracted from or added to the SetPoint value, within the range the instrument calculates the relay closing time proportional to the measure according to the distance from the SetPoint.



Note: See **ANNEX C** for a graphical example on using

2 SETUP	
▶ A:	Relay 1 Disabled
B:	Relay 2 Disabled
C:	SSR 1 Disabled
D:	SSR 2 Disabled
E:	Output mA1 Disabled

01/06

2A RELAY_1_ON/OFF	
▶ 1:	SetPoint 1.20 ppm
2:	Activ. Type High
3:	Hysteresis 0.00 ppm
4:	Hyst. Time 00' 00"
5:	Delay Start 00' 00"
6:	Delay End 00' 00"
7:	OFA OFF
8:	Over Range OFF
9:	Permanence OFF

01/09

2A RELAY_1_Timed	
7:	OFA OFF
8:	Over Range OFF
9:	Permanence OFF
▶ 10:	Time On 00' 10"
11:	Time Off 00' 10"

01/11

2A RELAY_1_PWM	
7:	OFA OFF
8:	Over Range OFF
9:	Permanence OFF
▶ 10:	Interval 00' 10"
11:	Prop. Band 0.20 ppm

01/11

SETUP MENU \RELAY 2 (TWO) (INDEX MENU 2B)

Scroll through the menu using the **(+)** or **(-)** key, select the item Relay 2 and confirm with the **Enter** key.

Scroll through the menu using the **(+)** or **(-)** key, select the item and confirm with the **Enter** key.

Relay 2 (two) can be set for the mA Measure or Temperature as indicated in the relay 1 menu (see the previous page), it is also possible to set the Wash and Alarm mode as follows:

Wash Method

Activation of a washing system for the probe

2B1 **Wash Time**: Value in minutes and seconds for washing the probe.

2B2 **Delay Measure**: Value in minutes and seconds to wait for the stability of measure.

2B3 **Wait New Wash**: Value in hours and minutes of waiting for a new washing action.



Note: See **ANNEX D** for a graphical example on using

Alarm Method

Remote repetition of the alarm through relay 2 (two). below is the list of the alarm events:

2B1 Over Range R1: measure out of range Relay 1

2B2 OFA R1: Maximum dosing time expired

2B3 Permanence Measure: measure blocked (frozen)

2B4 Reed Alarm: Alarm for the Reed sensor activation

2B5 Hold Alarm: Alarm for the Hold signal activation

2B6 Temperature Probe Alarm: Alarm for probe disconnected



Note: See **ANNEX E** for a graphical example on using

2 SETUP	
A: Relay 1	Disabled
▶ B: Relay 2	Disabled
C: SSR 1	Disabled
D: SSR 2	Disabled
E: Output mA1	Disabled
01/06	

2B Relay 2 Wash	
▶ 1: Wash Time	00' 00"
2: Delay Meas.	00' 00"
3: Wait New	OFF
01/3	

2B Relay 2 Alarms	
▶ 1: OverRange R1	NO
2: OFA R1	NO
3: Perm. Meas.R1	NO
4: Alarm Reed	NO
5: Alarm Hold	NO
6: Alarm Probe	NO
01/06	

SETUP MENU SSR1 AND SSR2 (INDEX MENU 2C AND 2D)

Scroll through the menu using the **(+)** or **(-)** key, select the item SSR1 and 2 and confirm with the **Enter** key.

Scroll through the menu using the **(+)** or **(-)** key, select the item and confirm with the **Enter** key.

The outputs SSR1 (one) and SSR2 (two) are two solid state relays used as frequency outputs.

The outputs SSR1 and SSR2 can be set either for mA Measure or for Temperature Measure

SSR1 Setup (INDEX MENU 2C)

2C1 **SetPoint**: value to maintain into the process

2C2 **Activation Type**:

Low as the minimum value to maintain

High as the maximum value to maintain

2C3 **Pulse Max**: Maximum value of pulses (range:20÷400)

2C4 **Pulse min**: Minimum value of pulses (range:1÷100)

2C5 **Proportional Band**: A value that is subtracted from or added to the SetPoint value, within the range the instrument calculates the number of pulses proportional to the measure according to the distance from the SetPoint.

2 SETUP	
A: Relay 1	Disabled
B: Relay 2	Disabled
▶ C: SSR 1	Disabled
D: SSR 2	Disabled
E: Output mA1	Disabled
01/06	

2C SSR1	
▶ 1: SetPoint	1.20 ppm
2: Activ. Type	High
3: Pulse Max	400
4: Pulse min	1
5: Prop. Band	0.20 ppm
01/05	



Note: See ANNEX F for a graphical example on using

SSR2 Setup (INDEX MENU 2D)

2D1 **SetPoint**: value to maintain into the process

2D2 **Activation Type**:

Low as the minimum value to maintain

High as the maximum value to maintain

2D3 **Pulse Max**: Maximum value of pulses (range:20÷400)

2D4 **Pulse min**: Minimum value of pulses (range:1÷100)

2D5 **Proportional Band**: A value that is subtracted from or added to the SetPoint value, within the range the instrument calculates the number of pulses proportional to the measure according to the distance from the SetPoint.

2D SSR2	
▶ 1: SetPoint	25.0°C
2: Activ. Type	High
3: Pulse Max	400
4: Pulse min	1
5: Prop. Band	10.0°C
01/05	



Note: See ANNEX F for a graphical example on using

SETUP MENU \ OUTPUT MA1 AND MA2 (INDEX MENU 2E AND 2F)

Scroll through the menu using the **(+)** or **(-)** key, select the item mA1 and 2 and confirm with the **Enter** key.

Scroll through the menu using the **(+)** or **(-)** key, select the item and confirm with the **Enter** key

The outputs mA1 (one) and mA2 (two) are two current outputs in mA (milliAmpere), in active configuration with the range 4÷20 mA.

The **Outputs mA1** and **mA2** can be set either for mA Measure or for Temperature Measure.

Output mA1 Setup (INDEX MENU 2E)

- 2E1 **Start mA**: Measure value associated to the 4 mA value
- 2E2 **End mA**: Measure value associated to the 20 mA value
- 2E3 **Keep**: Freezes the current value in case of Holding Alarm
- 2E4 **Namur**: Sets the current value to 3.6 mA or 22 mA in case of Alarm



Note: See **ANNEX G** for a graphical example on using

Output mA2 Setup (INDEX MENU 2F)

- 2F1 **Start mA**: Measure value associated to the 4 mA value
- 2F2 **End mA**: Measure value associated to the 20 mA value
- 2F3 **Keep**: Freezes the current value in case of Holding Alarm
- 2F4 **Namur**: Sets the current value to 3.6 mA or 22 mA in case of Alarm



Note: See **ANNEX G** for a graphical example on using

2 SETUP	
A: Relay 1	Disabled
B: Relay 2	Disabled
C: SSR 1	Disabled
D: SSR 2	Disabled
▶ E: Output mA1	Disabled
F: Output mA2	Disabled

2E Output mA1	
▶ 1: Start mA	0.00 ppm
2: End mA	5.00 ppm
3: Keep	NO
4: Namur	OFF
01/04	

2F Output mA2	
▶ 1: Start mA	-50.0°C
2: End mA	150.0°C
3: Keep	NO
4: Namur	OFF
01/04	

ADVANCED MENU (INDEX MENU 3)

Use the **MODE** key to scroll through the icons on the status bar, from left to right, select the **adv** menu and confirm with the **Enter** key.

The **Advanced** menu consists of fourteen (14) items or sub-menus, as follows:

- A: Language
- B: Password
- C: Display
- D: Measure
- E: Measure Range
- F: Temperature Measure
- G: Alarms Setting
- H: Outputs Setting
- I: RS485 Setting
- L: USB Setting
- M: Control Panel
- N: Statistics
- O: System Reset
- P: Firmware Revision

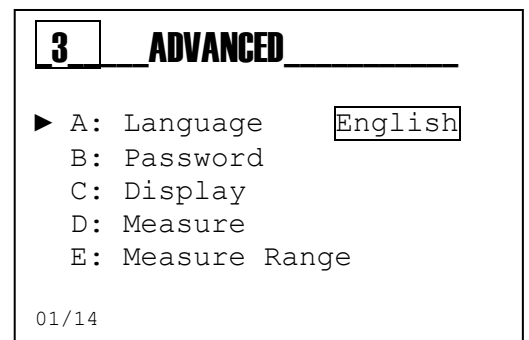
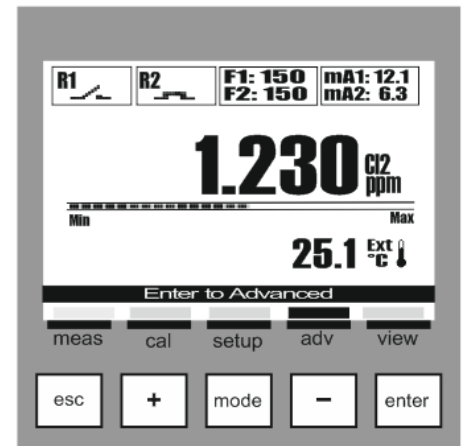

Below are illustrated the settings required for each sub-menu indicated above.

To exit the menu, press the **Esc** key; when the parameters have been changed, the instrument will display the question "save?"; confirm with the **Enter** key.



For not saving, select NO using the (+) or (-) key and confirm with the **Enter** key.

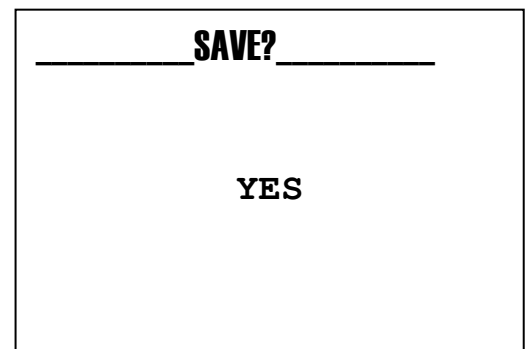

ADVANCED MENU \ LANGUAGE (INDEX MENU 3A)

The menu consists of five (5) items that allow to select the dialog language for the instrument's menus and messages.

Scroll through the menu using the **(+)** or **(-)** key, select the item Language and confirm with the **Enter** key.

Scroll through the menu using the **(+)** or **(-)** key, select the item and confirm with the **Enter** key.

The instrument automatically changes the language of the menu and returns to the previous level, menu 3.

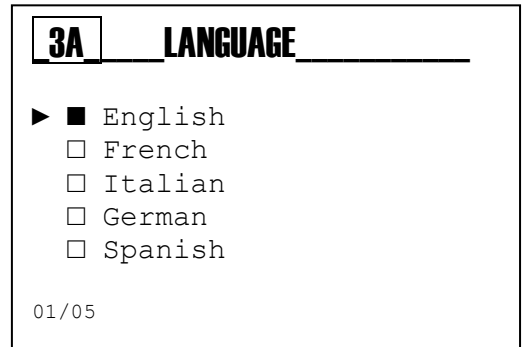
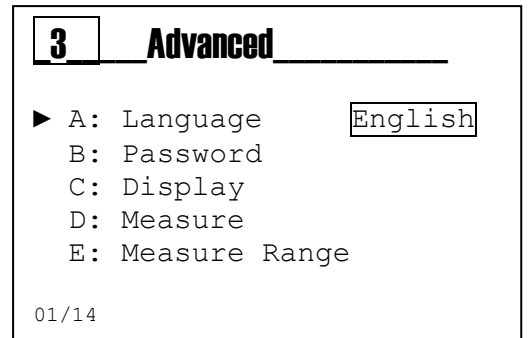

ADVANCED MENU \ PASSWORD (INDEX MENU 3B)

The menu consists of three (3) items that allows to select the menu protection Password and enable the Calibration menu or the Setup menu.

Scroll through the menu using the **(+)** or **(-)** key, select the item and confirm with the **Enter** key.

Password Function

3B1 Set Password: set the numeric value

Note: If the password is present it will be displayed

Example: "Old Password 1234"

3B2 Calibration Menu: Enable or Disable the Calibration menu

3B3 Setup Menu: Enable or Disable the Setup menu

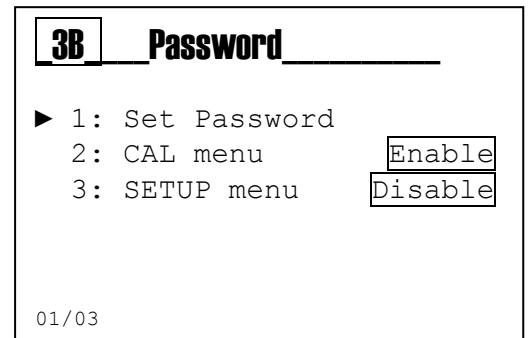
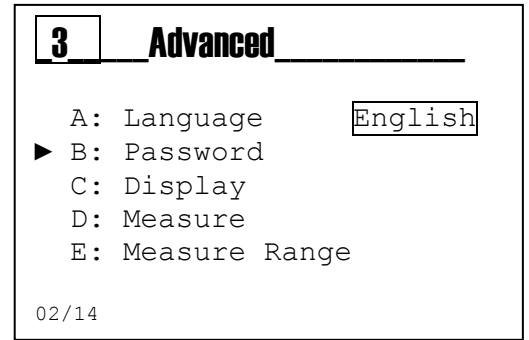

Note: To remove the password set four zeros (0000) and confirm with the **Enter** key.

The following are examples of the sub-menus shown above.



Menu 3B1

Set the value for password, other than 0000 using **(+)** and **(-)** keys and move to the right using the **Mode** key.



Menu 3B2

YES= Menu Enabled

NO= Menu Disabled; can be accessed by entering the password

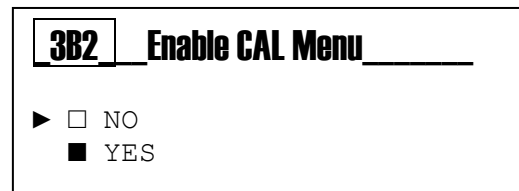

Menu 3B3

YES= Menu Enabled

NO= Menu Disabled; can be accessed by entering the password

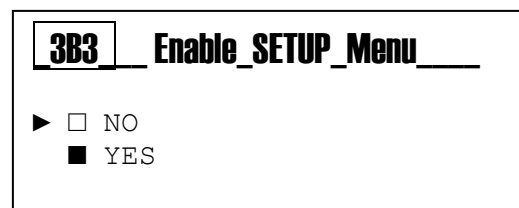

ADVANCED MENU \ DISPLAY (INDEX MENU 3C)

The menu consists of five (5) items that allow to select Contrast, Mode, Mode ON, Mode ECO, Reverse.

Scroll through the menu using the **(+)** or **(-)** key, select the item and confirm with the **Enter** key.

Display Function:

3C1 Contrast: Balance value between the menu writings and the background brightness

3C2 Mode: Turned on, Turned off, "ECO" Adjustment

3C3 On: Light value function always on

3C4 ECO: Light value function of electronic regulation

3C5 Reverse: Inverted display, white writings on black background.

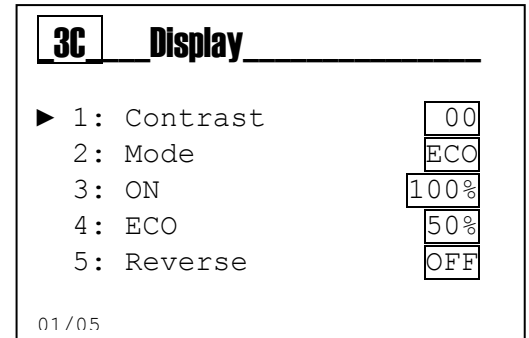
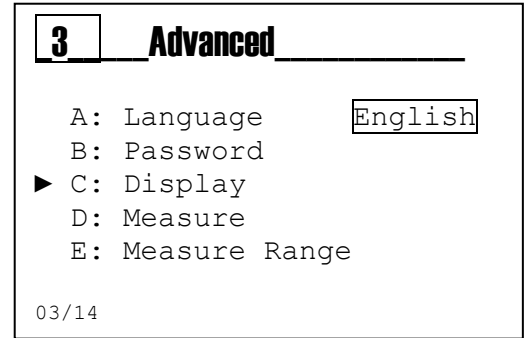

The following are examples of the sub-menus shown above.

Menu 3C1

Adjusts the background brightness

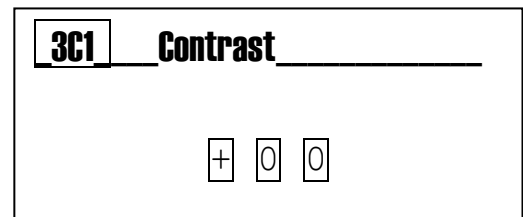

Menu 3C2

Select the Backlight function:

OFF= Turned off; ON= Turned on; ECO= Fade

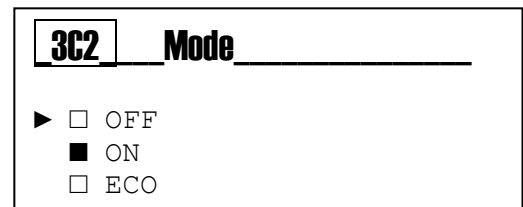

Menu 3C3

Select the brightness value for ON mode

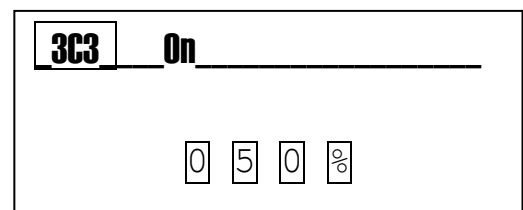

Menu 3C4

Select the brightness value for ECO mode

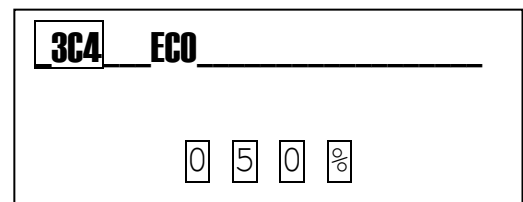

Menu 3C5

Invert the writings on the display to obtain a high contrast



DosingPump.ir

ADVANCED MENU \ MEASURE (INDEX MENU 3D)

The menu consists of six (6) items that allow to select Measure.

Scroll through the menu using the **(+)** or **(-)** key, select the item and confirm with the **Enter** key.

Measure Function (Index menu 3D)

3D1 **Measure Unit:** Select the measure unit.

3D2 **Custom Unit:** Possibility to write any custom measure unit. Maximum 4 characters/symbols.

Note: This measure unit will be displayed only if the menu 3D1 is set as "Custom".

3D3 **Measure Name:** Select the measure name.

3D4 **Custom Name:** Possibility to write any custom name to match the measure. Maximum 4 characters/symbols.

Note: This name will be displayed only if the menu 3D3 is set as "Custom".

3D5 **Measure Filter:** The measure is filtered with arithmetic mean.

- Low= arithmetic mean every 4 seconds
- Medium= arithmetic mean every 8 seconds
- High= arithmetic mean every 16 seconds

3D6 **Decimal Point:** set the position of the decimal point for the measure.

The following are examples of the sub-menus shown above.

Menu 3D1

Select the measure unit. By selecting "Custom" the measure unit is displayed as set in the menu 3D2.

Menu 3D2

Possibility to write the custom measure unit, max. 4 characters.

3	Advanced	
A:	Language	English
B:	Password	
C:	Display	
▶ D:	Measure	
E:	Measure Range	
04/14		

3D	Measure	
▶ 1:	Meas. Unit	ppm
2:	Unit.Custom	
3:	Meas. Name	C12
4:	Name Custom	
5:	Filter	Medio
6:	Dec. Point	XXX,XX

3D1	Measure_Unit
▶	<input checked="" type="checkbox"/> ppm
	<input type="checkbox"/> ppb
	<input type="checkbox"/> mg/l
	<input type="checkbox"/> mA
	<input type="checkbox"/> Custom
01/05	

3D2	Custom_Unit
U n i t	

Menu 3D3

Select the measure name. By selecting “Custom” the measure name is displayed as set in the menu 3D4.

3D3 Measure_Name

- ▶ c12
- PAA
- H2O2
- O3
- Custom

01/05

Menu 3D4

Possibility to write the custom measure name, max. 4 characters.

3D4 Custom_Name

N a m e

Menu 3D5

The measure is filtered with arithmetic mean.

- Low= arithmetic mean every 4 seconds
- Medium= arithmetic mean every 8 seconds
- High= arithmetic mean every 16 seconds

3D5 Meas. Filter

- ▶ Low
- Medium
- High

01/03

Menu 3D6

Set the position of the decimal point for the measure to highlight the decimal value.

Scroll through the menu using the (+) or (-) key, select the item and confirm with the **Enter** key.

3D6 Decimal_Point

- ▶ XXXXX,
- XXXX,X
- XXX,XX
- XX,XXX
- X,XXXX

01/05

ADVANCED MENU \ MEASURE RANGE (INDEX MENU 3E)

The menu consists of five (5) items that allow to select Measure.

Scroll through the menu using the **(+)** or **(-)** key, select the item and confirm with the **Enter** key.

Measure Range Function (Index menu 3E)

3E1 **Sensor Type:** Select the type of sensor used, 0/20mA or 4/20mA.

3E2 **Min Range:** Set the value corresponding to 0 mA or 4 mA. Value between -99999 and 99999.

3E3 **Max Range:** Set the value corresponding to 20 mA. Value between -99999 and 99999.

3E4 Over Range:

- OFF: Over Range Alarm disabled.
- 22mA: If the input current to the instrument is higher than 22mA, the Over range alarm is activated.

3E5 Under Range:

- OFF: Over Range Alarm disabled.
- 3.6mA: If the input current to the instrument is lower than 3.6mA, the Under range alarm is activated.

The following are examples of the sub-menus shown above.

Menu 3E1

Select the type of sensor used, 0/20mA or 4/20mA.

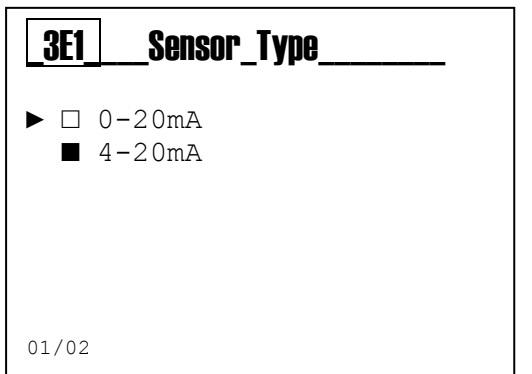
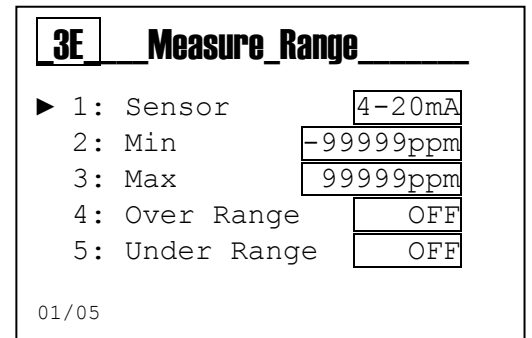
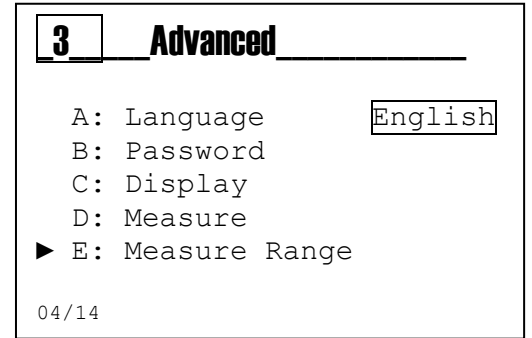

Menu 3E2

Set the value corresponding to 0 mA or 4 mA. Value between -99999 and 99999.

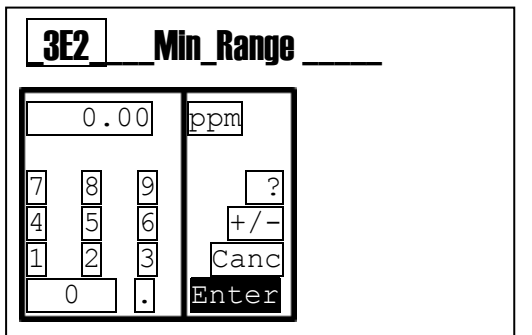

Menu 3E3

Set the value corresponding to 20 mA.
Value between -99999 and 99999.

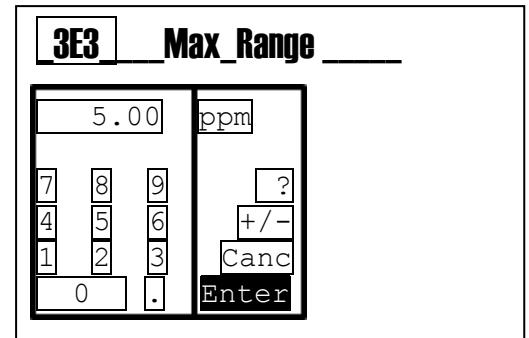

Menu 3E4

Set the Over Range Alarm.

- OFF: Over Range Alarm disabled.
- 22mA: If the input current to the instrument is higher than 22mA, the Over range alarm is activated.

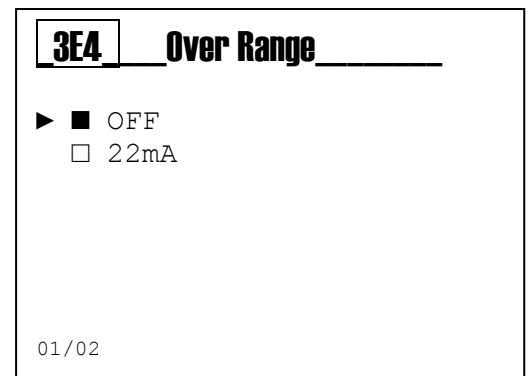

Menu 3E5

Set the Under Range Alarm.

- OFF: Under Range Alarm disabled.
- 3.6mA: If the input current to the instrument is lower than 3.6mA, the Under range alarm is activated.



Note: The Under Range Alarm can only be activated if the menu 3E1 is set as 4-20mA. If the menu 3E1 is set as 0-20mA, the Under Range menu is configured to OFF and cannot be changed.

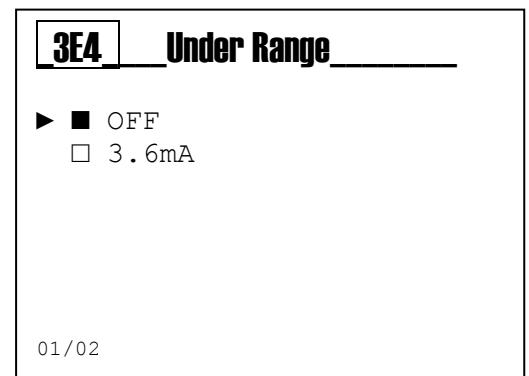

ADVANCED MENU \ TEMPERATURE MEASURE (INDEX MENU 3F)

Scroll through the menu using the **(+)** or **(-)** key, select the item and confirm with the **Enter** key.

Temperature Measure Function (INDEX MENU 3F)

3F1 Selection: PT100 or PT1000 temperature sensor connected or using a manual temperature value.

3F2 Measure Unit: Set Celsius (°C) or Fahrenheit (°F) unit

3F3 Manual Value: Set the temperature value without PT100 or PT1000 temperature sensor.

3F4 Filter: The measure is filtered with arithmetic mean.

- Low= arithmetic mean every 4 seconds
- Medium= arithmetic mean every 8 seconds
- High= arithmetic mean every 16 seconds

3
Advanced

B: Password

C: Display

D: Measure

E: Measure Range

▶ F: Temperature Measure

06/14

3F
Temperature_Measure

▶ 1: Selection Manual

2: Measure Unit °C

3: Manual Value 25°C

4: Filter Medium

01/04

The following are examples of the sub-menus shown above.

Menu 3F1

Select between manual temperature value function and external temperature measure through PT100 or PT1000 temperature sensor.

3F1
Temp._Meas._Enabled

▶ Manual

External

01/02

Menu 3F2

Select the measure unit.

3F2
Temp._Meas._Unit

▶ °C

°F

01/02

Menu 3F3

Set the temperature value as manual value.

3F3
T_Manual_Value

27.0

°C

7

4

1

0

8

5

2

.

9

6

3

?

+/-

Canc

Enter

Menu 3F4

The measure is filtered with arithmetic mean.

- Low= arithmetic mean every 4 seconds
- Medium= arithmetic mean every 8 seconds
- High= arithmetic mean every 16 seconds

3F4
T_Measure_Filter

▶ Low

Medium

High

01/03

ADVANCED MENU \ ALARMS SETTING (INDEX MENU 3G)

Scroll through the menu using the **(+)** or **(-)** key, select the item and confirm with the **Enter** key.

Alarms Setting Function

3G1 Reed Logic: Set the sensor logic

- Reed NO (Normally Open)
- Reed NC (Normally Close)

3G2 Delay Reed: Set the delay time for alarm activation to change REED status

3G3 Delay Hold: Set the delay time for alarm activation for HOLD signal presence

3G4 Power Supply Interruption: Enables a visual alarm in case a power supply interruption took place in precedence.

3G5 Instrument blocking: Enables instrument blocking in case of alarm. The outputs are automatically set on the programmed alarm state.

3G6 Alarm Temp.: Enables a visual alarm or a instrument block in case the temperature probe is broken or disconnected.

3G7 Service: Set a value in days to display a message of "Service Required".

3	Advanced
C:	Display
D:	Measure
E:	Measure Range
F:	Temperature Measure
▶ G:	Alarms Setting
07/14	

3G	Alarms_Setting	
▶ 1:	Reed Logic	NO
2:	Delay Reed	00'00"
3:	Delay Hold	00'00"
4:	Switch OFF	NO
5:	Block	No
6:	Alarm Temp.	Notif.
7:	Service	OFF
01/07		

ADVANCED MENU \ OUTPUTS SETTING (INDEX MENU 3H)

Scroll through the menu using the **(+)** or **(-)** key, select the item and confirm with the **Enter** key.

Outputs Setting Function

3H1 Relay 1: Disabled, On/OFF (threshold), Timed, Proportional PWM, either for Measure or for Temperature Measure

3H2 Relay 2: Disabled, On/OFF (threshold), Timed, Proportional PWM, either for Measure or for Temperature Measure, and also Probe Wash, Remote Alarm

3H3 SSR 1: Disabled, Measure, Temperature Measure

3H4 SSR 2: Disabled, Measure, Temperature Measure

3H5 mA 1: Disabled, Measure, Temperature Measure

3H6 mA 2: Disabled, Measure, Temperature Measure

3 Advanced

D: Measure
 E: Measure Range
 F: Temperature Measure
 G: Alarms Setting
 ▶ H: Outputs Setting

08/14

3H Outputs Setting

▶ 1: Relay 1 Disabled
 2: Relay 2 Disabled
 3: SSR 1 Disabled
 4: SSR 2 Disabled
 5: mA 1 Disabled
 6: mA 2 Disabled

01/06



Note: On the Setup menu (INDEX MENU 2) it is possible to set the parameters for each selected function.

3H1 Relay_1

▶ Disabled
 On/OFF Measure
 Timed Measure
 PWM Measure
 On/OFF Temp.
 Timed Temp.
 PWM Temp.

01/07

3H2 Relay_2

▶ Disabled
 On/OFF Measure
 Timed Measure
 PWM Measure
 On/OFF Temp.
 Timed Temp.
 PWM Temp.
 Probe Wash
 Alarm

01/09

3H3 SSR_1

▶ Disabled
 Measure
 Temperature

01/03

3H4 SSR_2

▶ Disabled
 Measure
 Temperature

01/03

3H5 mA_1

▶ Disabled
 Measure
 Temperature

01/03

3H6 mA_2

▶ Disabled
 Measure
 Temperature

01/03

DosingPump.ir

ADVANCED MENU \ RS485 PORT SETTING (INDEX MENU 3I)

Scroll through the menu using the **(+)** or **(-)** key, select the item and confirm with the **Enter** key.

RS485 Serial Port Setting Function:

- 311 RS485:** Enables the serial port (Enable/Disable)
- 312 Mode:** Standard protocol used (RTU/Ascii)
- 313 Address:** Communication Address (ID 1÷247)
- 314 Baud rate:** Communication speed (1200÷115200 bps)
- 315 Parity:** Parity bit for checking transmission (none, odd, even)
- 316 Bit stop:** Stop bits to set waiting time (1, 2)



Note: The RS485 function on the standard code is not available.

Note: the communication always takes place (RTU/ASCII) with 8 data bits

- The minimum polling time is set to 200ms.
- The accepted commands are:
 - a) Report Slave ID
 - b) Write Multiple Registers (max 4 registers per interrogation)
 - c) Read Holding Registers (max 4 registers per interrogation)
- The system always responds to these commands.
- If you are not in View Level mode or in RS485 Control Panel, cases in which you receive in response an error code and the command is not executed.
- Each writing operation which occurs in the registers with positive results, writes on the specific register a certain value.

To save on the memory of the instrument the value written into the register you must execute a write memory command realized with a Write Multiple Registers operation (amount of data to be written 1) at the address of the command register (4000), with parameter 2.

Alternatively, if you exit the programming, the system itself will ask you to save the changes you made to the parameters in memory because the system automatically reveals that the parameters in memory have been modified and it proposes to save them.

If the instrument is turned off WITHOUT having saved the written registers, the system will restart with the values previously set in memory.

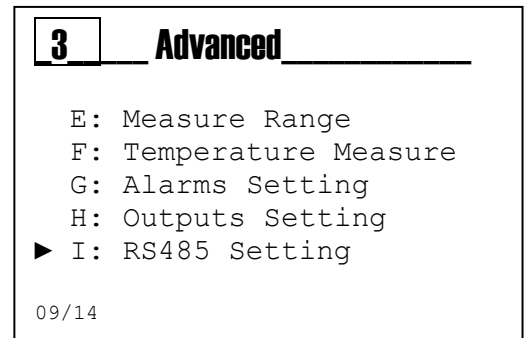

Example:

Relay 1 set as "ON/OFF Measure".

Setpoint to be set [index 2A1]: 950,52ppm

Conversion Decimal → Hexadecimal:

95052 → 0x1734C

Number of decimals for Setpoint: 2

Below are the values to be written in the registers related to Setpoint RL1 [index menu 2A1]:

Address 3100: 0x734C (Setpoint L)

Address 3101: 0x0001 (Setpoint H)

Address 3102: 0x0002 (Decimal Setpoint)

Write Multiple Registers command

Addr	Func	Start Addr H	Start Addr L	Data Word H	Data Word L	Data Byte Count	Data 3100 H	Data 3100 L	Data 3101 H	Data 3101 L	Data 3102 H	Data 3102 L	CRC H	CRC L
0x01	0x10	0x0C	0x1C	0x00	0x03	0x06	0x73	0x4C	0x00	0x01	0x00	0x02	0xD2	0xB6

To complete the writing operation of the Setpoint RL1 into the EEPROM of the instrument, run the following command:

Address 4000: 0x02 (Write to Eeprom)*

Write Multiple Registers command

Addr	Func	Start Addr H	Start Addr L	Data Word H	Data Word L	Data Byte Count	Data 4000 H	Data 4000 L	CRC H	CRC L
0x01	0x10	0x0F	0xA0	0x00	0x01	0x02	0x00	0x02	0xC0	0x31

* In case of setting more parameters, it is recommended to run the command 4000 only once after the set parameters.

To read the Setpoint RL1, run the following command:

Read Holding Registers command

Addr	Func	Start Addr H	Start Addr L	Data Word H	Data Word L	CRC H	CRC L
0x01	0x03	0x0C	0x1C	0x00	0x03	0xC7	0x5D

The read Setpoint will be formatted as follows:

Address 3100: 0x734C (Setpoint L)

Address 3101: 0x0001 (Setpoint H)

Address 3102: 0x0002 (Decimal Setpoint)

Reconstructing the data we will have the following value: 950,52ppm

To verify the set data, check the menu item Setpoint RL1 to the index 2A1.

DosingPump.ir

ADVANCED MENU \ USB PORT SETTING (INDEX MENU 3L)

The function is intended for internal use, to test and verify the instrument

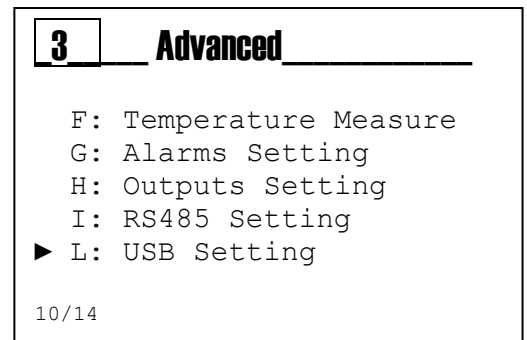

ADVANCED MENU \ CONTROL PANEL (INDEX MENU 3M)

Menu 3M Control Panel

Scroll through the menu using the (+) or (-) key, select the item and confirm with the **Enter** key.

- 3M1** Measure: Displays the unfiltered measure in μA .
- 3M2** Temp. Measure: Displays the unfiltered measure in $^{\circ}\text{C}/^{\circ}\text{F}$
- 3M3** Sim. Relay 1: Manual closing of the relay contact
- 3M4** Sim. Relay 2: Manual closing of the relay contact
- 3M5** Simulation Frequency 1: Simulates an output value
- 3M6** Simulation Frequency 2: Simulates an output value
- 3M7** Simulation Current Output 1: Simulates an output value
- 3M8** Simulation Current Output 2: Simulates an output value
- 3M9** Reed Input: Displays the Reed Input status
- 3M10** Hold Input: Displays the Hold Input status
- 3M11** View the sent and received Modbus frames.

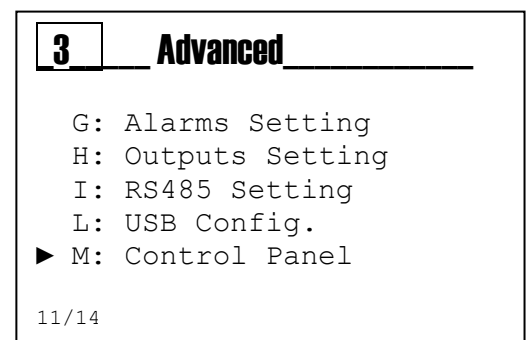

Note: The instrument allows the simultaneously simulation of multiple outputs, all the set values will be cleared on exiting the menu **3M Control Panel**.

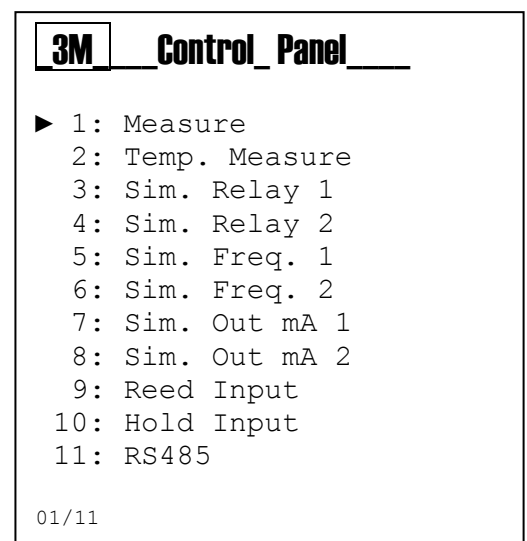

ADVANCED MENU \ STATISTICS (INDEX MENU 3N)

Menu 3N Statistics

Scroll through the menu using the **(+)** or **(-)** key, select the item and confirm with the **Enter** key.

- 3N1** Number of registered Power On
- 3N2** Number of registered Alarms
- 3N3** Number of activations Relay 1
- 3N4** Number of activations Relay 2
- 3N5** Number of activations Reed
- 3N6** Number of activations Hold
- 3N7** Reset all values recorded in the statistics menu

3 **Advanced**

H: Outputs Setting
I: RS485 Setting
L: USB Setting
M: Control Panel
▶ N: Statistics

12/14

3N **Statistics**

▶ 1: Power On n.
2: Alarms n.
3: Relay 1 Act.n.
4: Relay 2 Act.n.
5: Reed Act. n.
6: Hold Act. n.
7: Reset Statistics

01/07

ADVANCED MENU \ SYSTEM RESET (INDEX MENU 30)



Menu 30 Reset Instrument

The instrument allows to delete all the parameters and restore the default values.

3 Advanced

- I: RS485 Setting
- L: USB Setting
- M: Control Panel
- N: Statistics
- ▶ O: System Reset

13/14

30 System_Reset

Are you sure?

NO
YES

ADVANCED MENU \ FIRMWARE REVISION (INDEX MENU 3P)

Menu 3P Firmware Revision

The instrument displays the Firmware code and revision of the device.

3 Advanced

- L: USB Setting
- M: Control Panel
- N: Statistics
- O: Reset Instrument
- ▶ P: Firmware Revision

14/14

3P Firmware_Revision

Firmware Code
0000529XXX

Firmware Revision
X.X

VIEW MENU (INDEX MENU 4)

Use the **MODE** key to scroll through the icons on the status bar, from left to right, select the **view** menu and confirm with the **Enter** key.

The **Preview Menu** consists of 6 views

Scroll through the menu using the **(+)** or **(-)** key, select the item and confirm with the **Enter** key.

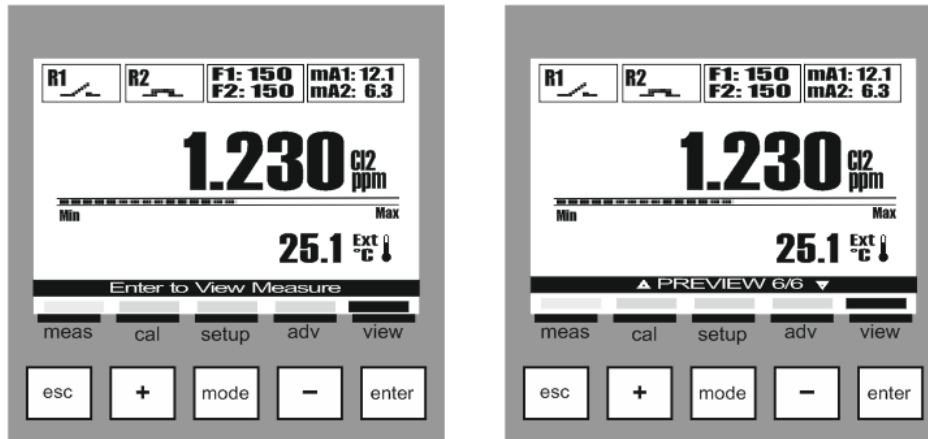

Views Table

<p>Preview 1/6 Standard</p>	<p>Preview 2/6 Complete</p>	<p>Preview 3/6 Two Big Measures</p>
<p>Preview 4/6 One Big Measure</p>	<p>Preview 5/6 Analog</p>	<p>Preview 6/6 Outputs and Inputs Table</p>

DosingPump.ir

GENERAL SPECIFICATIONS

Specifications mA Input	
Sensor type	Sensor with two or three wires
Sensor power supply 4/20mA 2 wires	(*)18Vdc $\pm 5\%$, max 30mA
Short circuit protection	Active
Measure Range	from 0 to 20 mA or from 4 to 20 mA
Error Condition	OFF, 3.6 mA, 22 mA
Resolution	$\pm 1 \mu\text{A}$
Accuracy	$\pm 0,2 \%$
Isolation	Functional
Pt100/ Pt1000 Specifications	
Temperature Input	Pt100/Pt1000
Pt100/Pt1000 Detection	Automatic
Error Condition	Automatic detection of disconnected/damaged probe
Driving Current	1 mA
Temperature Measure Range	-50.0 to $150.0 \text{ }^\circ\text{C}$ (-58.0 to $302.0 \text{ }^\circ\text{F}$)
Sensor Maximum Distance	10 to 20 m (33 to 65 ft) depending on sensor
Temperature Resolution	0.1°C ($^\circ\text{F}$)
Temperature Accuracy	Pt100: $\pm 0.5^\circ\text{C}$ ($\pm 0.9 \text{ }^\circ\text{F}$) - Pt1000: $\pm 0.2^\circ\text{C}$ ($\pm 0.4 \text{ }^\circ\text{F}$)
Insulation	Functional

** DO NOT exceed the maximum allowable current limit, RISK of damaging the apparatus

MECHANICAL SPECIFICATIONS FOR VERSION 1/4DIN

Dimensions (chassis – A x L x P)*	92 x 92 x 57,3 mm
Front Bezel – (A x L)	96 x 96 mm
Max. Depth	42 mm
Weight	400 g (0,88 lb)
Material	ABS/polycarbonate
Protection	IP 65 (front)/IP 20 (chassis)
Relative Humidity	0 to 95% non-condensing

* L = Width, A = Height, P = Depth

MECHANICAL SPECIFICATIONS FOR VERSION 1/2DIN

Dimensions (chassis – A x L x P)*	144 x 144 x 122.5 mm
Front Bezel – (A x L)	144 x 144 mm
Weight	823 g (1.81 lb)
Material	ABS/polycarbonate
Protection	IP 65
Relative Humidity	0 to 100% condensing

* L = Width, A = Height, P = Depth

ENVIRONMENTAL SPECIFICATIONS FOR VERSION 1/2DIN & 1/4DIN

Storage Temperature	-25 to $65 \text{ }^\circ\text{C}$ (-13 to $149 \text{ }^\circ\text{F}$)
Environmental temperature range of operation	-10 to $50 \text{ }^\circ\text{C}$ (14 to $122 \text{ }^\circ\text{F}$)
Emissions	According to EN55011 Class A specifications

DosingPump.ir

ELECTRICAL SPECIFICATIONS

Power Supply (version 100÷240 VCA)	
Electrical requirements	from 100 to 240 VAC ±10%, 5 W
Frequency	50 to 60 Hz
Power Supply Fuse	500 mA delay not recoverable
Short Circuit Protection	Active
Power Supply (version 12÷32 VCC)	
Electrical requirements	from 12 to 32 VCC, or 24Vac ±10%, 3,5W
Power Supply Fuse	1 A delay not recoverable
Short Circuit Protection	Active
Reverse Polarity Protection	Active
Relay Outputs	
RL1 and RL2	2-SPST mechanical 250 VAC/5A, 30 VCC/3 A
Relay RL1 Configuration	Load Activation
Relay RL2 Configuration	Load Activation, Probe Wash, Alarm Repetition
Cycle time	1sec to 3600sec
Delay time	1sec to 3600sec
Test Mode	ON, OFF
SSR Outputs (Solid State Relays)	
SSR1 and SSR2	2-SPST 400 VAC, max 125 mA, Bidirectional, NPN, PNP
Resistance in ON State	26 ohm @ 50mA
Leakage Current in OFF State	200 nA max
SSR1 and SSR2 Configuration	Pulse output
Frequency Range	0 to 400 imp/min
Pulse Duration	100 msec
Test Mode	0 to 400 imp/min
Outputs 4÷20 mA	
Analog Output Signals	2 outputs 4÷20 mA, galvanically isolated from one another and from the power supply.
Measure Error	+/- 0,01 mA
Load	max. 800 Ω
Error Condition	NAMUR: OFF, 3.6 mA, 22 mA
Test Mode	3 to 23 mA
Digital Inputs	
FREQ1 Digital Input	(*) Input for external counter
DIR1 Digital Input	(*) Digital input direction for external counter
REED Digital Input	Input for dry contact 5 VCC, max 6 mA
HOLD Digital Input	Powered Input 12÷32 VCC, max 10 mA
Communication Ports	
USB Digital Communication Port	(*)USB Port, type B connector
RS485 Digital Communication Port	Optional (on request)
Output 5 Vdc	
Voltage	(**) 5 V CC ±2%, max. 20 mA
Short Circuit Protection	Active
User Interface	
Connection Terminals	Removable screw terminals AWG 14 < 2.5 mm ²
Machine Cycle Time	ca. 1 s
Keyboard	5 tactile feedback keys
Display	Graphic LCD 128x128 pixels, Transflective, Backlit
Display Refresh	500 msec
Backlight	White, Green and Red with energy saving function

* This function is currently not used

** DO NOT exceed the maximum allowable current limit, RISK of damaging the apparatus

DosingPump.ir

ANNEX A: ON/OFF RELAY SETUP

Below is an example of settings for the Relay 1 or 2 to adjust the Measure using the pulse/pause method (on/off).

Example:

2A RELAY_1_ON/OFF	
1: SetPoint	1.20ppm
2: Activ. Type	High
3: Hysteresis	0.00ppm
4: Hyst. Time	00'00"
5: Delay Start	00'00"
6: Delay End	00'00"
7: OFA	OFF
8: Over Range	0.50ppm
9: Permanence	OFF

01/09

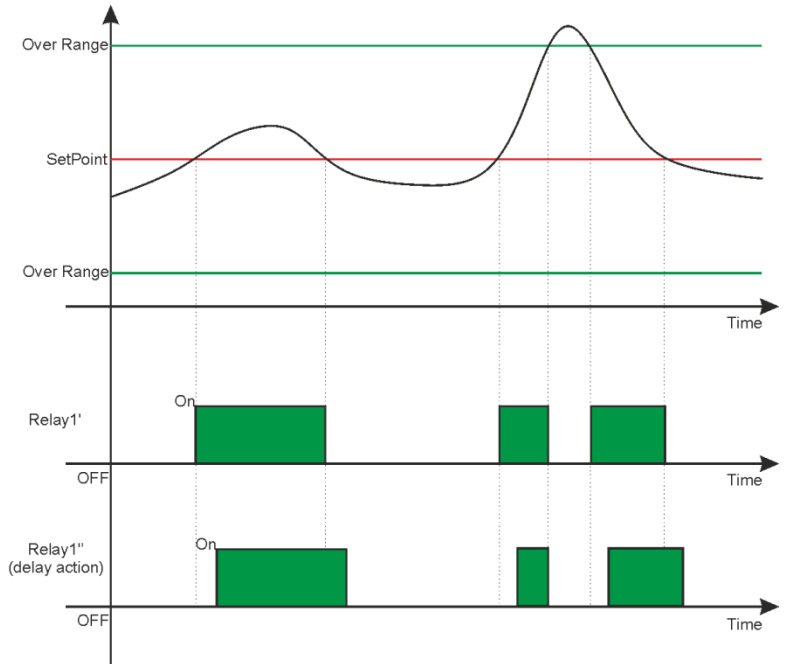

Note:



- **Relay Activation:** When the measure (black line) exceeds the SetPoint the relay is activated and this status is maintained until the measure decreases at the SetPoint value (see relay 1').
- **Delay Activation:** By setting the menu items "5" and "6" the relay activation will be delayed equal to the set time (see relay 1").
- **Measure out of range:** When the measure (black line) exceeds the maximum or minimum Over Range value (green line), the system displays a visual alarm and blocks the dosage by changing the status of the relay 1 or 2.

Low Function: By setting the menu item "2" with the variable Low the relays activations are inverted compared to the above diagram.

Hysteresis Function: By setting the menu items "3" and "4" the instrument maintains the relay activation status both for the measure value and for the time.

ANNEX A: ON/OFF RELAY SETUP WITH PERMANENCE TIME AND OFA FUNCTION.

Below is an example of settings for the Relay 1 or 2 to adjust the Measure using the pulse/pause method (on/off) with OFA timers and Permanence Measure.

2A RELAY_1_ON/OFF	
1: SetPoint	1.20ppm
2: Activ. Type	High
3: Hysteresis	0.00ppm
4: Hyst. Time	00'00"
5: Delay Start	00'00"
6: Delay End	00'00"
7: OFA	00h 10m
8: Over Range	0.50ppm
9: Permanence	On

01/09

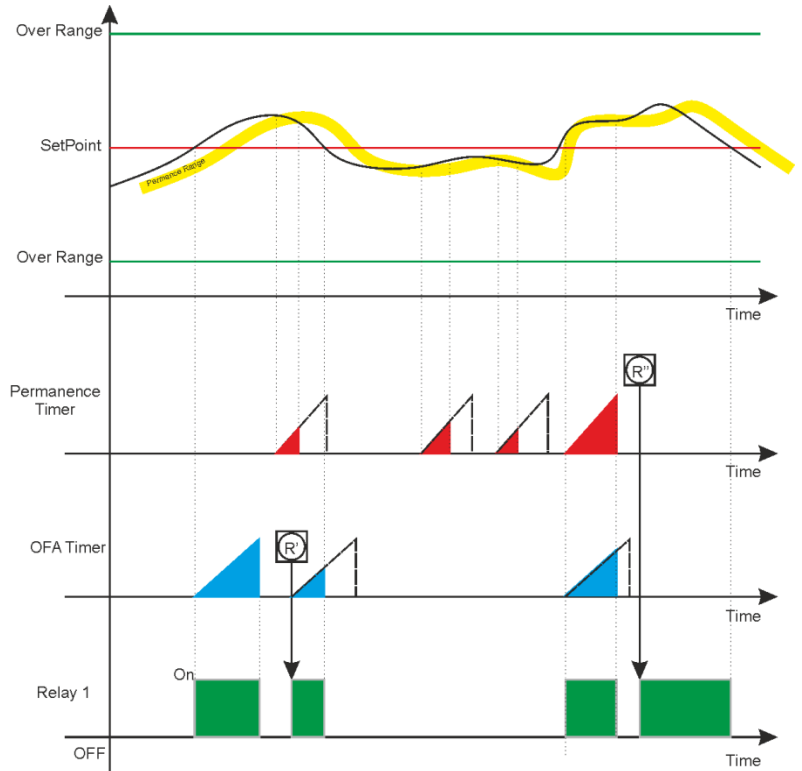

All the settings described on the previous page remain valid.

Note:



- OFA (Over Feed Alarm):** By setting the function “7” OFA with a time in hours and minutes a control timer is activated in parallel to the relay activation. The function checks the activated relay persistence times and generates a visual prealarm at 70% of set value and a blocking alarm (R') at the end of the set time (100%). A manual intervention will be required to remove the blocking with the reset of the OFA function on the alarms menu (see alarms section).
- Measure Permanence:** By setting the function “9” Permanence, represented on the graph with a yellow line, a function is activated to check the repetitive measure around the set interval. The measure persistence equal to the set time generates an alarm with instrument blocking; the permanence time (R”) is represented with the red color. A manual intervention will be required to remove the blocking with the reset of the Permanence function on the alarms menu (see alarms section).

ANNEX B: TIMED RELAY SETUP

Below is an example of settings for the Relay 1 or 2 to adjust the Measure using the timed method.

2A RELAY_1 Timed	
1: SetPoint	1.20ppm
2: Activ. Type	High
3: Hysteresis	0.00ppm
4: Hyst. Time	00' 00"
5: Delay Start	00' 00"
6: Delay End	00' 00"
7: OFA	OFF
8: Over Range	0.50ppm
9: Permanence	OFF
10: Time On	01' 00"
11: Time Off	01' 00"

01/11

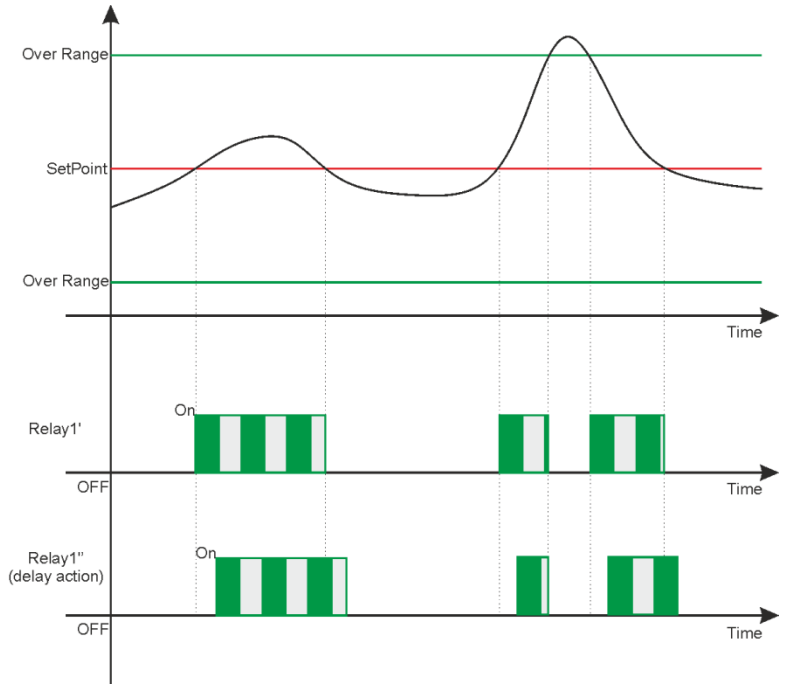

Note:



- **Relay Activation:** When the measure (black line) exceeds the SetPoint the relay is activated and the times On and Off are executed as set on the menu items "10" and "11"; this status is maintained until the measure decreases at the SetPoint value (see relay 1').
- **Delay Activation:** By setting the menu items "5" and "6" the relay activation will be delayed equal to the set time (see relay 1")
- **Measure out of range:** When the measure (black line) exceeds the maximum or minimum Over Range value (green line), the system displays a visual alarm and blocks the dosage by changing the status of the relay 1 or 2.

Low Function: By setting the menu item "2" with the variable Low the relays activations are inverted compared to the above diagram.

Hysteresis Function: By setting the menu items "3" and "4" the instrument maintains the relay activation status both for the measure value and for the time.

ANNEX B: TIMED RELAY SETUP WITH PERMANENCE TIME AND OFA FUNCTION.

Below is an example of settings for the Relay 1 or 2 to adjust the Measure using the timed method with OFA timers and Permanence Measure.

2A RELAY_1 Timed	
1: SetPoint	1.20ppm
2: Activ. Type	High
3: Hysteresis	0.00ppm
4: Hyst. Time	00' 00"
5: Delay Start	00' 00"
6: Delay End	00' 00"
7: OFA	OFF
8: Over Range	0.50ppm
9: Permanence	OFF
10: Time On	01' 00"
11: Time Off	01' 00"

01/11

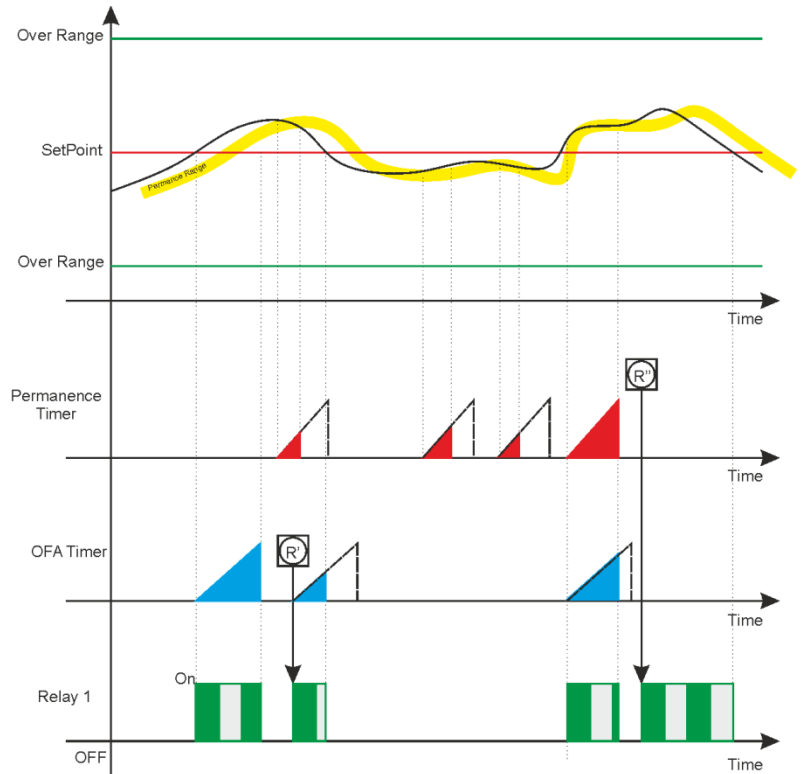

All the settings described on the previous page remain valid.

Note:



- OFA (Over Feed Alarm):** By setting the function “7” OFA with a time in hours and minutes a control timer is activated in parallel to the relay activation. The function checks the activated relay persistence times and generates a visual prealarm at 70% of set value and a blocking alarm (R') at the end of the set time (100%). A manual intervention will be required to remove the blocking with the reset of the OFA function on the alarms menu (see alarms section).
- Measure Permanence:** By setting the function “9” Permanence, represented on the graph with a yellow line, a function is activated to check the repetitive measure around the set interval. The measure persistence equal to the set time generates an alarm with instrument blocking; the permanence time (R”) is represented with the red color. A manual intervention will be required to remove the blocking with the reset of the Permanence function on the alarms menu (see alarms section).

ANNEX C: PROPORTIONAL (PWM) RELAY SETUP

Below is an example of settings for the Relay 1 or 2 to adjust the Measure using the proportional (PWM) method.

2A RELAY_1_PWM	
1: SetPoint	1.20ppm
2: Activ. Type	High
3: Hysteresis	0.00ppm
4: Hyst. Time	00' 00"
5: Delay Start	00' 00"
6: Delay End	00' 00"
7: OFA	OFF
8: Over Range	0.50ppm
9: Permanence	OFF
10: Interval	02' 00"
11: Prop. Band	0.25ppm

01/11

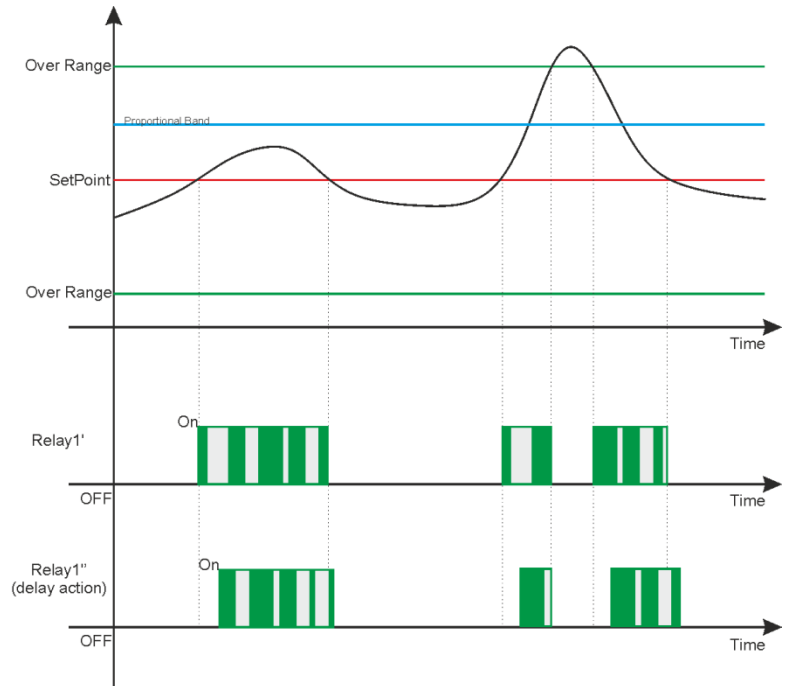

Note:



- **Relay Activation:** When the measure (black line) exceeds the SetPoint the relay is activated and the proportional times On and Off are executed as calculated in relation to the proportional band set in the menu items "10" and "11"; this status is maintained until the measure decreases at the SetPoint value (see relay 1').
- **Delay Activation:** By setting the menu items "5" and "6" the relay activation will be delayed equal to the set time (see relay 1'')
- **Measure out of range:** When the measure (black line) exceeds the maximum or minimum Over Range value (green line), the system displays a visual alarm and blocks the dosage by changing the status of the relay 1 or 2.

Low Function: By setting the menu item "2" with the variable Low the relays activations are inverted compared to the above diagram.

Hysteresis Function: By setting the menu items "3" and "4" the instrument maintains the relay activation status both for the measure value and for the time.

DosingPump.ir

ANNEX C: PROPORTIONAL (PWM) RELAY SETUP WITH PERMANENCE TIME AND OFA FUNCTION.

Below is an example of settings for the Relay 1 or 2 to adjust the Measure using the proportional (PWM) method with OFA timers and Permanence Measure.

2A RELAY_1_PWM	
1: SetPoint	1.20ppm
2: Activ. Type	High
3: Hysteresis	0.00ppm
4: Hyst. Time	00' 00"
5: Delay Start	00' 00"
6: Delay End	00' 00"
7: OFA	OFF
8: Over Range	0.50ppm
9: Permanence	OFF
10: Interval	02' 00"
11: Prop. Band	0.25ppm

01/11

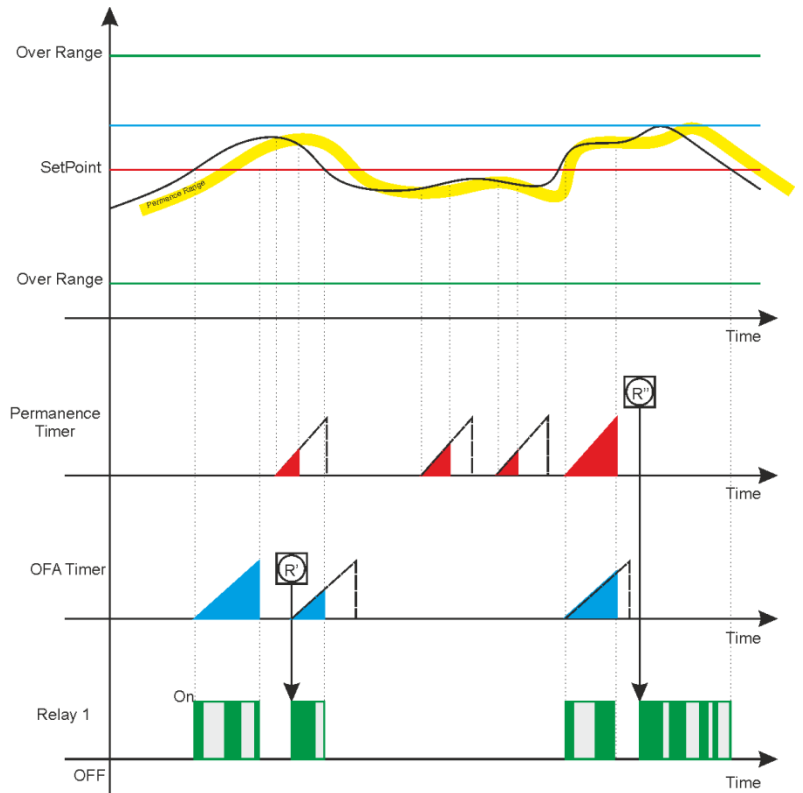

All the settings described on the previous page remain valid.

Note:



- OFA (Over Feed Alarm):** By setting the function "7" OFA with a time in hours and minutes a control timer is activated in parallel to the relay activation. The function checks the activated relay persistence times and generates a visual prealarm at 70% of set value and a blocking alarm (R') at the end of the set time (100%). A manual intervention will be required to remove the blocking with the reset of the OFA function on the alarms menu (see alarms section).
- Measure Permanence:** By setting the function "9" Permanence, represented on the graph with a yellow line, a function is activated to check the repetitive measure around the set interval. The measure persistence equal to the set time generates an alarm with instrument blocking; the permanence time (R") is represented with the red color. A manual intervention will be required to remove the blocking with the reset of the Permanence function on the alarms menu (see alarms section).

DosingPump.ir

ANNEX D: RELAY 2 SETUP FOR AUTOMATIC WASHING

Below is an example of settings for Relay 2 with Washing function to automate the probe cleaning with an external device(*).

2B Relay_2_Wash	
▶ 1: Wash Time	05' 00"
2: Delay Meas.	05' 00"
3: Wait New	06h 00m
01/03	

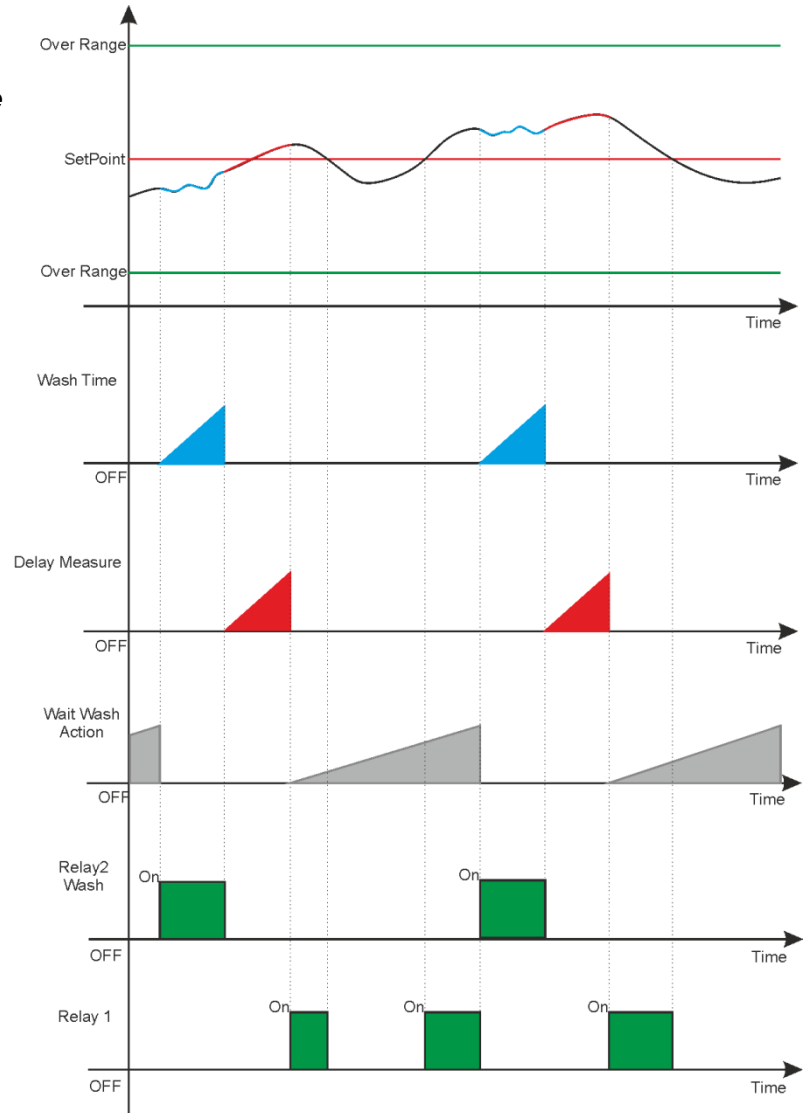

Note:



- **Wash Time:** Relay 2 is activated at the end of "Wait New Wash" timer and starts operating an external device to the set time. The instrument displays a service message by deleting the displayed measure and blocking all the instrument's functions (Amber color Backlight).
- **Delay Measure:** Relay 2 is turned off for the set time by displaying the measure and maintaining all the instrument's functions blocked (Amber color Backlight).
- **Wait New Wash:** The instrument counts the set time by performing the normal functions of measure and control; when the time expires, the "Wash Time" is activated.

(* The external washing system is not supplied with the instrument)

ANNEX E: RELAY 2 SETUP TO REPEAT REMOTE ALARM.

(*To set the Relay 2 for Remote Alarm see Advanced Setup Menu 3H)

On Setup Menu 2B it is possible to set the alarm conditions to be repeated by Relay 2; attention, check the Advanced Menu "3G" Alarms Configuration.

2B Alarm	
▶ 1: OverRange R1	NO
2: OFA R1	NO
3: Perm.Meas.R1	NO
4: Reed Alarm	NO
5: Hold Alarm	NO
6: Probe Alarm	NO

01/06

3G Alarms_Setting	
▶ 1: Reed Logic	NO
2: Delay Reed	00'00"
3: Delay Hold	00'00"
4: Switch OFF	NO
5: Instr. Blocking	NO
6: Alarm Temp.	Notif.
7: Service	OFF

01/07

Table with the alarm messages displayed by the instrument.

Number	Alarm	Message	Status
1	Not Present	No Item	
2	External Hold Input Active	Hold	Alarm with instrument blocking (*)
3	External Reed Input Active	Reed	Alarm with instrument blocking (*)
4	Temperature Sensor Broken or Disconnected	Alarm Fault Temp.	Alarm with instrument blocking (**)
5	5V Output in Short Circuit	Fault 5V	Visual alarm
6	Registered the absence of Power Supply	Switch OFF	Visual alarm
7	Service Timer Expired	Service	Visual alarm
8	Relay 1 Timer decreased at 70%	OFA1 R1	Preliminary Alarm
9	Relay 1 Timer decreased at 100%	OFA2 R1	Alarm with instrument blocking (*)
10	Measure outside of working range	Over Range R1	Alarm with instrument blocking (*)
11	Permanent measure to a fixed value	Holding R1	Alarm with instrument blocking (*)
12	Relay 2 Timer decreased at 70%	OFA1 R2	Preliminary Alarm
13	Relay 2 Timer decreased at 100%	OFA2 R2	Alarm with instrument blocking (*)
14	Measure outside of working range	OverRange R2	Alarm with instrument blocking (*)
15	Permanent measure to a fixed value	Holding R2	Alarm with instrument blocking (*)
16	Output 18V in short	Fault Vout mA	Alarm with instrument blocking
17	Input current higher than 22mA	Over Range Input mA	Alarm with instrument blocking (***)
18	Input current lower than 3.6mA	Under Range Input mA	Alarm with instrument blocking (***)

(*All the alarms with blocking function are valid if the menu item 3G5 is equal to YES)

(**The temperature sensor breakage alarm blocks the instrument if the menu item 3G6 is equal to HOLD)

(***The alarm blocks the instrument if the menu items 3E4 and 3E5 are different than OFF.)

Note:

- **Backlight:** In case of alarm the instrument turns on the Red backlight.
- **Reset Alarms Log:** On view Measure (Meas Icon) there is available an Alarm status menu; by pressing the **Enter** key, the **Alarms Menu** will be displayed.



Nota: Note: Alarms are stored in memory every 15 minutes, watch if the instrument is switched off loses alarms displayed in the last 14 minutes.

DosingPump.ir

ANNEX F: SSR1 AND SSR2 SETUP

Proportional frequency output with independent Proportional Band and SetPoint.

2C SSR1	
1: SetPoint	1.20ppm
2: Activ. Type	High
3: Pulse Max	400
4: Pulse min	1
5: Prop. Band	0.25ppm

01/05

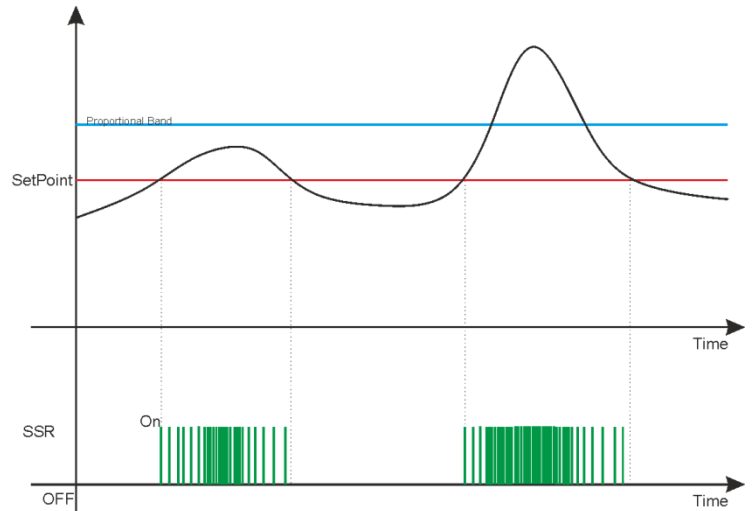

Note:



- **Pulse Max:** Set the maximum value of pulses for measure higher than the proportional band value.
- **Pulse min:** Set the minimum value of pulses for measure near the SetPoint value.
- **Pulse Technical Data:** Pulse On duration is fixed at 100mSeconds and time Off duration varies from 50mS (400 pulses per minute) to 59900mS (1 pulse per minute).



Notes: The Alarm Over Range function is not present on frequency output.

ANNEX G: MA1 AND MA2 SETUP

Current output proportional to the measure with range from 4 mA to 20 mA.

2E Output_mA1	
▶ 1: Start mA	0.00ppm
2: End mA	5.00ppm
3: Hold	NO
4: Namur	OFF
01/04	

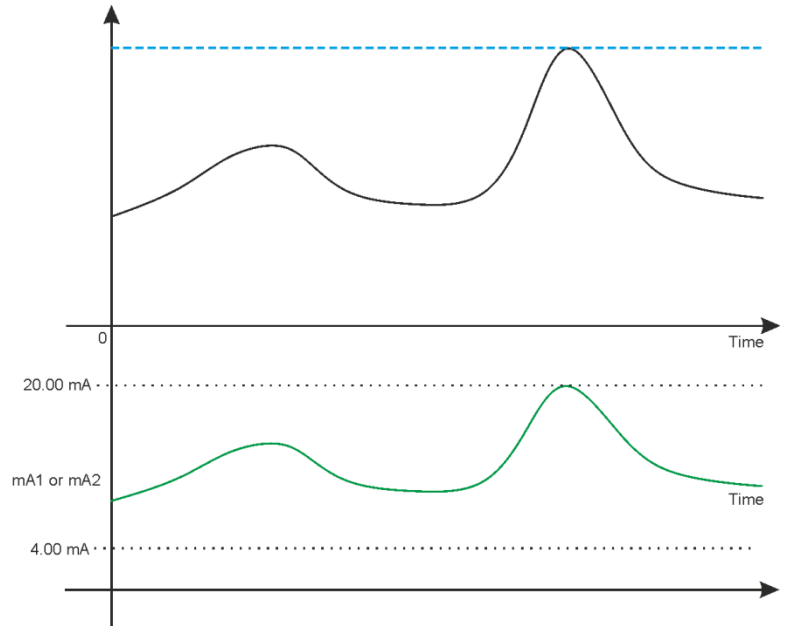

Note:



- **Start mA:** Minimum value of measure associated to 4 mA
- **End mA:** Maximum value of measure associated to 20 mA
- **Keep:** By setting the variable to YES, in case of alarm the instrument freezes the mA output to the last calculated value.
- **Namur:** By setting the variable to the value of 3.6 mA or 22 mA, in case of alarm the instrument sets the current output to the selected value.



ANNEX H: WIRING EXAMPLES

Power Supply:

- 12÷32Vdc or 100÷240Vac; Check the product label
- Observe the polarity
- Maximum Power Consumption 3.5 W or 5W

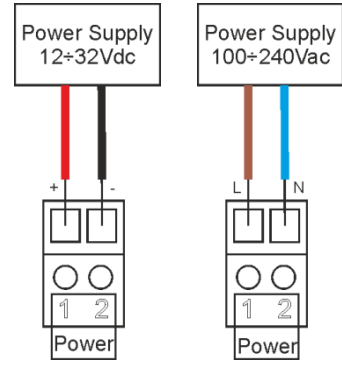

Frequency outputs SSR1 and SSR2:

- Contact closed 26Ω to 50mA, 125mA maximum load with an impedance of 36Ω.

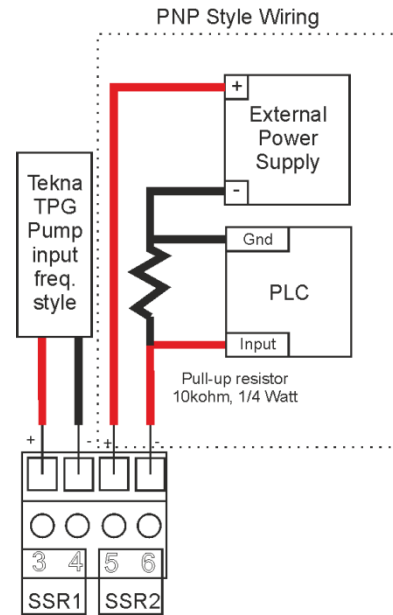
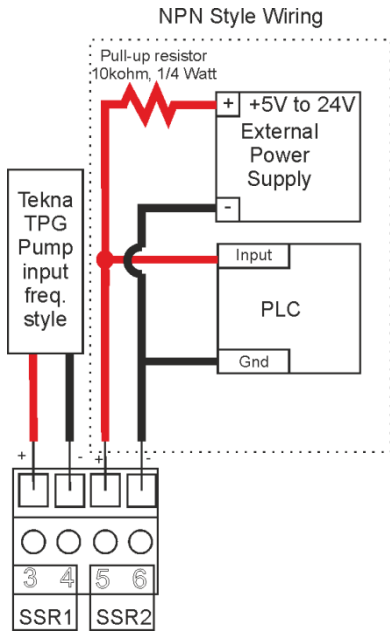

Relay outputs 1 and 2:

- Maximum load 5 A resistive

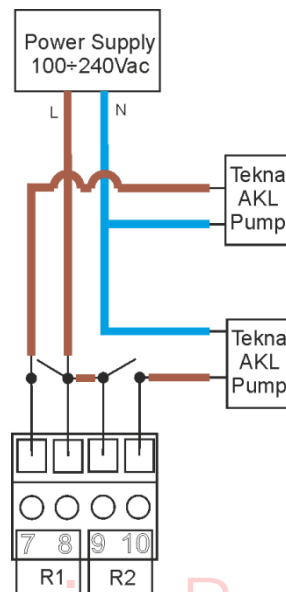

DosingPump.ir

Current outputs mA 1 and 2:

- 4-20mA with a maximum load of 800 ohm
- Observe the polarity of the cables

RS485 serial port output:

- Communication protocol ModBus RTU/ASCII.
- Add 120Ω termination resistor between A and B.
- Observe the polarity of the cables

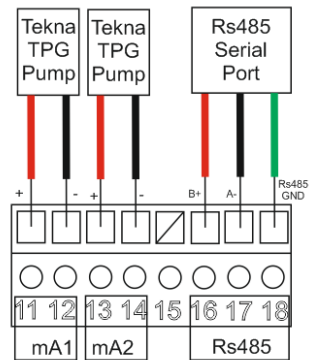

Rotor flow sensor input:

- Observe the polarity

Reed sensor input:

- Input for dry contact or semiconductor (Open Collector) 5Vcc, max 6mA.
- Maximum distance of the Reed sensor 20 meters of cable.

Hold signal input:

- Voltage signal from 12 to 32 Vdc
- Observe the polarity

Sensor Measure input:

- Attention, connect the probes with metal terminals
- Observe the polarity

Temperature measure input:

- Attention, connect the probes with metal terminals
- Observe the polarity
- Maximum distance of the PT100/PT1000 sensor 20 meters of cable
- Observe the wiring for the sensor, with 2, 3 and 4 wires; connect as indicated.

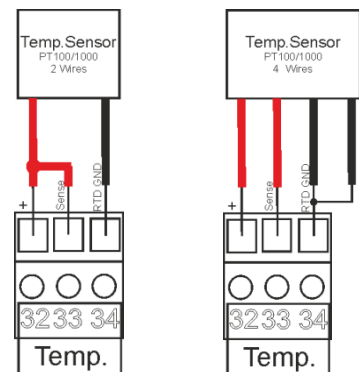
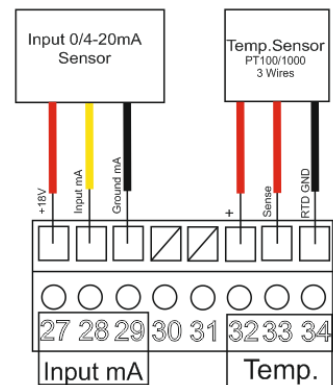
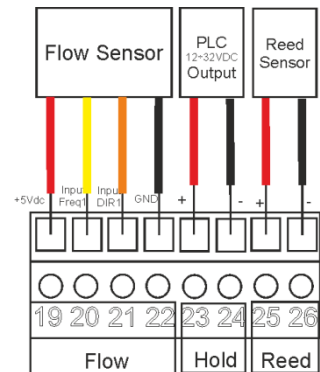

USB Port Input:

- USB Type B
- Power via USB port with activation of the microprocessor and display without back light.

ANNEX I: TROUBLESHOOTING.

Problem	Possible Cause
The display shows the symbol 	<ul style="list-style-type: none"> • See ANNEX E
Calibration Errors	<ul style="list-style-type: none"> • Contaminated buffer solutions (old) • Probe damaged or old • Probe cables damaged • Measure input of the instrument damaged
Data Memory Error	<ul style="list-style-type: none"> • Internal memory broken
Password Error	<ul style="list-style-type: none"> • Error value
Temperature Measure Error the display shows ---.-°C	<ul style="list-style-type: none"> • Temperature probe broken or disconnected
Measure Error	<ul style="list-style-type: none"> • Sensor not calibrated • Sensor not installed correctly • The sensor or the cable is defective • Electronic measure input damaged • The sensor cable exceeds the maximum length
Measure reading not stable	<ul style="list-style-type: none"> • Sensors or cables installed too close to devices that generate electrical noise. • Sensor installed on flow with hydraulic turbulence. • Average measure set too low. • Probe cables excessively long
Unable to display the Calibration or Setup menu	<ul style="list-style-type: none"> • User excluded for safety reasons
The display is turned off	<ul style="list-style-type: none"> • The instrument does not receive correct power supply. • LCD contrast is not set correctly. • The fuse has blown. • Hardware fault.
The display shows in the upper right corner "Diagnostic"	<ul style="list-style-type: none"> • Turn the instrument off and then on again; if the problem persists, contact your provider
Output 18V in short	<ul style="list-style-type: none"> • Wiring damaged

ANNEX L: DEFAULT PARAMETERS TABLE AND RESET TO DEFAULT

ADVANCED MENU						
Parameter	Sub-parameter	Default Value	Min Value	Max Value	Unit	
Language	---	EN (English)	EN,FR,IT,DE,ES			
Password	Password	0000	0000	9999		
	Cal Menu	NO	NO	YES		
	Setup Menu	NO	NO	YES		
Display	Contrast	0	-15	+15		
	Mode	ECO	OFF, ON, ECO			
	ON	100	10	100	%	
	ECO	50	0	50	%	
Measure	Inversion	OFF	OFF	ON		
	Measure Unit	ppm	ppm, ppb, mg/l, mA, Custom			
	Custom unit	(4 spaces)	up to 4 characters can be edited			
	Measure Name	Cl2	Cl2, PAA, H2O2, O3, Custom			
	Custom Name	(4 spaces)	up to 4 characters can be edited			
	Filter	Medium	Low, Medium, High			
	Decimal Point	XXX,XX	XXXXX, / XXXX,X / XXX,XX / XX,XXX / X,XXXX			
Measure Range	Sensor Type	4-20mA	0-20mA	4-20mA		
	Range Min	0	-99999	99999	XXXX	
	Range Max	99999	-99999	99999	XXXX	
	Over Range	OFF	OFF	22 mA		
	Under Range	OFF	OFF	3,6 mA		
	Temperature Meas.	Sensor Type	Manual	Manual	External	
Measure Unit		°C	°C	°F		
Manual Value		25,0 (77,0)	-50,0 (-58,0)	+150,0 (302,0)	°C (°F)	
Filter		Medium	Low, Medium, High			
Alarms Setting	Reed Logic	NO	NO	NC		
	Delay Activation REED	OFF	OFF (00':00")	60':59"	min:sec	
	Delay Activation HOLD	OFF	OFF (00':00")	60':59"	min:sec	
	Power Supply Interruption	NO	NO	YES		
	Instrument blocking	NO	NO	YES		
	Temperature Alarm	Notification	Notification	Block		
	Service	OFF	OFF (0)	365	Days	
Outputs Setting	Relay 1	OFF	OFF, Meas ON/OFF, Meas Timed, Meas. PWM, Temp. ON/OFF, Temp. Timed, Temp. PWM			
	Relay 2	OFF	OFF, Meas ON/OFF, Meas Timed, Meas. PWM, Temp. ON/OFF, Temp. Timed, Temp. PWM, Probe Wash, Alarm			
	SSR1	OFF	OFF, Measure, Temp.			
	SSR2	OFF				
	mA1	OFF	OFF, Measure, Temp.			
	mA2	OFF				
RS485 Setting	Activation	ON	OFF	ON		
	Mode	RTU	RTU	ASCII		
	Address	1	1	247		
	Speed	19200	1200, 2400, 4800, 9600, 19200, 38400, 57600, 115200			
	Parity	Even	None, Odd, Even			
	Stop Bit	1				
USB Setting	Reserved for future use					
Control Panel	Measure	---	0	24000	µA	
	Temperature Measure	---	-50,0	+150,0	°C	
	Simul. Relay 1	OFF	OFF	ON		
	Simul. Relay 2	OFF	OFF	ON		
	Simul. Freq 1	0	0	400	Imp/min	
	Simul. Freq 2	0	0	400	Imp/min	
	Simul. Out mA 1	4,00	3,00	23,00	mA	
	Simul. Out mA 2	4,00	3,00	23,00	mA	
	REED Input	---	OFF	ON		
	HOLD Input	---	OFF	ON		
	Statistics	No. Powen ON	0	0	9999999	Activations
		No. Alarms	0	0	9999999	Activations
		No. RL1 Activations	0	0	9999999	Activations
No. RL2 Activations		0	0	9999999	Activations	
No. REED Activations		0	0	9999999	Activations	
No. HOLD Activations		0	0	9999999	Activations	
Reset Statistics		NO	NO	YES		
System Reset	---	NO	NO	YES		
Firmware Revision	---	---	---	---		

SETUP MENU		Relay 1 = OFF, Relay 2 = OFF, SSR1 = OFF, SSR2 = OFF, mA1 = OFF, mA2 = OFF			
Parameter	Sub-parameter	Default Value	Min Value	Max Value	Unit
Relay 1	---	OFF	---	---	
Relay 2	---	OFF	---	---	
SSR1	---	OFF	---	---	
SSR2	---	OFF	---	---	
mA1	---	OFF	---	---	
mA2	---	OFF	---	---	

SETUP MENU		Measure Unit: xxxx				
Parameter	Sub-parameter 1	Sub-parameter 2	Default Value	Min Value	Max Value	Unit
Relay 1 / Relay 2 xxxx ON/OFF	SetPoint	---	0	-99999	99999	xxxx
	Type	---	Low	Low	High	
	Hysteresis	---	0	0,0000	99999	xxxx
	Hysteresis Time	---	OFF	OFF (00':00")	2':59"	min:sec
	Delay Start	---	00':01"	OFF (00':00")	60':59"	min:sec
	Delay End	---	00':01"	OFF (00':00")	60':59"	min:sec
	OFA	---	OFF	OFF (00h:00')	23h:59'	hours:min
	Over Range	---	0	0,0000	99999	xxxx
	Permanence	Status	OFF	OFF	ON	
		Interval	0	-99999	99999	xxxx
	Time	01':00"	OFF (00':00")	60':59"	min:sec	
Relay 1 / Relay 2 xxxx TIMED	Time On	---	00':10"	OFF (00':00")	60':59"	min:sec
	Time Off	---	00':10"	OFF (00':00")	60':59"	min:sec
Relay 1 / Relay 2 xxxx PWM	Interval	---	02':00"	OFF (00':00")	60':59"	min:sec
	Proportional Band	---	0	0,0000	99999	xxxx

SETUP MENU		Temperature Measure Unit: °C				
Parameter	Sub-parameter 1	Sub-parameter 2	Default Value	Min Value	Max Value	Unit
Relay 1 / Relay 2 °C ON/OFF	SetPoint	---	25,0	-50,0	150,0	°C
	Type	---	Low	Low	High	
	Hysteresis	---	0,0	0,0	10,0	°C
	Hysteresis Time	---	OFF	OFF (00':00")	2':59"	min:sec
	Delay Start	---	00':01"	OFF (00':00")	60':59"	min:sec
	Delay End	---	00':01"	OFF (00':00")	60':59"	min:sec
	OFA	---	OFF	OFF (00h:00')	23h:59'	hours:min
	Over Range	---	OFF	OFF (0,0)	150,0	°C
	Permanence	Status	OFF	OFF	ON	
		Interval	0,0	-50,0	150,0	°C
	Time	01':00"	OFF (00':00")	60':59"	min:sec	
Relay 1 / Relay 2 °C TIMED	Time On	---	00':10"	OFF (00':00")	60':59"	min:sec
	Time Off	---	00':10"	OFF (00':00")	60':59"	min:sec
Relay 1 / Relay 2 °C PWM	Interval	---	02':00"	OFF (00':00")	60':59"	min:sec
	Proportional Band	---	10,0	1,0	50,0	°C

DosingPump.ir

SETUP MENU		Temperature Measure Unit: °F					
Parameter	Sub-parameter 1	Sub-parameter 2	Default Value	Min Value	Max Value	Unit	
Relay 1 / Relay 2 °F ON/OFF	SetPoint	---	77,0	-58,0	302,0	°F	
	Type	---	Low	Low	High		
	Hysteresis	---	0,0	0,0	18,0	°F	
	Hysteresis Time	---	OFF	OFF (00':00")	2':59"	min:sec	
	Delay Start	---	00':01"	OFF (00':00")	60':59"	min:sec	
	Delay End	---	00':01"	OFF (00':00")	60':59"	min:sec	
	OFA	---	OFF	OFF (00h:00')	23h:59'	hours:min	
	Over Range	---	OFF	OFF (0,0)	270,0	°F	
	Permanence	Status		OFF	OFF	ON	
		Interval		0,0	-58,0	302,0	°F
Time			01':00"	OFF (00':00")	60':59"	min:sec	
Relay 1 / Relay 2 °F TIMED	Time On	---	00':10"	OFF (00':00")	60':59"	min:sec	
	Time Off	---	00':10"	OFF (00':00")	60':59"	min:sec	
Relay 1 / Relay 2 °F PWM	Interval	---	02':00"	OFF (00':00")	60':59"	min:sec	
	Proportional Band	---	18,0	1,8	90,0	°F	

SETUP MENU		Relay 2 = Probe Wash				
Parameter	Sub-parameter 1	Sub-parameter 2	Default Value	Min Value	Max Value	Unit
Relay 2 pH/mV Wash	Wash Time	---	OFF	OFF (00':00")	60':59"	min:sec
	Delay Stabilization	---	01':00"	OFF (00':00")	60':59"	min:sec
	Wait New Wash	---	24h:00'	OFF (00h:00')	99h:59'	hours:min

SETUP MENU		Relay 2 = Alarm				
Parameter	Sub-parameter 1	Sub-parameter 2	Default Value	Min Value	Max Value	Unit
Relay 2 Alrm	Over Range R1	---	NO	NO	YES	
	OFA R1	---	NO	NO	YES	
	Measure Permanence R1	---	NO	NO	YES	
	Alarm REED	---	NO	NO	YES	
	Alarm HOLD	---	NO	NO	YES	
	Alarm Temperature Probe	---	NO	NO	YES	

DosingPump.ir

SETUP MENU		Measure Unit: ppm			
Parameter	Sub-parameter 1	Default Value	Min Value	Max Value	Unit
SSR1 / SSR2 xxxx	SetPoint	0	-99999	99999	xxxx
	Type	Low	Low	High	
	Max Pulses	400	20	400	Imp/min
	Min Pulses	1	1	100	Imp/min
	Proportional Band	0	0,0000	99999	xxxx

SETUP MENU		Temperature Measure Unit: °C			
Parameter	Sub-parameter 1	Default Value	Min Value	Max Value	Unit
SSR1 / SSR2 °C	SetPoint	25,0	-50,0	150,0	°C
	Type	Low	Low	High	
	Max Pulses	400	20	400	Imp/min
	Min Pulses	1	1	100	Imp/min
	Proportional Band	10,0	1,0	50,0	°C

SETUP MENU		Temperature Measure Unit: °F			
Parameter	Sub-parameter 1	Default Value	Min Value	Max Value	Unit
SSR1 / SSR2 °F	SetPoint	77,0	-58,0	302,0	°F
	Type	Low	Low	High	
	Max Pulses	400	20	400	Imp/min
	Min Pulses	1	1	100	Imp/min
	Proportional Band	18,0	1,8	90,0	°F

DosingPump.ir

SETUP MENU		Measure Unit: xxxx			
Parameter	Sub-parameter 1	Default Value	Min Value	Max Value	Unit
mA1 / mA2 xxxx	Start mA	-99999	-99999	99999	xxxx
	End mA	99999	-99999	99999	xxxx
	Hold Measure	NO	NO	YES	
	Namur	OFF, 3,6mA, 22 mA			

SETUP MENU		Temperature Measure Unit: °C			
Parameter	Sub-parameter 1	Default Value	Min Value	Max Value	Unit
mA1 / mA2 °C	Start mA	-50,0	-50,0	150,0	°C
	End mA	150,0	-50,0	150,0	°C
	Hold Measure	NO	NO	YES	
	Namur	OFF, 3,6mA, 22 mA			

SETUP MENU		Temperature Measure Unit: °F			
Parameter	Sub-parameter 1	Default Value	Min Value	Max Value	Unit
mA1 / mA2 °F	Start mA	-58,0	-58,0	302,0	°F
	End mA	302,0	-58,0	302,0	°F
	Hold Measure	NO	NO	YES	
	Namur	OFF, 3,6mA, 22 mA			

RESET THE DEFAULT PARAMETERS OF THE INSTRUMENT

To load all the default parameters of the instrument and also remove the password, proceed as follows:

- Disconnect the instrument from the power supply
- Press and hold simultaneously **Down** and **Enter** and power the instrument.
- At startup the instrument will execute a hidden menu
- Will be displayed the following message (picture on the Side)
- Select "YES" to perform the **RESET TO DEFAULT**.
- The instrument turns on and performs the **STARTUP** function .

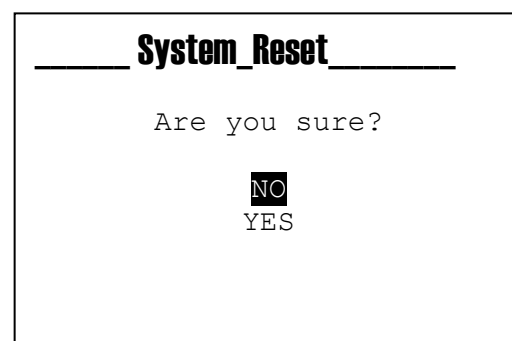

MODBUS PROFILE

Read Only Registers				Range of Data			
Address	Index Menu	Type of Register	Description	min	max	Type of data	Note
1000	-	Status Register	Status Register L **				
1001	-	Status Register	Status Register H ***	0x00000000	0x0001FFFF	Unsigned 32bit	
1002	-	Output Register	Relay 1 *	0	3	Unsigned 16bit	
1003	-	Output Register	Relay 2 *	0	3	Unsigned 16bit	
1004	-	Output Register	SSR 1 *	0	400	Unsigned 16bit	Pulse/minute
1005	-	Output Register	SSR 2 *	0	400	Unsigned 16bit	Pulse/minute
1006	-	Output Register	mA 1 *	360	2200	Unsigned 16bit	Nr. Decimals = 2
1007	-	Output Register	mA 2 *	360	2200	Unsigned 16bit	Nr. Decimals = 2
1008	-	Measure	Main Measure L				
1009	-	Measure	Main Measure H	-99999	99999	Signed 32bit	
1010	-	Measure	Dec Main Measure	0	4	Unsigned 16bit	
1011	-	Temp Measure	Temp Measure	-500(°C),-580(°F)	1500(°C),3020(°F)	Signed 16bit	Nr. Decimal = 1
1012	-	Temp Measure	Temp Measure Dec Point	1	1	Unsigned 16bit	
1013	3D1	Measure	Main Measure Unit	0-4(ppm, ppb, mg/l, mA, Custom)		Unsigned 16bit	
1014	3F2	Temp Measure	Temp Measure Unit	0(°C)	1(°F)	Unsigned 16bit	
1015	3H1	Output Configuration	Relay 1 ****	0	6	Unsigned 16bit	
1016	3H2	Output Configuration	Relay 2 ****	0	8	Unsigned 16bit	
1017	3H3	Output Configuration	SSR1 *****	0	2	Unsigned 16bit	
1018	3H4	Output Configuration	SSR2 *****	0	2	Unsigned 16bit	
1019	3H5	Output Configuration	mA1 *****	0	2	Unsigned 16bit	
1020	3H6	Output Configuration	mA2 *****	0	2	Unsigned 16bit	
1021	3M1	Control Panel	Raw Main Measure L				
1022		Control Panel	Raw Main Measure H	0	24000	Unsigned 32bit	µA
1023	3M2	Control Panel	Raw Temp Measure	-500(°C),-580(°F)	1500(°C),3020(°F)	Signed 16bit	Nr. Decimal = 1
1024	3N1	Statistics	Nr. Power On L				
1025		Statistics	Nr. Power On H	0	9999999	Unsigned 32bit	
1026	3N2	Statistics	Nr. Alarms L				
1027		Statistics	Nr. Alarms H	0	9999999	Unsigned 32bit	
1028	3N3	Statistics	Nr. Activationsi RL1L				
1029		Statistics	Nr. Activationsi RL1H	0	9999999	Unsigned 32bit	
1030	3N4	Statistics	Nr. Activations RL2L				
1031		Statistics	Nr. Activations RL2H	0	9999999	Unsigned 32bit	
1032	3N5	Statistics	Nr. Activations REEDL				
1033		Statistics	Nr. Activations REEDH	0	9999999	Unsigned 32bit	
1034	3N6	Statistics	Nr. Activations HOLDL				
1035		Statistics	Nr. Activations HOLDH	0	9999999	Unsigned 32bit	
1036	3M9	Control Panel	REED	0(Inactive)	1(Active)	Unsigned 16bit	
1037	3M10	Control Panel	HOLD	0(Inactive)	1(Active)	Unsigned 16bit	
1038							
1039		Not Used	Not Used	0	0	Unsigned 16bit	
1040							
1041	1A4	Calibrations	Calibration Type	0(None), 1(One Point), 2(Two Points)		Unsigned 16bit	
1042		Calibrations	Point 1 L				
1043		Calibrations	Point 1 H	-99999	99999	Signed 32bit	
1044		Calibrations	Dec Point 1	0	4	Unsigned 16bit	
1045		Calibrations	Point 2 L				
1046		Calibrations	Point 2 H	-99999	99999	Signed 32bit	
1047		Calibrations	Dec Point 2	0	4	Unsigned 16bit	
1048		Calibrations	Gain L				
1049		Calibrations	Gain H	0	99999	Unsigned 32bit	
1050		Calibrations	Dec Gain	0	4	Unsigned 16bit	
1051		Calibrations	Offset L				
1052		Calibrations	Offset H	-99999	99999	Signed 32bit	
1053		Calibrations	Dec Offset	0	4	Unsigned 16bit	
1054		Calibrations	Adjust L				
1055		Calibrations	Adjust H	-99999	99999	Signed 32bit	
1056		Calibrations	Dec Adjust	0	4	Unsigned 16bit	
1057	3D2	Measure	Measure Unit Custom L	0x2020	0x7A7A	Unsigned 32bit	View Example 1
1058		Measure	Measure Unit Custom H	0x2020	0x7A7A		
1059	3D3	Measure	Main Measure Name	0-4(Cl2,PAA,H2O2,O3, Custom)		Unsigned 16bit	
1060	3D4	Measure	Measure Name Custom L	0x2020	0x7A7A	Unsigned 32bit	View Example 2
1061		Measure	Measure Name Custom H	0x2020	0x7A7A		
1062	3E1	Measure	Sensor Type	0(0-20mA)	1(4-20mA)	Unsigned 16bit	
1063	3E2	Measure	Range Min L				
1064		Measure	Range Min H	-99999	99999	Signed 32bit	
1065		Measure	Dec Range Min	0	4	Unsigned 16bit	
1066	3E3	Measure	Range Max L				
1067		Measure	Range max H	-99999	99999	Signed 32bit	
1068		Measure	Dec Range Max	0	4	Unsigned 16bit	
1069	3E4	Measure	Over Current Alarm	0(OFF)	1(ON)	Unsigned 16bit	
1070	3E5	Measure	Under Current Alarm	0(OFF)	1(ON)	Unsigned 16bit	

DosingPump.ir

*	Relay 1	Value	
		0	OFF
		1	ON
		2	OFF (timed)
		3	ON (timed)
*	Relay 2	Value	
		0	OFF
		1	ON
		2	OFF (timed)
		3	ON (timed)
*	SSR1	Value	Pulse Minute
*	SSR2	Value	Pulse Minute
*	mA1	Value	Out mA Value
*	mA2	Value	Out mA Value

**	Status Register L	Bit	
		0	5V Fault
		1	Hold Status
		2	Reed Status
		3	Service
		4	Power Line Interruption
		5	Temp Probe Fault
		6	OUT 1 Over Range
		7	OUT 2 Over Range
		8	OUT 1 OFA 1
		9	OUT 2 OFA 1
		10	OUT 1 OFA 2
		11	OUT 2 OFA 2
		12	OUT 1 Holding Alarm
		13	OUT 2 Holding Alarm
		14	Input mA < 3,6 mA
		15	Input mA > 22 mA
***	Status Register H	Bit	
		0	Fault +18V
		1-15	Not Used

*****	Relay Configuration	Value	
		0	Disable
		1	ON_OFF Measure
		2	Timed Measure
		3	PWM Measure
		4	ON_OFF Temp
		5	Timed Temp
		6	PWM Temp
	ONLY RELE 2	7	Probe Washing
	ONLY RELE 2	8	Alarm

*****	SSR/mA Configuration	Value	
		0	Disable
		1	Measure
		2	Temp

Example 1, Measure Unit Custom

es. m3/h

Character 4	Character 3	Character 2	Character 1
h	/	3	m
0x68	0x2F	0x33	0x6D

Measure Unit Custom L = 0x336D

Measure Unit Custom H = 0x682F

Measure Unit Custom = 0x682F336D (m3/h)

Example 2, Measure Name Custom

es. Flow

Character 4	Character 3	Character 2	Character 1
w	o	l	F
0x77	0x6F	0x6C	0x46

Measure Name Custom L = 0x6C46

Measure Name Custom H = 0x776F

Measure Name Custom = 0x776F6C46 (Flow)

ASCII Table

Simbol	Dec	Hex	Simbol	Dec	Hex	Simbol	Dec	Hex
(space)	32	20	>	62	3E	\	92	5C
!	33	21	?	63	3F]	93	5D
"	34	22	@	64	40	^	94	5E
#	35	23	A	65	41	_	95	5F
\$	36	24	B	66	42	`	96	60
%	37	25	C	67	43	a	97	61
&	38	26	D	68	44	b	98	62
'	39	27	E	69	45	c	99	63
(40	28	F	70	46	d	100	64
)	41	29	G	71	47	e	101	65
*	42	2A	H	72	48	f	102	66
+	43	2B	I	73	49	g	103	67
,	44	2C	J	74	4A	h	104	68
-	45	2D	K	75	4B	i	105	69
.	46	2E	L	76	4C	j	106	6A
/	47	2F	M	77	4D	k	107	6B
0	48	30	N	78	4E	l	108	6C
1	49	31	O	79	4F	m	109	6D
2	50	32	P	80	50	n	110	6E
3	51	33	Q	81	51	o	111	6F
4	52	34	R	82	52	p	112	70
5	53	35	S	83	53	q	113	71
6	54	36	T	84	54	r	114	72
7	55	37	U	85	55	s	115	73
8	56	38	V	86	56	t	116	74
9	57	39	W	87	57	u	117	75
:	58	3A	X	88	58	v	118	76
;	59	3B	Y	89	59	w	119	77
<	60	3C	Z	90	5A	x	120	78
=	61	3D	[91	5B	y	121	79
						z	122	7A

Read Write Registers				ppm,ppb,mg/l, mA, Custom		°C		°F			
Address	Index Menu	Type of Register	Description	min	max	min	max	min	max	Type of Data	Note
3000	-	NOT USED	NOT USED	0	0	0	0	0	0	Unsigned 16bit	
3001	-	NOT USED	NOT USED	0	0	0	0	0	0	Unsigned 16bit	
3002	-	NOT USED	NOT USED	0	0	0	0	0	0	Unsigned 16bit	
3003	-	NOT USED	NOT USED	0	0	0	0	0	0	Unsigned 16bit	
3004	3E1	Temp Sensor Type	Temp Enable	0(manual)	1(probe)	0(manual)	1(probe)	0(manual)	1(probe)	Unsigned 16bit	
3005	3E3	Manual Temp	Manual Temperature L	-----	-----	-500	1500	-580	3020	Signed 32bit	Nr. Decimals = 1
3006		Manual Temp	Manual Temperature H								
3007	3G5	Alarm Config.	Instrument Block	0(Disable)	1(Enable)	0(Disable)	1(Enable)	0(Disable)	1(Enable)	Unsigned 16bit	
3008	3G6	Alarm Config.	Temperature Alarm	0(Notify)	1(Block)	0(Notify)	1(Block)	0(Notify)	1(Block)	Unsigned 16bit	
3100	2A1	RELAY 1	Setpoint tL	-99999	99999	-500	1500	-580	3020	Signed 32bit	
3101		RELAY 1	Setpoint H								
3102		RELAY 1	Dec Setpoint								
3103	2A2	RELAY 1	Type	0(High)	1(Low)	0(High)	1(Low)	0(High)	1(Low)	Unsigned 16bit	
3104	2A3	RELAY 1	Hysteresis L	0	99999	0	100	0	180	Signed 32bit	
3105		RELAY 1	Hysteresis H								
3106		RELAY 1	Decimal Hysteresis								
3107	2A4	RELAY 1	Hysteresis Time L	0	120	0	120	0	120	Unsigned 32bit	Seconds
3108		RELAY 1	Hysteresis Time H								
3109	2A5	RELAY 1	Delay Start L	1	3600	1	3600	1	3600	Unsigned 32bit	Seconds
3110		RELAY 1	Delay Start H								
3111	2A6	RELAY 1	Delay End L	1	3600	1	3600	1	3600	Unsigned 32bit	Seconds
3112		RELAY 1	Delay End H								
3113	2A7	RELAY 1	OFA L	0	1439	0	1439	0	1439	Unsigned 32bit	Minutes
3114		RELAY 1	OFA H								
3115	2A8	RELAY 1	Over Range L	0	99999	0	1500	0	2700	Signed 32bit	
3116		RELAY 1	Over Range H								
3117		RELAY 1	Decimal Over Range								
3118	2A9A	RELAY 1	Permanece Status	0(Disable)	1(Enable)	0(Disable)	1(Enable)	0(Disable)	1(Enable)	Unsigned 16bit	
3119	2A9B	RELAY 1	Permanece Range L	-99999	99999	-500	1500	-580	3020	Signed 32bit	
3120		RELAY 1	Permanece Range H								
3121		RELAY 1	Permanece Range Dec								
3122	2A9C	RELAY 1	Permanece Time L	0	3600	0	3600	0	3600	Unsigned 32bit	Seconds
3123		RELAY 1	Permanece Time H								
3124	2A10	RELAY 1	Time On L	0	3600	0	3600	0	3600	Unsigned 32bit	Seconds
3125		RELAY 1	Time On H								
3126	2A11	RELAY 1	Time Off L	0	3600	0	3600	0	3600	Unsigned 32bit	Seconds
3127		RELAY 1	Time Off H								
3128	2A10	RELAY 1	Period L	0	3600	0	3600	0	3600	Unsigned 32bit	Seconds
3129		RELAY 1	Period H								
3130	2A11	RELAY 1	Proportional Band L	0	99999	10	500	18	900	Signed 32bit	
3131		RELAY 1	Proportional Band H								
3132		RELAY 1	Proportional Band Dec								
3200	2B1	RELAY 2	Setpoint tL	-99999	99999	-500	1500	-580	3020	Signed 32bit	
3201		RELAY 2	Setpoint H								
3202		RELAY 2	Dec Setpoint								
3203	2B2	RELAY 2	Type	0(High)	1(Low)	0(High)	1(Low)	0(High)	1(Low)	Unsigned 16bit	
3204	2B3	RELAY 2	Hysteresis L	0	99999	0	100	0	180	Signed 32bit	
3205		RELAY 2	Hysteresis H								
3206		RELAY 2	Decimal Hysteresis								
3207	2B4	RELAY 2	Hysteresis Time L	0	120	0	120	0	120	Unsigned 32bit	Seconds
3208		RELAY 2	Hysteresis Time H								
3209	2B5	RELAY 2	Delay Start L	1	3600	1	3600	1	3600	Unsigned 32bit	Seconds
3210		RELAY 2	Delay Start H								
3211	2B6	RELAY 2	Delay End L	1	3600	1	3600	1	3600	Unsigned 32bit	Seconds
3212		RELAY 2	Delay End H								
3213	2B7	RELAY 2	OFA L	0	1439	0	1439	0	1439	Unsigned 32bit	Minutes
3214		RELAY 2	OFA H								
3215	2B8	RELAY 2	Over Range L	0	99999	0	1500	0	2700	Signed 32bit	
3216		RELAY 2	Over Range H								
3217		RELAY 2	Decimal Over Range								
3218	2B9A	RELAY 2	Permanece Status	0(Disable)	1(Enable)	0(Disable)	1(Enable)	0(Disable)	1(Enable)	Unsigned 16bit	
3219	2B9B	RELAY 2	Permanece Range L	-99999	99999	-500	1500	-580	3020	Signed 32bit	
3220		RELAY 2	Permanece Range H								
3221		RELAY 2	Permanece Range Dec								
3222	2B9C	RELAY 2	Permanece Time L	0	3600	0	3600	0	3600	Unsigned 32bit	Seconds
3223		RELAY 2	Permanece Time H								
3224	2B10	RELAY 2	Time On L	0	3600	0	3600	0	3600	Unsigned 32bit	Seconds
3225		RELAY 2	Time On H								
3226	2B11	RELAY 2	Time Off L	0	3600	0	3600	0	3600	Unsigned 32bit	Seconds
3227		RELAY 2	Time Off H								
3228	2B10	RELAY 2	Interval L	0	3600	0	3600	0	3600	Unsigned 32bit	Seconds
3229		RELAY 2	Interval H								

Read Write Registers				ppm,ppb,mg/l,mA,Custom		°C		°F		Type of Data	Note
Address	Index Menu	Type of Register	Description	min	max	min	max	min	max		
3230	2B11	RELAY 2	Proportional Band L	0	99999	10	500	18	900	Signed 32bit	
3231		RELAY 2	Proportional Band H								
3232		RELAY 2	Proportional Band Dec								
3233	2B1	RELAY 2	Wash Time L	0	3600	0	3600	0	3600	Unsigned 32bit	Seconds
3234		RELAY 2	Wash Time H								
3235	2B2	RELAY 2	Delay Stabilization L	0	3600	0	3600	0	3600	Unsigned 32bit	Seconds
3236		RELAY 2	Delay Stabilization H								
3237	2B3	RELAY 2	Wait New Wash L	0	5999	0	5999	0	5999	Unsigned 32bit	Minutes
3238		RELAY 2	Wait New Wash H								
3239	2B1	RELAY 2	Over Range R1	0(Disable)	1(Enable)	0(Disable)	1(Enable)	0(Disable)	1(Enable)	Unsigned 16bit	
3240	2B2	RELAY 2	OFA R1	0(Disable)	1(Enable)	0(Disable)	1(Enable)	0(Disable)	1(Enable)	Unsigned 16bit	
3241	2B3	RELAY 2	Measure Permanence R1	0(Disable)	1(Enable)	0(Disable)	1(Enable)	0(Disable)	1(Enable)	Unsigned 16bit	
3242	2B4	RELAY 2	REED Alarm	0(Disable)	1(Enable)	0(Disable)	1(Enable)	0(Disable)	1(Enable)	Unsigned 16bit	
3243	2B5	RELAY 2	HOLD Alarm	0(Disable)	1(Enable)	0(Disable)	1(Enable)	0(Disable)	1(Enable)	Unsigned 16bit	
3244	2B6	RELAY 2	Temp. Probe Alarm	0(Disable)	1(Enable)	0(Disable)	1(Enable)	0(Disable)	1(Enable)	Unsigned 16bit	
3300	2C1	SSR 1	Setpoint L	-99999	99999	-500	1500	-580	3020	Signed 32bit	
3301		SSR 1	Setpoint H								
3302		SSR 1	Decimal Setpoint								
3303	2C2	SSR 1	Type	0(High)	1(Low)	0(High)	1(Low)	0(High)	1(Low)	Unsigned 16bit	
3304	2C3	SSR 1	Max Pulses	20	400	20	400	20	400	Unsigned 16bit	Pulse/minutes
3305	2C4	SSR 1	Min Pulses	1	100	1	100	1	100	Unsigned 16bit	Pulse/minutes
3306	2C5	SSR 1	Proportional Band L	0	99999	10	500	18	900	Signed 32bit	
3307		SSR 1	Proportional Band H								
3308		SSR 1	Decimal Proportional Band								
3400	2D1	SSR 2	Setpoint L	-99999	99999	-500	1500	-580	3020	Signed 32bit	
3401		SSR 2	Setpoint H								
3402		SSR 2	Decimal Setpoint								
3403	2D2	SSR 2	Type	0(High)	1(Low)	0(High)	1(Low)	0(High)	1(Low)	Unsigned 16bit	
3404	2D3	SSR 2	Max Pulses	20	400	20	400	20	400	Unsigned 16bit	Pulse/minutes
3405	2D4	SSR 2	Min Pulses	1	100	1	100	1	100	Unsigned 16bit	Pulse/minutes
3406	2D5	SSR 2	Proportional Band L	0	99999	10	500	18	900	Signed 32bit	
3407		SSR 2	Proportional Band H								
3408		SSR 2	Decimal Proportional Band								
3500	2E1	m A1	Start mA L	-99999	99999	-500	1500	-580	3020	Signed 32bit	
3501		m A1	Start mA H								
3502		m A1	Decimal Start mA								
3503	2E2	m A1	End mA L	-99999	99999	-500	1500	-580	3020	Signed 32bit	
3504		m A1	End mA H								
3505		m A1	Decimal End mA								
3506	2E3	m A1	Hold Measure	0(Disable)	1(Enable)	0(Disable)	1(Enable)	0(Disable)	1(Enable)	Unsigned 16bit	
3507	2E4	m A1	Namur	0(OFF), 1(3,6mA),2(22mA)		0(OFF), 1(3,6mA),2(22mA)		0(OFF), 1(3,6mA),2(22mA)		Unsigned 16bit	
3508	2F1	m A2	Start mA L	-99999	99999	-500	1500	-580	3020	Signed 32bit	
3509		m A2	Start mA H								
3510		m A2	Decimal Start mA								
3511	2F2	m A2	End mA L	-99999	99999	-500	1500	-580	3020	Signed 32bit	
3512		m A2	End mA H								
3513		m A2	Decimal End mA								
3514	2F3	m A2	Hold Measure	0(Disable)	1(Enable)	0(Disable)	1(Enable)	0(Disable)	1(Enable)	Unsigned 16bit	
3515	2F4	m A2	Namur	0(OFF), 1(3,6mA),2(22mA)		0(OFF), 1(3,6mA),2(22mA)		0(OFF), 1(3,6mA),2(22mA)		Unsigned 16bit	

Write Only Register

4000		Command Register	Command	MODBUS_REG_CMD ***
------	--	------------------	---------	--------------------

MODBUS_REG_CMD	Value to send to request a command execution
0	None
1	Read Eeprom and copy in Ram
2	Write in Eeprom the Ram Data
3	Reset Statistics Data

DosingPump.ir