

seko

Pumps & Accessories for Water Treatment & Industry



Your Choice,
Our Commitment

DosingPump.ir

Contents

Introduction	3
Seko Connectivity Platform	6
Introducing SekoWeb	8
Solenoid-Driven Dosing Pumps	10
• Tekba-R, Tekba, Komba, Tekna, Kompact, Invikta	
Motor-Driven Dosing Pumps	30
• Kosmo MM2 & MM1	
• Spring PS2, PS1, MS1, MSV	
• Spring with Elektra, Elektra Portal	
• Spring PS2 HP, MS1 AVS®	
Peristaltic Dosing Pumps	58
• Kronos 65, 50, 20	
AODD Pumps	68
• Duotek	
Side Channel Blowers	92
Accessories	114
Vision and Values	126

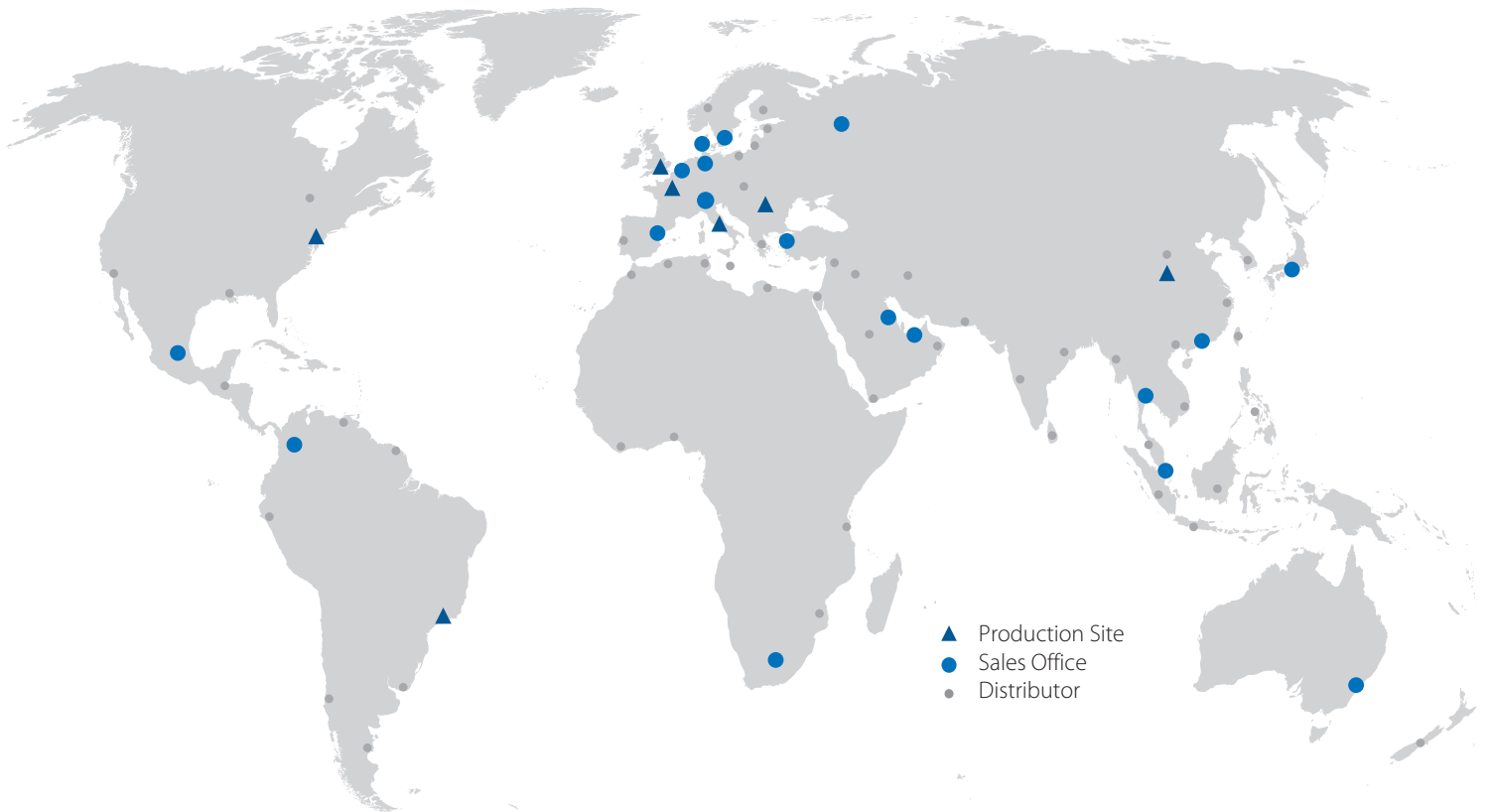

seko

Globally Present, Locally Active

A Worldwide Group at your service

Our Global presence ensures that we can support our Customers wherever they are. Supported by teams in over 20 countries, as well as by our accredited Partner Distributor network, we ensure professional, local customer support in over 120 countries, with the added benefit of rapid delivery of goods to meet your needs.

All this backed up and supported by a world-class team of Technical Customer Service, able to provide all the back up or technical support needed. With ISO certificated production sites in Europe, the Americas and Asia, we are close to our customers and fully compliant with all local norms both in terms of our product designs as much as our production facilities.

DosingPump.ir

How SEKO works for you

From the spark of an idea, through to the delivery of a solution, SEKO is with you all the way

SEKO supports its customers in every phase of a project, from the inception of an idea or request, through design and testing to launch and installation. Our in-house research, design and development teams work closely with the local teams, drawing on customer and market inputs. Then using state-of-the-art technologies to optimize costs and using our own specifically designed test benches to ensure rigorous, robust testing, we ensure a quality solution is delivered quickly to market.

No matter which processes and applications are planned SEKO has a solution in the cleaning and hygiene of kitchens and laundries and surfaces of all types in applications like Offices and Restaurants, Hospitals and Hotels, Retailers and Schools, Car Washes and Swimming Pools, Cooling Towers, Energy, Food & Beverage, Water & Gas Utilities Potable and Waste Water Treatment.

Partnership philosophy

Being a privately-owned business means that we are here for the long term and can plan projects with and for our Customers, where both parties benefit. It means we can rapidly take decisions to invest our resources to ensure our optimum solutions are delivered.

Your Business, Our Solutions

Our extensive product range represents a unique combination of design, development and implementation know how. With a wide and ever evolving range of products and ancillaries, we can offer specific and comprehensive solutions for a variety of industrial applications. Our solutions are conceived to fit seamlessly into your operation, optimizing the processes and applications.

Uniquely positioned

SEKO's 3 business units, Cleaning & Hygiene, Water and Industry and Industrial Processes puts us in a unique position to be able to respond to the widest range of business needs, with a broad range that allows you the Customer to deal with just one company, simple.

DosingPump.ir

Water-Treatment Applications

Ever-evolving solutions to safeguard our most precious resource

Water is becoming increasingly scarce, and as a result the water-treatment market has seen rapid growth since the late 1990s. Those working in the sector now encounter increasingly complex challenges, from guaranteeing high water quality to meeting ever-more closely monitored regulations.

From the treatment of water for human consumption to the water used in cooling water treatment and the use of water in myriad industrial processes, SEKO continues to enjoy a strong reputation as a reliable and consistent partner delivering solutions tailored to meet any given need. Exploiting our market experience, we design, develop, test and manufacture solutions and systems that deliver:

Precision and Consistency

SEKO's systems allow you to manage the total cost of ownership of your system whilst guaranteeing accurate measurement of critical water parameters. Chemically compatible raw materials, chosen for their robustness and durability, are exemplified by our five-year diaphragm guarantee and ATEX certification on selected pumps, providing peace of mind and brand security.

Ease of Use and Installation

As a global company, we are attuned to the differing needs of individual markets. This is why, when we design a new product, we ensure that installation is simple and that we use uniform programming language solutions that are intuitive and easy to understand, in whatever language you speak.

Operational Efficiency

SEKO's pumps offer an exceptional mix of affordability and high performance across solenoid and electro-mechanical pump applications. These include thoughtful design elements such as adjustable stroke length; single wetted parts options; stabilized power supply; multiple model outputs in a single pump footprint; base or wall mounting and common programming language for a new standard in operational efficiency.



SEKO Connectivity Platform

How the Internet of Things (IoT) works

An IoT ecosystem consists of web-enabled smart devices that use embedded processors, sensors and communication hardware to collect, send and act on data they acquire from their environments.

IoT devices share the sensor data they collect by connecting to an IoT gateway or other edge device, where data is either sent to the cloud to be analyzed fully (with analysis and comparison possible), or locally (limited to the data acquired).

Sometimes, these devices communicate with other related devices and act on the information they get from one another. The devices do most of the work without human intervention, although people can interact with the devices, for instance, to set them up, give them instructions or access the data.

IoT offers a number of benefits to organizations, enabling them to:

- Monitor their overall business processes
- Integrate and adapt business models
- Improve customer experience
- Make better business decisions
- Save time and money
- Generate more revenue
- Enhance employee productivity

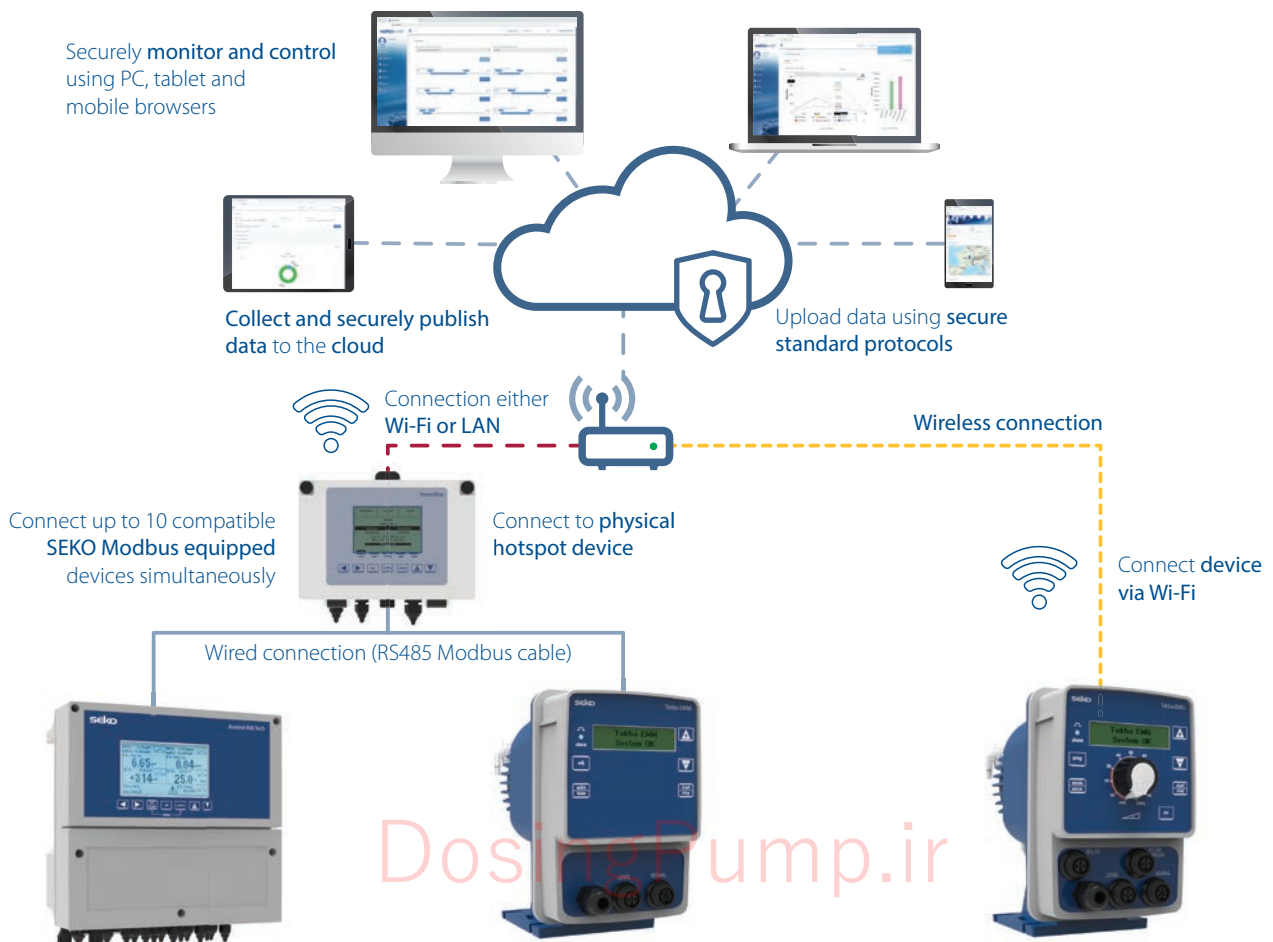

SekoWeb & Data on Demand

In today's connected world, customers expect to manage their equipment from a PC, laptop or smart device, using the Internet of Things to access operational information at their convenience. Whether viewing data in real time or analyzing it historically, remote connectivity allows costs to be optimized through targeted maintenance or problem solving, ensuring downtime is kept to a minimum.

Always at the forefront of technological innovation, SEKO has brought IoT to its class-leading controllers and dosing systems*, connecting plant operators to their equipment like never before.

Via the bespoke SekoWeb platform, users enjoy unparalleled access to live data and can make vital adjustments to their water-treatment operation 24 hours a day from any location worldwide.

Along with significant efficiency improvements, operators benefit from 24/7 awareness of system status for all their equipment across multiple installations, providing complete peace of mind.

Fully scalable, SEKO's systems are set up to allow users from the largest global multi-national to the independent engineering company to maximize their operations and running costs with a solution that ensures data is always available on demand, regardless of the application. Features include:

- Overall operating costs
- Chemical usage
- Programmes
- Parameters set
- Alarm reporting
- Data analysis
- Map geolocation



KommBox

Although some SEKO devices have an internal Wi-Fi module that allows them to connect directly to the web, sometimes these systems must be installed in places where Wi-Fi signal is weak. With this in mind, SEKO has developed systems equipped with a wired Modbus interface, which can be connected to an external communication device located where Wi-Fi signal is strong.

This device is known as KommBox, a unit that can be physically connected to all SEKO devices fitted with a Modbus serial port (*) to provide a Wi-Fi or ethernet interface. Essentially, KommBox is a gateway that acts as a hub between the several Modbus devices present in a plant and the Wi-Fi or LAN channel available – and therefore the web.

KommBox can use any internet connection available in the plant – Wi-Fi or LAN – and, once configured and installed, the connected devices can be accessed directly from the SekoWeb portal from anywhere in the world by users with the appropriate credentials.

KommBox features an intuitive wizard installation system for devices as they are loaded, making the process quick, simple and straightforward. And, once the products have been installed, they are visible in the SekoWeb portal.

(*) Available on products across the SEKO range, identifiable by this icon.



Features

- Able to manage up to 10 devices in the same wired Modbus RS485 network
- Wi-Fi board and LAN input use every available internet connection in order to send periodical data to SekoWeb
- Configurable as a hot spot for accessing the internal web server
- Independent 100 – 240V power supply
- Internal battery for a local clock
- Seven-key user interface
- Backlit three-colour graphic display



Introducing SekoWeb

Whether you're a technician or an end user, SEKO has IoT-enabled remote access solutions for achieving and maintaining perfect water quality in your application.

Housing state-of-the-art technology within intuitive interfaces, SekoWeb has been designed with the user in mind to make remote water-treatment plant management quick, easy and cost-effective.



seko web

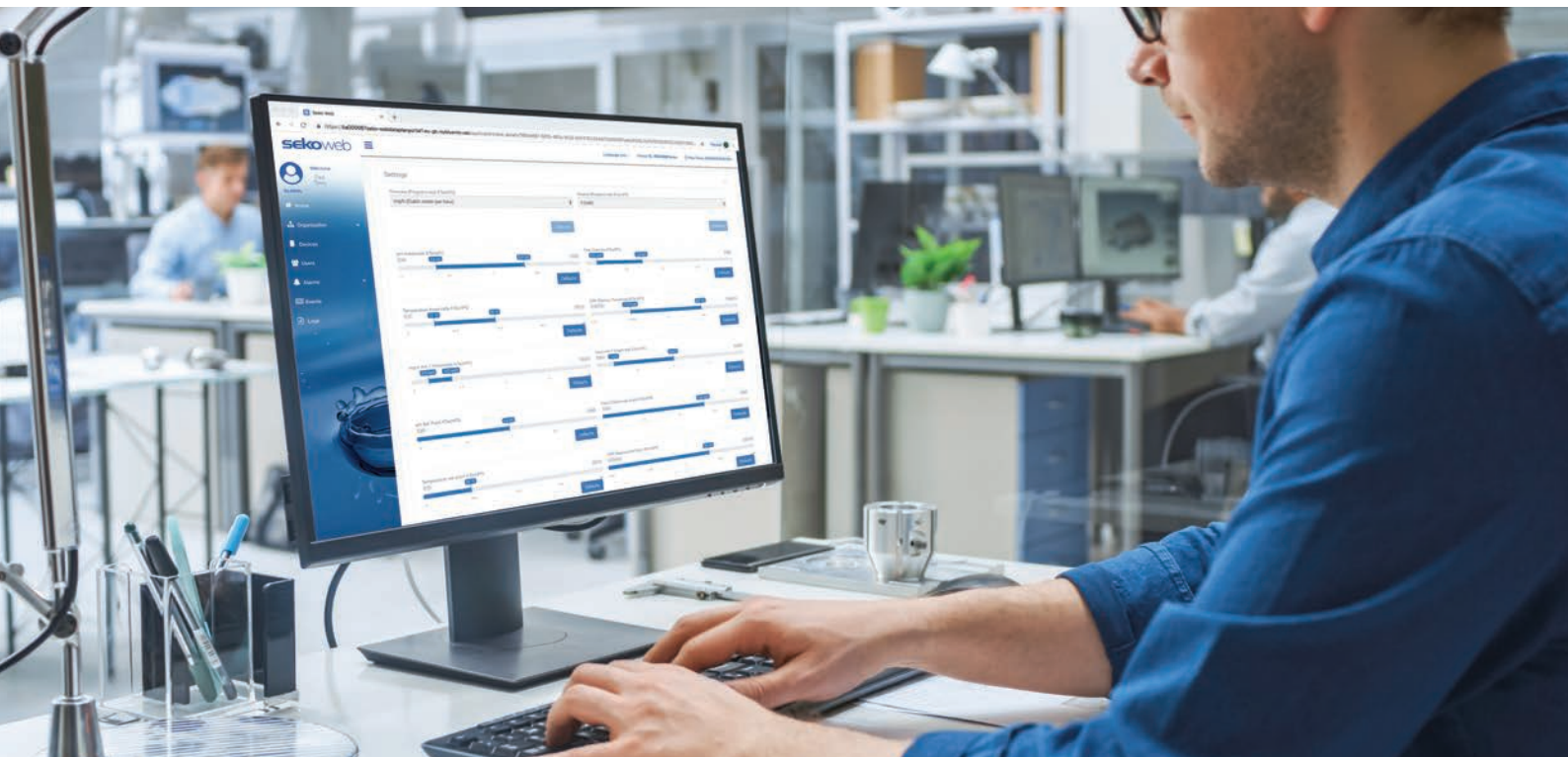

Connectivity and users



- Monitoring and complete management
- Internet portal accessible via online login or by scanning a product's QR code
- Available as an app for Android and iOS
- For plant installers, technicians and engineers

Main features



- Full access to all settings and parameters from any location
- Connect to multiple installations
- Monitor overall operating costs
- Track chemical consumption
- Adjust programmes
- Access alarm reporting
- Unrestricted data analysis
- Map geolocation

DosingPumps.it



Professional dosing pump management

By scanning a product's QR code or using their online login, dosing plant technicians can access SekoWeb, where they are able to set up and adjust water-quality parameters remotely for complete management of all their installations.

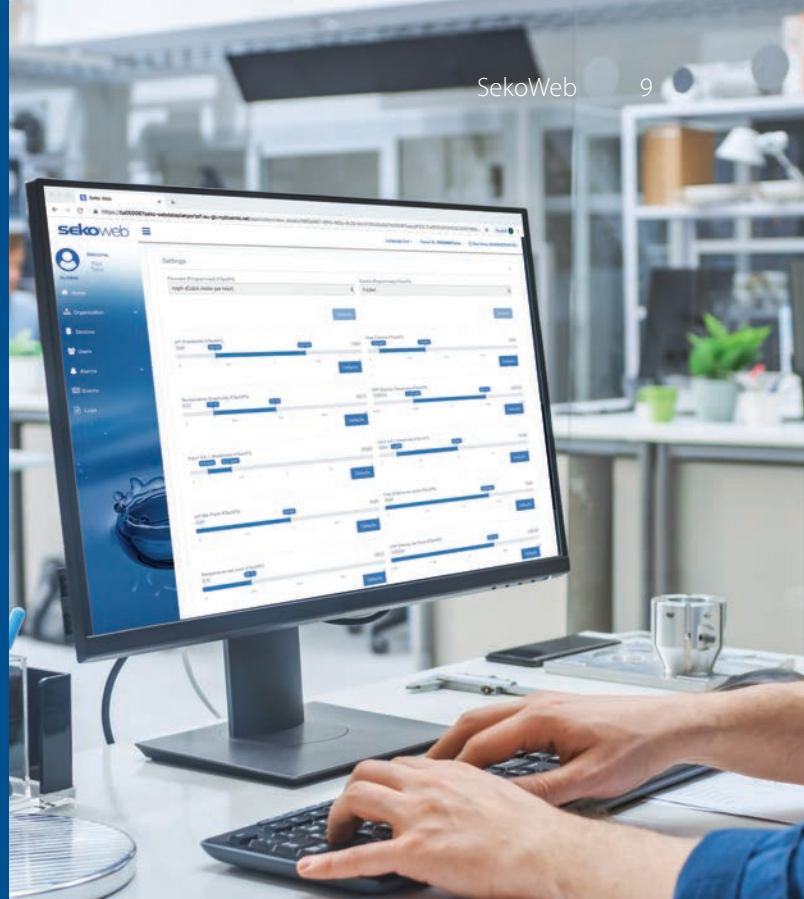

SekoWeb has been created with engineers in mind: as well as being very powerful, it requires expert technical knowledge to be used. Password protection ensures only authorized users can access the portal.

With live and historical data at their fingertips, engineers can make vital dosing adjustments 24/7 in order to maintain safe, healthy water conditions, making the portal ideal for complete management of professional installations.

Features

- Full access to parameter settings
- Adjust programmes 24/7
- Access alarm reporting
- Monitor chemical consumption
- Complete data analysis
- Map geolocation

Download on the
App Store



GET IT ON
Google Play



DosingPump.ir

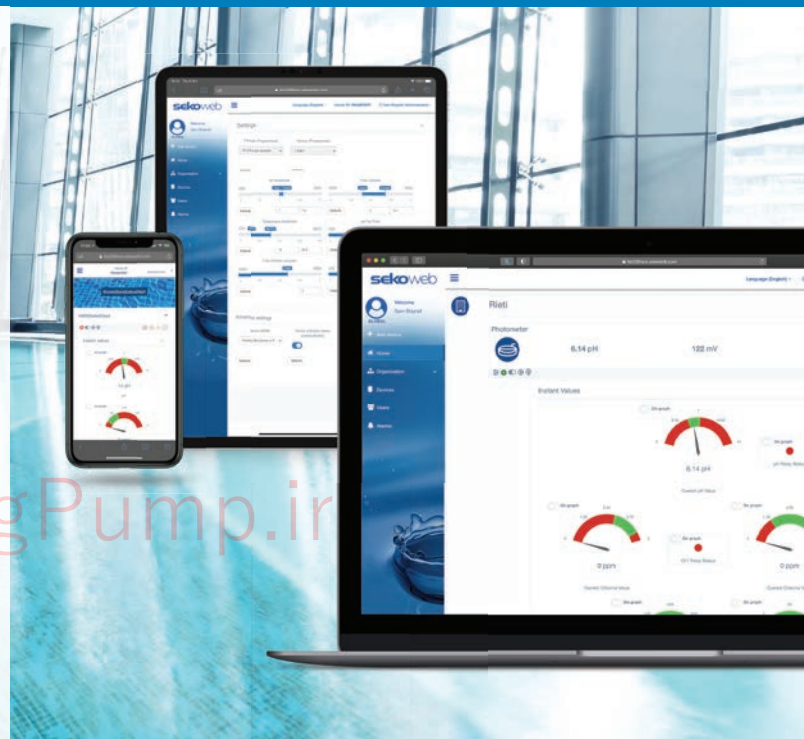



Solenoid-Driven Dosing Pumps



DosingPumps.ir

Product Overview

		Tekba-R	Tekba	Komba	Tekna	Kompact	Invikta
Performance	Flow rate range [l/h]	2.5 - 110	2.5 - 110	3 - 5	0.4 - 110	3 - 5	0.2 - 5
	Pressure [up to - bar]	20	20	10	20	10	7
Installation Mode	Base mounted	•	•	•			
	Wall mounted				•	•	•
	Bracket for alternative mounting	•	•	•	•	•	•
Power Supply	24 VAC				•	•	•
	230 VAC			•		•	•
	Wide range 100/240 VAC	•	•	•	•	•	•
User Interface	Analogue				•	•	•
	Digital	•	•	•	•	•	
Stroke Length Regulation	Mechanical	•					
Dosage Mode	Constant	•	•	•	•	•	•
	Prop. (pulse- water meter)	•	•	•	•	•	
	Prop. mA	•	•	•	•	•	
	ppm / batch	•	•		•	•	
	Weekly	•	•		•	•	
	pH / Rx		•		•	•	
ATEX	Zone 2				•		
Communication	Wi-Fi	•	•				
	Modbus	•	•		•		
Pump Head	PVDF <small>standard</small>	•	•	•	•		
	PVDF-T <small>standard</small>					•	•
	Auto degassing PVDF	•	•		•		
	SS316L	•	•		•		
O-Rings	FKM-B	•	•	•	•	•	•
	EPDM	•	•	•	•	•	•
	PTFE	•	•		•		
	FFKM	•	•	•	•		
Installation Kit	PVDF	•	•	•	•		
	PVDF-T				•	•	•

Tekba-R, Tekba & Komba

Digital base-mounted dosing pumps

Tekba-R, Tekba and Komba are professional solenoid-driven dosing pumps that share a number of key characteristics while each offering their own unique benefits for specific water-treatment applications.

These precise, robust and reliable pumps also benefit from level input on all models and standard seals in FKM-B or EPDM, with special seals available for each model.



Chemical compatibility

PVDF pump head and delivery tubes and fittings plus ceramic ball valves provide pump longevity and compatibility with all principal water-treatment applications.



Long-life diaphragm

PTFE diaphragm, guaranteed for 5 years.



Ease of installation

Pumps can be installed with the casing closed and without special tools.



Electrical safety

All electrical connections are available externally on circular IP65 connectors.

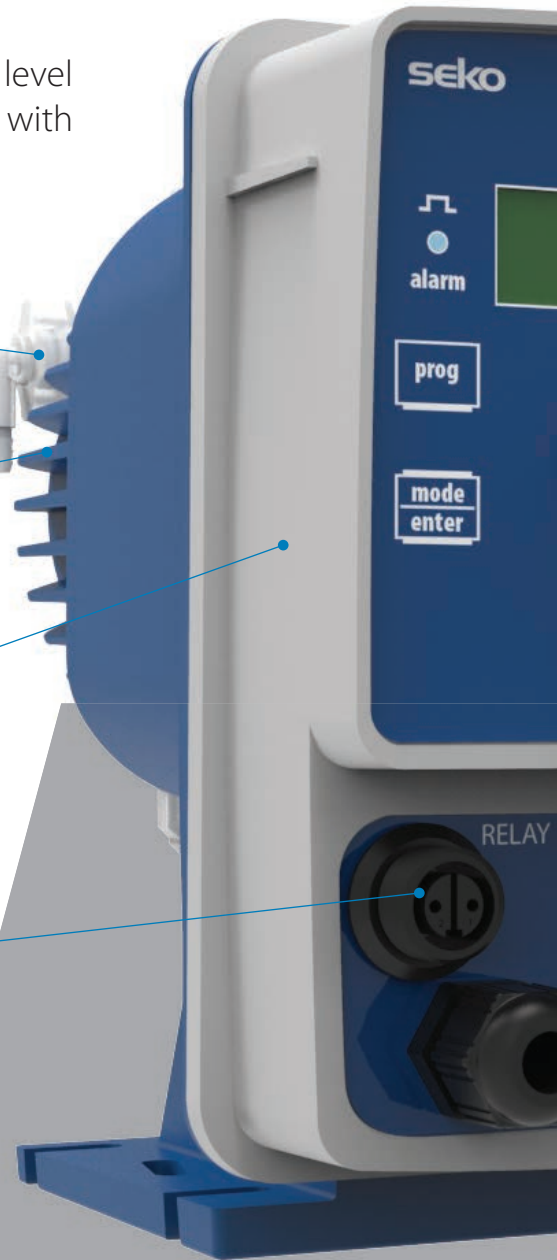

DosingPump.ir



Reliable and consistent

As well as protecting the pump itself and the environment, the driving algorithm compensates for power supply fluctuations, enabling precise and accurate dosing in any conditions.



Mechanical stroke adjustment available on Tekba-R version



Reduced energy consumption

A stabilized multi power supply (100 - 240 Vac, 50/60 Hz) comes as standard, with its solenoid-driving algorithms, patented by SEKO, helping to reduce energy consumption.



Simplified cabling

Cable connectors have internal screw terminals, facilitating a clean and professional installation with cables pre-cut to the correct size.

Applications

- Agricultural water treatment
- Food & beverage
- Industrial water treatment
- Potable water treatment
- Wastewater treatment

DosingPump.ir

Tekba-R

Solenoid-driven pumps with mechanical stroke-length regulation

Tekba-R is a range of digital solenoid-driven dosing pumps with mechanical stroke-length regulation. It represents a state-of-the-art solution for its reliability, dosing precision and ease of use and has been designed in response to positive customer feedback on the Tekna Series. The Tekba-R Series offers a modern and reliable product, a reference point in the base-mounted dosing pump sector.

- Flow rate range: 2.5 – 110 l/h, up to 20 bar
- Wetted parts: PVDF, PTFE, FFKM, EPDM, FKM-B and Ceramic

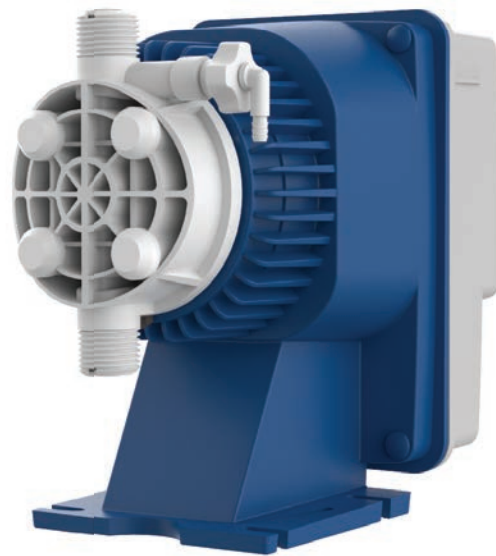

Tekba-R's unique features include a digital interface that allows programming via keyboard and display, while solenoid stroke adjustment can be performed with a mechanical knob for increased dosing precision.

Tekba-R is available in two models. The EML is a constant dosing pump with programmable flow rate, while the EMG is a multifunction pump that includes operating modes timed or proportional to an analogue 4-20mA signal, or to a digital signal such as that generated by a pulse-emitting water meter.

Tekba-R is also available with a Modbus interface, which allows the pump to be integrated into a more complex system in which other Modbus devices are already present. It's also available with a Wi-Fi interface which enables operation via the SekoWeb app or online portal.

Features

Mechanical stroke length regulation

EML: Constant dosing at the desired flow rate

EMG: Multifunction:

- 4-20mA analogue input
- Frequency input
- Remote ON / OFF input
- Directly connectable to a water meter
- Dosage in ppm
- Functions 1: N, N: 1, 1: 1
- Timed dosing

Available with special seals in PTFE or FFKM

Available with Modbus RTU RS485 port

Available with Wi-Fi interface that allows:

- Direct local connection to the pump for its programming via internal webserver
- Connection to a Wi-Fi network for remote management via the SekoWeb app or online portal

Tekba-R key code

Model									
EML Constant flow rate. Stroke length adjustable with a mechanical knob. Working frequency (strokes per minute) adjustable via digital interface. With level input.									
EMG Multifunction pump. Stroke length adjustable with a mechanical knob. Working mode to be set via its digital interface.									
Hydraulics	Pressure [bar]	Flow rate [l/h]	Capacity [cc/stroke]	Ø Hydr Connections IN / EXT. [mm]	Frequency [stroke/min]	Consumption [W]	Weight [kg]	Carton size LxWxH [mm]	
600	20	2.5	0.35	4 / 6	120	20	3.9	290 x 255 x 220	
	18	3	0.42						
	14	4.2	0.58						
	8	7	0.97						
603	12	4	0.42	4 / 6	160	20	3.4	290 x 255 x 220	
	10	5	0.52						
	8	6	0.63						
800	2	8	0.83	4 / 6	300	20	4.4	290 x 255 x 220	
	16	7	0.38						
	10	10	0.55						
	5	15	0.83						
803	1	18	1.00	8 / 10	300	40	4.4	290 x 255 x 220	
	5	20	1.11						
	4	32	1.78						
	2	62	3.44						
	0.1	110	6.11						

Stroke-length regulation				
M	Mechanical regulation			
Power supply Wide range				
N	100 - 240 Vac 50/60 Hz			
Liquid end				
H		Body	Balls	Diaphragm
A	Automatic degassing	PVDF	Ceramic	PTFE
I		SS316L	SS316L	PTFE
Installation kit				
H	PVDF			
O-Ring				
0	FKM-B			
1	EPDM			
2	PTFE			
3	FFKM			
Colour				
00	Standard	Back RAL7004	Front RAL5010	
Communication				
0	No			
W	Wi-Fi			
M	Modbus			
Customization				
0	Standard			

EMG	800	M	N	H	H	2	00	W	0
-----	-----	---	---	---	---	---	----	---	---

Tekba

Base-mounted solenoid-driven dosing pumps

Tekba is a digital base-mounted solenoid-driven dosing pump. It represents the best compromise between reliability, dosing precision and ease of use and has been designed to satisfy the needs of the market. Tekba offers the same features and functions of the Tekba-R range, except its mechanical stroke regulation but with a wider selection of models that enable the series to meet a broader range of applications.

- Flow rate range: 2.5 – 110 l/h, up to 20 bar
- Wetted parts: PVDF, PTFE, FFKM, EPDM, FKM-B and Ceramic



Alongside the constant and multifunction EML and EMG models, common to the Tekba-R range, the Tekba series includes two purely proportional models: EMM, which manages a 4-20mA input and EMC, which accepts a pulse input.

An EMR instrument-pump is also available, with an input for a pH/ORP probe. The EMG and EMR versions are also available with a Modbus communication port for integrating the pump into a more complex system, or with a Wi-Fi interface that allows the pump to be managed via SekoWeb.

Features

EML: Constant dosing at the desired flow rate

EMG: Multifunction

EMM: Proportional (4-20mA input)

EMC: Proportional (digital pulse input)

EMR: Instrument-pump with pH/ORP input

Available with special seals in PTFE or FFKM

Available with Modbus RTU RS485 port

Available with Wi-Fi interface that allows:

- Direct local connection to the pump for programming via internal webserver
- Connection to a Wi-Fi network, for remote management via the SekoWeb app or online portal

Tekba key code

Model										
EML	Constant flow rate. Flow rate adjustable via digital interface. With level input.									
EMG	Multifunction pump. Working mode to be set via its digital interface.									
EMR	Instrument-pump. Dosage in function of the measured pH or redox value. PT100 probe input also available for thermal compensation.									
EMM	Proportional dosing to an analogue signal (4-20mA).									
EMC	Proportional dosing to a digital frequency signal (pulse).									
Hydraulics		Pressure [bar]	Flow rate [l/h]	Capacity [cc/stroke]	Ø Hydr Connections IN / EXT. [mm]	Frequency [stroke/min]	Consumption [W]	Weight [kg]	Carton size LxWxH [mm]	
600		20	2.5	0.35	4 / 6	120	20	3.9	290 x 255 x 220	
		18	3	0.42						
		14	4.2	0.58						
		8	7	0.97						
603		12	4	0.42	4 / 6	160	20	3.4	290 x 255 x 220	
		10	5	0.52						
		8	6	0.63						
800		2	8	0.83	4 / 6	300	20	4.4	290 x 255 x 220	
		16	7	0.38						
		10	10	0.55						
		5	15	0.83						
803		1	18	1.00	8 / 10	300	40	4.4	290 x 255 x 220	
		5	20	1.11						
		4	32	1.78						
		2	62	3.44						
		0.1	110	6.11						
Stroke-length regulation										
N	Not available									
Power supply										
N	Wide range									
N	100 - 240 Vac 50/60 Hz									
Liquid end										
H					Body	Balls	Diaphragm			
A					PVDF	Ceramic	PTFE			
I					Automatic degassing	PVDF	Ceramic	PTFE		
I					SS316L	SS316L	PTFE			
Installation kit										
H	PVDF									
Seals										
0	FKM-B									
1	EPDM									
2	PTFE									
3	FFKM									
Colour										
00	Standard	Back	Front							
		RAL7004	RAL5010							
Communication										
0	Standard									
W	Wi-Fi									
M	Modbus RTU RS485									
Customization										
0	Standard									
EMG	800	N	N	H	H	2	00	W	0	

Komba

Compact, base-mounted, solenoid-driven dosing pumps

Komba is a compact base-mounted solenoid-driven digital dosing pump designed specifically for sites where space is at a premium but performance cannot be compromised. Komba's reliability, dosing precision, user-friendliness and ease of installation mean it represents the best solution of its kind in the market today.

- Flow rate range: 3 l/h @ 10bar; 5 l/h @ 8bar
- Wetted parts: PVDF, PTFE, FFKM, EPDM, FKM-B and Ceramic



Komba is available in four models, satisfying a broad range of installation needs.

The DML is a constant dosing pump with programmable flow rate and level input. The DMM and the DMC are proportional dosing pumps; the DMM accepts an analogue 4-20mA signal as input, while the DMC accepts a digital frequency signal, such as one generated by a pulse-emitting water meter.

Features

DML: Constant dosing at the desired flow rate

DMM: Proportional (4-20mA input)

DMC: Proportional (digital pulse input)

Available with special seals in FFKM

Komba key code

Model									
DML	Constant flow rate. Flow rate adjustable via digital interface. Level input.								
DMM	Proportional dosing to an analogue signal (4-20mA).								
DMC	Proportional dosing to a digital frequency signal (pulse).								
Hydraulics	Pressure [bar]	Flow rate [l/h]	Capacity [cc/stroke]	Ø Hydr Connections IN / EXT. [mm]	Frequency [stroke/min]	Consumption [W]	Weight [kg]	Carton size LxWxH [mm]	
200	10	3	0.31	4 / 6	160	14	2.8	290 x 215 x 195	
	8	5	0.52						
Stroke-length regulation									
N	No regulation								
Power supply									
N	Wide range 100 - 240 Vac 50/60 Hz								
Liquid end									
H				Body	Balls	Diaphragm			
				PVDF	Ceramic	PTFE			
Installation kit									
H	PVDF								
O-Rings									
0	FKM-B								
1	EPDM								
3	FFKM								
Colour									
00	Standard	Back		Front					
		RAL7004		RAL5010					
Optional									
0	Standard								
Customization									
0	Standard								
DML	200	N	N	H	H	0	00	0	0

Tekna & Kompact

Wall-mounted solenoid dosing pumps

Tekna and Kompact offer precise chemical dosing for water-treatment professionals, with multiple models serving distinct applications, from basic requirements to complex high-end processes.

Delivering consistent, repeatable results, Tekna and Kompact are the go-to solution for many potable and wastewater treatment processes, with SEKO's continuous refinement of these systems meaning they always meet the latest local and national legislation.



Quality and strength

Pump body comes in PVDF as standard.



Long-life diaphragm

PTFE diaphragm, guaranteed for 5 years.



Reliable seals

Standard seals in FKM-B or EPDM.

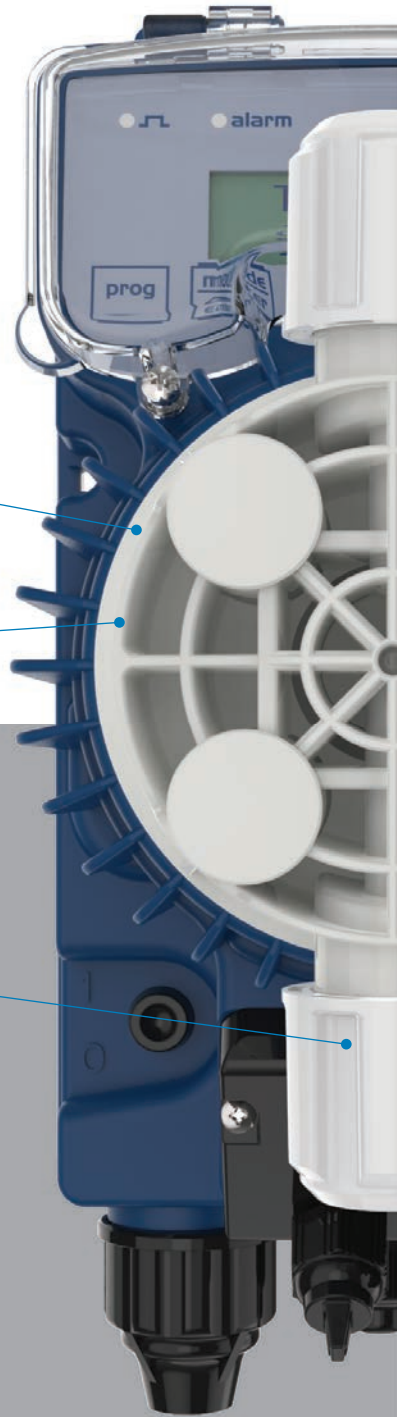

DosingPump.ir



Easy to fit

The installer-friendly bracket enables quick and simple wall mounting.



Premium seals

Available with special seals in FFKM or PTFE.



Robust and reliable

Robust and reliable for extended service life.

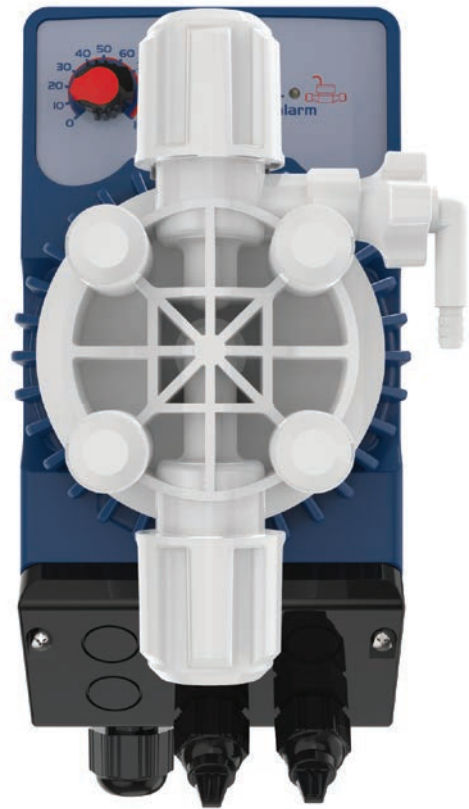

Applications

- Commercial swimming pools
- Cooling water treatment
- Food & beverage
- Industrial water treatment
- Potable water treatment
- Power generation
- Wastewater treatment

DosingPump.ir

Tekna

Wall-mounted solenoid-driven dosing pumps

Tekna is one of the most widespread, well-known and appreciated wall-mounted electromagnetic pump ranges in the world, a range that has evolved over the years by drawing upon the feedback of thousands of users across the globe. The series offers multiple models, with analogue and digital interfaces, able to satisfy every installation need and to offer a reliable and effective solution in any situation.

- Flow rate range: 0.4 – 110 l/h, up to 20 bar
- Wetted parts: PVDF, SS316L, PTFE, FFKM, EPDM, FKM-B and Ceramic
- Analogue and digital range with constant or proportional dosage



Numerous Tekna models are available, with analogic or digital interface, to satisfy almost any request from the market.

Tekna delivers reduced energy consumption thanks to an embedded stabilized multi-range power supply (100 – 240 Vac, 50/60 Hz). Thanks to the SEKO patented algorithm, the solenoid only draws the power strictly required to activate the pump, based on the actual working conditions, which improves pump efficiency and saves energy. The algorithm also compensates for any fluctuation of the power supply voltage, for giving a precise and accurate dosage in any condition.

Tekna is also available in ATEX standard-compliant versions, with constant or proportional dosage functions and a digital interface. This model comes with an SS316L stainless-steel pump body as standard.

Features

Pump body in PVDF

Kit available in PVDF or PVDF-T

Patented algorithm for driving the solenoid

AKS: Constant, with analogic interface (potentiometer)

AKL: Constant with level, analogic interface

APG: Proportional (4-20mA/pulse), analogic interface

TPG: Multifunction prop. (4-20mA/pulse), digital interface

TPR: Instrument-pump with pH/ORP input, digital interface

TCK: Weekly timed pump, digital interface

Available in ATEX-certificated models (Zone 2)

Models available with 24Vac and 12Vdc power supply

Available with special seals in PTFE or FFKM

Available with auto-degassing pump head in PVDF

Available with Modbus RTU RS485 port for:

- Integrating the pump in a more complex plant, locally managed by a PLC or an industrial PC, where other Modbus devices are already present
- Connect the pump to a KommBox or a KommSpot and, through them, to the internet for management via the SekoWeb app or online portal

DosingPumps.com

Tekna key code

Model	
AKS	Constant flow rate, without level input. Flow rate adjustable via analogic interface (potentiometer).
AKL	Constant flow rate, with level input. Flow rate adjustable via analogic interface (potentiometer).
APG	Proportional dosing to an analogue signal (4-20mA) or to digital frequency signal (pulse). With analogic interface (potentiometers).
TPG	Multifunction pump. Proportional dosing to an analogue signal (4-20mA) or to digital frequency signal (pulse). PPM mode, Timer mode, batch mode and others. Digital interface.
TPR	Instrument-pump. Dosage in accordance with the measured pH or redox value. PT100 probe input also available for thermal compensation. Digital interface.
TCK	Timed pump. Weekly programmable dosage, at the programmed flow rate, and other timed dosing modes. Digital interface.

Hydraulics	Pressure [bar]	Flow rate [l/h]	Capacity [cc/stroke]	Ø Hydr Connections IN / EXT. [mm]	Frequency [stroke/min]	Consumption [W]	Weight [kg]	Carton size LxWxH [mm]
500	20	0.4	0.06	4 / 7 delivery 4 / 6 suction	120	15	3.9	295 x 245 x 185
	16	0.8	0.11					
	10	1.2	0.17					
	6	1.5	0.21					
600	20	2.5	0.35	4 / 7 delivery 4 / 6 suction	120	20	3.9	295 x 245 x 185
	18	3	0.42					
	14	4.2	0.58					
603	12	4	0.42	4 / 6	160	20	3.4	295 x 245 x 185
	10	5	0.52					
	8	6	0.63					
	2	8	0.83					
800	16	7	0.38	4 / 6	300	20	4.4	295 x 245 x 185
	10	10	0.55					
	5	15	0.83					
803	1	18	1.00	8 / 12	300	40	4.4	295 x 245 x 185
	5	20	1.11					
	4	32	1.78					
	2	62	3.44					
	0.1	110	6.11					

Power supply	Wide range
N	100-240 Vac 50/60 Hz
0	24Vac 50/60 Hz
L	12 Vdc

Liquid end	Body	Balls	Diaphragm
H	PVDF	Ceramic	PTFE
A	Automatic degassing PVDF	Ceramic	PTFE
I	SS316L	SS316L	PTFE

Installation kit	
H	PVDF
P	PVDF-T
X	With 1.5-bar injection valve
0	Without kit (ATEX only)

Seals	
0	FKM-B
1	EPDM
2	PTFE
3	FFKM

Optional	
0	Standard
Optional/customization	
00	Standard
MO	Modbus RTU RS485
XO	ATEX certification (TPG and TCK only)

TPG 603 N H H 0 0 00



Kompact

Compact wall-mounted solenoid-driven dosing pumps

Kompact is a range of simple, reliable and compact wall-mounted solenoid-driven pumps. Designed to provide an effective response to the differing needs of the market, the series comprises multiple models, both with analogic and digital interfaces, to meet the most common installation conditions.

- Flow rate range: 3 l/h @ 10bar; 5 l/h @ 8bar
- Wetted parts: PVDF, PTFE, EPDM, FKM-B and Ceramic
- Analogue and digital range with constant or proportional dosage



Kompact has been designed as a basic range of solenoid-driven pumps for less demanding applications without compromising on robustness and reliability.

With Kompact, SEKO has struck the perfect balance between using premium components that guarantee full chemical compatibility in multiple applications while ensuring affordability for the operator.

To satisfy every installation need, the range offers five different models, for constant and proportional dosages; three with an analogic interface (potentiometer) and two with a digital interface (keyboard and 2x8 display).

Features

Pump body in PVDF

Kit available in PVDF or PVDF-T

AMS: Constant, with analogic interface (potentiometer)

AML: Constant with level, analogic interface

AMC: Proportional (pulse), analogic interface

DPT: Multifunction prop. (4-20mA/pulse), digital interface

DRP: Instrument-pump with pH/ORP input, digital interface

Available with special seals in FFKM

DosingPump.ir

Kompact key code

Model									
AMS	Constant flow rate, without level input. Flow rate adjustable via analogic interface (potentiometer).								
AML	Constant flow rate, with level input. Flow rate adjustable via analogic interface (potentiometer).								
AMC	Proportional dosing to a frequency digital signal (pulse), analogic interface.								
DPT	Multifunction pump. Proportional dosing to an analogue signal (4-20mA) or to digital frequency signal (pulse). PPM mode, Timer mode, batch mode and others. Digital interface.								
DRP	Instrument-pump. Dosage according to pH or redox value. PT100 probe input also available for thermal compensation. Digital interface.								
Hydraulics		Pressure [bar]	Flow rate [l/h]	Capacity [cc/stroke]	Ø Hydr Connections IN / EXT. [mm]	Frequency [stroke/min]	Consumption [W]	Weight [kg]	Carton size LxWxH [mm]
100		10	3	0.31	4 / 6	160	12	2.7	210 x 130 x 170
		8	5	0.52					
Power supply									
A	230 Vac 50 Hz (AMS only)								
N	100 - 240 Vac 50/60 Hz								
0	24 Vac 50/60 Hz								
Liquid end					Body	Balls	Diaphragm		
H					PVDF	Ceramic	PTFE		
Installation kit									
E	PVDF-T								
H	PVDF								
X	With 1.5-bar injection valve								
Seals									
0	FKM-B								
1	EPDM								
3	FFKM								
Optional									
00	Standard								
Customization									
0									
EMR	200	N	H	E	0	00	0		

Invikta

Compact water-treatment dosing pump

Invikta is among the most compact, easy-to-use and reliable solenoid-driven dosing pumps on the market today. Controlled via microprocessor, Invikta represents the most effective solution for many simple water-treatment applications.



Quality construction

The PVDF-T pump body has the same chemical compatibility of PVDF but at an affordable price.



Long-life diaphragm

PTFE diaphragm, guaranteed for 5 years.



Simple operation

Bracket for wall mounting.

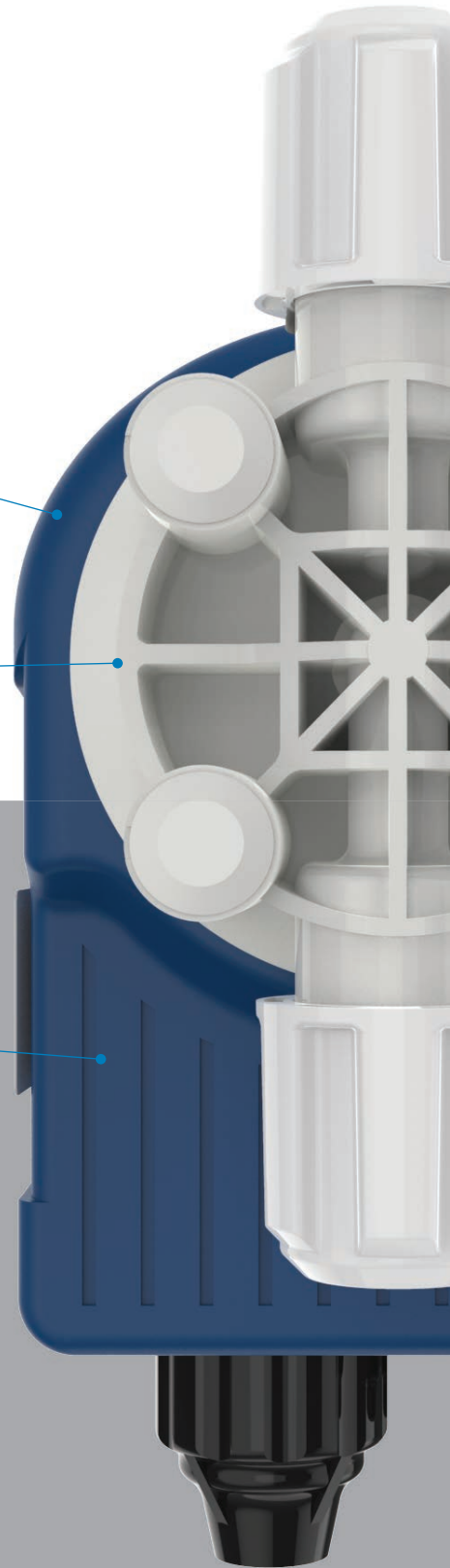

DosingPump.ir



Reliable seals

Standard seals in FKM-B or EPDM.



Priming tap

The priming tap helps to prime the pump at the first installation or when the chemical runs out.



Ease to set

Simple analogic interface: potentiometer and LED.

Applications

- Automotive water treatment
- Industrial water treatment
- Potable water treatment
- Swimming pool water treatment
- Wastewater treatment

DosingPump.ir

Invikta

The market's most user-friendly solenoid-driven dosing pumps

Controlled via microprocessor, Invikta represents the most effective solution for many simple water-treatment applications. Due to its small size, Invikta is often used as an OEM pump, integrated in more complex equipment as well as being well suited to some swimming pools and spa applications, car-washes, cooling water treatment, small reverse osmosis systems and many other situations.

- Flow rate range: 0.2 – 5 l/h, up to 7 bar
- Wetted parts: PVDF-T, PTFE, EPDM, FKM-B and ceramic



The premium components chosen for the Invikta series ensure full chemical compatibility across multiple applications and guarantee long product lifespan. Invikta's PVDF-T pump body, ceramic balls and PTFE diaphragm (guaranteed for five years) reflect SEKO's commitment to product quality, whether affordable or high-end.

Invikta's compact dimensions and a truly minimal electronic control board allow SEKO to offer a cost-effective product that represents the right solution where simple functionality is a priority.

As with all other SEKO solenoid-driven pumps, Invikta is housed within a polypropylene casing and delivers IP65 protection. This provides excellent dust and water resistance, meaning Invikta can be used safely in a multitude of environments.

Features

Pump body and fittings in PVDF-T

PTFE diaphragm, guaranteed for 5 years

Simple analogic interface: potentiometer and LED

KCS: Constant, without level, with adjustable flow rate

Standard seals in FKM-B or EPDM

Bracket for wall mounting

Bleed tap facilitates priming

KCS Low-Noise model available for spa applications

DosingPump.ir

Invikta key code

Model										
KCS Constant flow rate, without level input. Flow rate adjustable via analogic interface (potentiometer).										
Hydraulics	Pressure [bar]	Flow rate [l/h]	Capacity [cc/stroke]	Ø Hydr Connections IN / EXT. [mm]	Frequency [stroke/min]	Consumption [W]	Weight [kg]	Carton size LxWxH [mm]		
620	1	0.2	0.17	4 / 6	20	15	2.5	190 x 130 x 170	Low-noise version	
630	7	0.6	0.10	4 / 6	100	15	2.5	190 x 130 x 170	Low-flow version	
632	7	2	0.33	4 / 6	100	15	2.5	190 x 130 x 170		
633	5	5	0.52	4 / 6	160	15	2.5	190 x 130 x 170		
Power supply										
A	230 Vac 50 Hz									
N	100 - 240 Vac 50/60 Hz Wide range – Low-noise version only									
0	24Vac 50/60 Hz									
Liquid end					Body	Balls	Diaphragm	O-ring		
VF					PVDF-T	Ceramic	PTFE	FKM-B		
VE					PVDF-T	Ceramic	PTFE	EPDM		
Installation kit										
K	Standard									
D	Detergent									
R	Rinse									
S	Low-noise type - only injection valve									
Optional										
00	Standard									

KCS

630

N

VF

K

00







Motor-Driven Dosing Pumps



DosingPump.ir

Product Overview

								
		Kosmo MM2	Kosmo MM1	Spring with Elektra	Spring PS2	Spring PS1	Spring MS1	Spring MSV
Performance	Flow rate range [l/h]	80 - 2,300	9 - 530	1.5 - 1,000	2.5 - 1,000	1.5 - 304	5.5 - 1,200	10 - 120
	Pressure [up to - bar]	10	12	20	100	20	16	5
Installation Mode	On the base	•	•	•	•	•	•	•
	Bracket for base			•	•	•	•	
	Bracket for tank			•	•	•	•	
Motor	3 phase	•	•	•	•	•	•	•
	1 phase				•	•	•	•
	Servoventilated	•	•		•	•	•	•
Stroke Length Regulation	Manual	•	•	•	•	•	•	•
	Electric actuator				•	•	•	
Pump Head (FPM and EPDM seals)	PVC			•	•	•	•	
	pp			•			•	
	PVDF	•	•	•			•	•
	SS316L	•	•	•	•	•	•	•
Special Pump Head	SS316L NBR + PTFE piston seals				•			
Proportional Dosing	External signal			•				
Communication	Wi-Fi			•				
	Modbus			•				

Motor-Driven Pumps

Among SEKO's pumps, Kosmo offers the highest flow rates

A range of electric motor-driven pumps with mechanical diaphragm liquid ends and mechanical return aimed at delivering exceptional performance across a wide range of flow and pressure environments.



Ideal when you need high flow rates at medium/low discharge pressures

The Kosmo range comprises two principal models, MM1 and MM2, and is designed to be compact and robust. Kosmo offers great performance across a wide range of flow rates as low as 3.5 l/h up to 2300 l/h. This makes Kosmo ideal for low discharge pressures in applications such as water treatment, food production and clean-in-place.



Ideal for prolonged, continuous usage

As with all SEKO pumps Kosmo is designed using materials chosen for their robustness and chemical compatibility and is conceived to work for long periods of continuous operation thanks to the benefits derived from its variable eccentric system. SEKO's Kosmo PTFE diaphragm is directly linked to the mechanism's moving parts meaning Kosmo can easily deal with high suction head conditions.

All components feature permanent lubrication, using ball bearings for the principal moving parts to help prevent overheating and extend the pump's life, with the added benefit of quiet running.



A wide range of applications

Suitable for a wide range of applications including a variety of water-treatment processes, Kosmo can be effectively used in any of the following:

- Potable water treatment (injection of coagulants, flocculating agents, sodium hypochlorite, lime slurry, acid, bases, caustic soda, activated carbon and more)
- Domestic or industrial wastewater treatment, boiler feed water and cooling water
- Chemical treatment, electrolytic (electro-plating) treatments: addition of degreasing agents, cleaning agents, nickel electroplating and chemical nickel plating, copper plating and tinning



Kosmo MM2

Mechanical-return diaphragm dosing pump

- Flow rate range: 80 - 2,300 l/h, up to 10 bar
- Wetted parts: SS316L, PVDF, PTFE, FPM, EPDM and ceramic



Kosmo MM2 series pumps provide superior dosing performance for the most demanding applications. Constructed in hard-wearing metal with a cast-aluminium housing, Kosmo MM2 can handle the largest output with flow rates as high as 2,300 l/h, at pressures up to 10 bar.

As with all SEKO pumps Kosmo is designed using materials chosen for their robustness and chemical compatibility and is conceived to work for long periods of continuous operation thanks to the benefits derived from its variable eccentric system. SEKO's Kosmo PTFE diaphragm is directly linked to the mechanism's moving parts, meaning Kosmo makes use of the motor's power both in the suction and delivery phases which allows it to deal with high suction head conditions.

All components feature permanent lubrication, using ball bearings for the principal moving parts to help prevent overheating and extend pump life with the added benefit of quiet-running operation.

Specification

Model	Diameter [mm]	Stroke length [mm]	Frequency [stroke/1']	Flow rate [l/h]	Max pressure [bar]	Connections		Motor/3ph [kW/pole]	Weight [kg]	Size LxWxH [mm]
						SS316L	PVDF			
MM2F124D**C40000	124	7	43	80	10	BSPf 3/4"	BSPf 3/4"	0.55 / 4	56	700 x 500 x 750
MM2F124F**C40000			131	250						
MM2G124G**C40000	140	8	175	450	7	BSPf 1"	BSPf 1"	60		
MM2G140G**C40000			175	600						
MM2H157G**C40000	157	9	131	1,000	4	BSPf 1 1/2"	BSPf 1 1/2"	0.75 / 4		
MM2I179F**D40000	179	15	175	1,600						
MM2I179G**E40000				175	2,300			1.1 / 4	68	

Kosmo MM2 key code

Model	
M	Diaphragm Pump
Mechanism type	
M2	Mechanical return (large mechanism)
Stroke length [mm]	
F	7
G	8
H	9
I	15
Diaphragm diameter [Ømm]	
124	124
140	140
157	157
179	179
Stroke/1' (With 4-pole motor) Ratio	
D	43 32:1
E	86 32:2
F	131 32:3
G	175 32:4
Pump head	
	Body Balls Diaphragm Seat O-Ring
21	SS316L SS316L PTFE SS316L FPM
24	SS316L SS316L PTFE SS316L EPDM
41	PVDF Ceramic PTFE PVDF FPM
44	PVDF Ceramic PTFE PVDF EPDM
Motor power	
	kW Supply Size
O	Without motor
C	0.55 - 3ph 230/400 Vac 80-B5
D	0.75 - 3ph 230/400 Vac 80-B5
E	1.1 - 3ph 230/400 Vac 80-B5
Motor poles/phases	
0	Without motor
2	2 / 3
4	4 / 3
Optional	
0	Standard
I	Inverter
S	Servoventilated
X	Explosion proof
V	Explosion proof servoventilated
Customization	
000	Standard

M M2 G 124 G 24 C 4 0 000

Motor-Driven Pumps

Kosmo MM1

Mechanical-return diaphragm dosing pump

- Flow rate range: 9 - 530 l/h, up to 12 bar
- Wetted parts: SS316L, PVDF, PTFE, FPM, EPDM and ceramic



Featuring characteristics and functions very similar to those of the MM2 models, the MM1 systems of the Kosmo range have smaller dimensions and can be used effectively where the required flow rates are lower, but it is necessary to work at slightly higher pressures. In fact, these pumps can handle flow rates of up to 530 l/h and can work at pressures up to 12 bar.

These models are manufactured from materials that deliver superior robustness and chemical compatibility and are designed to operate continuously for long periods, thanks in part to the benefits of the variable eccentric system. The PTFE diaphragm is directly connected to the mechanism and this allows the pump to exploit the power of the motor both in suction and delivery phases, allowing it to work even in high suction head conditions.

All components benefit from permanent lubrication, using ball bearings for the principal moving parts that help prevent overheating and extend pump life with the added benefit of quiet running.

Specification

Model	Diameter [mm]	Stroke length [mm]	Frequency [stroke/1']	Flow rate [l/h]	Max pressure [bar]	Connections		Motor/3ph [kW/pole]	Weight [kg]	Carton size LxWxH [mm]
						SS316L	PVDF			
MM1065A**A40000	65	2	116	9	12	BSPf 1/4"	8x12 PE hose	0.25 / 4	16	450 x 300 x 550
MM1096B**A40000	96	4	78	53	10	BSPf 3/8"	DN 10			
MM1D124B**B40000	124	6.4	156	170	7	BSPf 3/4"	DN 20			
MM1D124B**B20000				340	5					
MM1E140B**B20000	140	7.4	530			BSPf 1"	DN 25	0.37 / 4	20	

Kosmo MM1 key code

Model	
M	Diaphragm pump
Mechanism type	
M1	Mechanical return (small mechanism)
Stroke length [mm]	
A	2
C	4
D	6.4
E	7.4
Diaphragm diameter [Ømm]	
065	65
096	96
124	124
140	140
Stroke/1' (With 4-pole motor) Ratio	
A	58 24:1
B	78 18:1
C	116 12:1
Pump head	
21	Body: SS316L, Balls: SS316L, Diaphragm: PTFE, Seat: SS316L, O-Ring: FPM
24	Body: SS316L, Balls: SS316L, Diaphragm: PTFE, Seat: SS316L, O-Ring: EPDM
41	Body: PVDF, Balls: Ceramic, Diaphragm: PTFE, Seat: PVDF, O-Ring: FPM
44	Body: PVDF, Balls: Ceramic, Diaphragm: PTFE, Seat: PVDF, O-Ring: EPDM
Motor power	
0	Without motor
A	0.25 - 3ph 230/400 Vac 71-B5
B	0.37 - 3ph 230/400 Vac 71-B5
Motor poles/phases	
0	Without motor
2	2 / 3
4	4 / 3
Optional	
0	Standard
I	Inverter
S	Servoventilated
Customization	
000	Standard

M M1 C 096 B 41 A 4 0 000

Spring Pumps: Motor-driven dosing pumps need to be robust, reliable and able to run without supervision

Featuring a spring return mechanism in an aluminium housing, these pumps always deliver robust, affordable and efficient power.

They offer flexibility in stroke length and motor speed which are separately controllable. Available both in plunger piston and in mechanically actuated diaphragm versions, SEKO's Spring pumps can be used almost universally in low-pressure applications with the additional benefit of being a zero-leakage solution (membrane version).

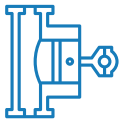

Piston options

Piston available as standard in SS316 or ceramic

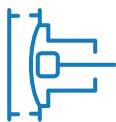

Diaphragm options

Mechanical diaphragm in PTFE

SEKO's entry-level offering in motor-driven pumps is the Spring series, a range of pumps based on the spring return principle. Three sizes of mechanism and a wide selection of models with varying performance profiles allow the user to find the appropriate solution for almost any application, offering accurate dosing under varying pressure conditions.

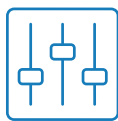

Optional extras

All models are also available in the Elektra version which integrates an inverter, with 4-20mA and pulse inputs, and menus and functions typical of proportional dosing pumps

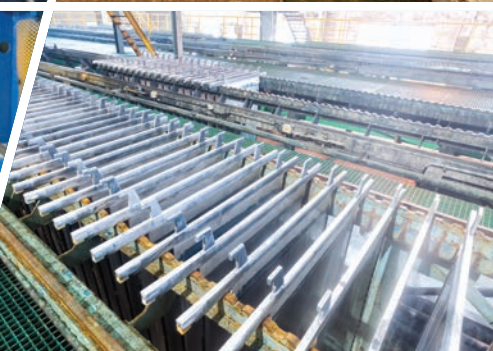

A wide range of applications

Suitable for a wide range of applications including various water-treatment processes, Spring can be effectively used in any of the following applications:

Potable water treatment (injection of coagulants, flocculating agents, sodium hypochlorite, lime slurry, acid, bases, caustic soda and activated carbon)

Domestic or industrial wastewater treatment, boiler feed water and cooling water

Chemical treatment, electrolytic (electro-plating) treatments: addition of degreasing agents, cleaning agents, nickel electroplating and chemical nickel plating, copper plating and tinning

Spring PS2

Spring-return plunger piston dosing pump

- Flow rate range: 40 - 1,000 l/h, up to 20 bar
- Wetted parts: SS316L, PVC, PTFE, FPM, EPDM and ceramic

The PS2 series of piston dosing pumps offers multiple combinations of pump head, motor power and stroke lengths that enable it to be arranged in several hydraulic configurations, making the range suitable for multiple applications.

PS2 pumps have a spring-return mechanism in a robust aluminium housing, and each model can be configured with two different stroke rates. To adjust the flow rate of the pump, the stroke length can be adjusted manually or even automatically, by using the AKTUA Kit controlled by a 4-20mA signal or by a pulse-emitting water meter.

PS2 pumps are available with a 3-phase or a single-phase electric motor, both with IP55 protection.



Specification

Model	Diameter [mm]	Stroke length [mm]	Frequency [stroke/1']	Flow rate [l/h]	Max pressure [bar]		Connections		Motor [kW/pole]	Weight [kg]		Carton size LxWxH [mm]
					SS316L	PVC	SS316L	PVC		SS316L	PVC	
PS2E025A**T4000	25	25	58	40	20	10	BSPf 3/8"	BSPf 3/8"	0.25/4 (T4)	15.5	14.5	520 x 350 x 590
PS2E025C**T4000			116	80								
PS2E030A**T4000	30		58	55	20	10	BSPf 3/8"	BSPf 3/8"	0.25/4 (T4)	15.5	14.5	
PS2E030C**T4000			116	112								
PS2E038A**U4000	38		58	90	20	10	BSPf 1/2"	BSPf 1/2"	0.37/4 (U4)	18.5	15.5	
PS2E038C**U4000			116	180								
PS2E048A**D4000	48		58	140	20	10	BSPf 1/2"	BSPf 1/2"	0.55/4 (D4)	18.5	15.5	
PS2E048C**D4000			116	284								
PS2E054A**D4000	54		58	40	15	10	BSPf 1/2"	BSPf 1/2"	0.55/4 (D4)	20.5	16.0	
PS2E054C**D4000			116	80								
PS2E064A**E4000	64		58	250	10	10	BSPf 3/4"	BSPf 3/4"	0.75/4 (E4)	21.5	16/5	
PS2E064C**E4000			116	505								
PS2E076A**E4000	76	58	365	7	7	BSPf 1"	BSPf 1"	0.75/4 (E4)	28.5	18.5		
PS2E076C**E4000		116	730									
PS2E089A**E4000	89	58	495	5	5	BSPf 1"	BSPf 1"	0.75/4 (E4)	30.5	19.0		
PS2E089C**E4000		116	1,000									

Spring PS2 key code

Model									
P	Piston pump								
Mechanism type									
S2	S2 Spring Mechanism								
Stroke length [mm]									
E	25								
Piston diameter [Ømm]									
025	25								
030	30								
038	38								
048	48								
054	54								
064	64								
076	76								
089	89								
Stroke/1'		Ratio							
A	58	24:1							
C	116	12:1							
Pump head		Body	Balls	Piston	Seat	Sealings			
21	SS316L	SS316L	SS316L	SS316L	SS316L	FPM			
24	SS316L	SS316L	SS316L	SS316L	SS316L	EPDM			
31	PVC	Ceramic	Ceramic	PTFE	PTFE	FPM			
34	PVC	Ceramic	Ceramic	PTFE	PTFE	EPDM			
Motor type		kW	Supply		Size				
S0	Without motor								
T4	0.25 - 3ph	230/400 Vac 50/60 Hz		71-B5					
U4	0.37 - 3ph	230/400 Vac 50/60 Hz		71-B5					
D4	0.55 - 3ph	230/400 Vac 50/60 Hz		80-B14					
E4	0.75 - 3ph	230/400 Vac 50/60 Hz		80-B14					
Z4	0.37 - 1ph	230 Vac 50 Hz		71-B5					
L4	0.55 - 1ph	230 Vac 50 Hz		80-B14					
M4	0.75 - 1ph	230 Vac 50 Hz		80-B14					
N4	1.1 - 1ph	230 Vac 50 Hz		71-B14		With breaker torque			
Stroke regulation									
0	Manual with adjustment knob								
L	Automatic, with linear actuator of AKTUA series								
Customization									
0	Standard								
H	High pressure								
Optional									
0	Standard								
2	(S0 - without motor) + adapter kit								

P S2 E 038 C 21 U4 0 0 0

Motor-Driven Pumps

Spring PS1

Spring-return plunger piston dosing pump

- Flow rate range: 1.5 - 304 l/h, up to 20 bar
- Wetted parts: SS316L, PVC, PTFE, FPM, EPDM and Ceramic

The PS1 series is designed for applications that require lower flow rates than the PS2 series while offering multiple combinations of pump head, motor power and piston stroke length. This achieves multiple hydraulic characteristics for adapting to a large number of applications.

Like PS2, each model can be configured with two different stroke rates and is available with 3-phase or single-phase motors, both with IP55 protection.

Versions with a 12 Vdc motor are available that achieve flow rates between 34 and 350 l/h at pressure up to 20 bar.



Specification

Model	Diameter [mm]	Stroke length [mm]	Frequency [stroke/1]	Flow rate [l/h]	Max pressure [bar]		Connections		Motor [kW/pole]	Weight [kg]		Carton size LxWxH [mm]
					SS316L	PVC	SS316L	PVC		SS316L	PVC	
PS1D006A**A4000	6	25	58	1.5	20	10	BSPf 1/4"	BSPf 1/4"	0.18/4 (A4)	10.0	8.5	435 x 295 x 520
PS1D006C**A4000			116	3								
PS1D011A**A4000	11		58	5	20	10	BSPf 1/4"	BSPf 1/4"	0.18/4 (A4)	10.0	8.5	
PS1D011C**A4000			116	10								
PS1D017A**A4000	17		58	11	20	10	BSPf 3/8"	BSPf 3/8"	0.18/4 (A4)	10.0	8.5	
PS1D017C**A4000			116	22								
PS1D025A**A4000	25		58	25	20	10	BSPf 3/8"	BSPf 3/8"	0.18/4 (A4)	10.0	8.5	
PS1D025C**A4000			116	50								
PS1D030A**B4000	30		58	35	20	10	BSPf 3/8"	BSPf 3/8"	0.25/4 (B4)	11.5	10.0	
PS1D030C**B4000			116	70								
PS1D038A**B4000	38		58	55	17	10	BSPf 3/8"	BSPf 3/8"	0.25/4 (B4)	13.0	10.0	
PS1D038C**B4000			116	110								
PS1D048A**B4000	48	58	85	10	10	BSPf 1/2"	BSPf 1/2"	0.25/4 (B4)	13.0	10.0		
PS1D048C**B4000		116	170									
PS1D054A**B4000	54	58	110	8	8	BSPf 1/2"	BSPf 1/2"	0.25/4 (B4)	15.0	10.5		
PS1D054C**B4000		116	220									
PS1D064A**B4000	64	58	152	6	4	BSPf 3/4"	BSPf 3/4"	0.25/4 (B4)	16.0	15		
PS1D064C**B4000		116	304									

Spring PS1 key code

Model									
P	Piston pump								
Mechanism type									
S1	S1 Spring Mechanism								
Stroke length [mm]									
D	15								
Piston diameter [Ømm]									
006	6								
011	11								
017	17								
025	25								
030	30								
038	38								
048	48								
054	54								
064	64								
Stroke/1'		Ratio							
A	58	24:1							
C	116	12:1							
Pump head									
Pump head	Body	Balls	Piston	Seat	Sealings				
21	SS316L	SS316L	SS316L	SS316L	FPM				
24	SS316L	SS316L	SS316L	SS316L	EPDM				
31	PVC	Ceramic	PTFE	PTFE	FPM				
34	PVC	Ceramic	PTFE	PTFE	EPDM				
Motor type		kW	Supply		Size				
S0		Without motor							
A4	0.18 - 3ph	230/400 Vac 50/60 Hz		63-B14					
B4	0.25 - 3ph	230/400 Vac 50/60 Hz		71-B14					
H4	0.25 - 1ph	230 Vac 50 Hz		71-B14					
I4	0.37 - 1ph	230 Vac 50 Hz		71-B14					
Stroke regulation									
0	Manual with adjustment knob								
L	Automatic with linear aktuator of AKTUA series								
Customization									
0	Standard								
H	High pressure								
Optional									
0	Standard								
2	(S0 - without motor) + adapter kit								
P	S1	D	011	C	31	A4	L	0	0

Motor-Driven Pumps

Spring MS1

Spring-return mechanical diaphragm dosing pump

- Flow rate range: 5.5 - 500 l/h, up to 16 bar
- Wetted parts: SS316L, PVC, PP, PVDF, PTFE, FPM, EPDM and ceramic

The MS1 series offers multiple combinations of pump head motors, stroke lengths and materials that allows operators the chance to select the optimal combination appropriate to the specific application in hand.

Being membrane pumps, they represent an absolutely safe and leak-free solution to be used wherever chemical leaks, that are typical of plunger piston pumps, are not acceptable.

To change the flow rate of the pump, the stroke length can be adjusted manually with a knob or even automatically by using the AKTUA kit controlled by a 4-20mA signal or by a pulse emitter water meter.

Spring MS1 pumps can be supplied with a single or three-phase electric motor with IP55 protection, as well as with a DC motor working at 12 Vdc range that allows the pump to achieve flow rates between 23 and 620 l/h at pressure up to 16 bar..



Specification

Model	Diameter [mm]	Stroke length [mm]	Frequency [stroke/1']	Flow rate [l/h]	Max pressure [bar]			Connections		Motor [kW/pole]	Weight [kg]		Carton size LxWxH [mm]
					SS316L	PP/PVC	PVDF	SS316L	Other		SS316L	Other	
MS1A064A**A4000	64	2	58	5.5	16	16	16	BSPf 1/4"	BSPf 1/4"	0.18/4 (A4)	10.5	8.5	520 x 350 x 590
MS1A064B**A4000			78	8									
MS1A064C**A4000			116	11									
MS1A094A**A4000	94	2	58	20	16	16	16	BSPf 3/8"	BSPf 1/4"	0.18/4 (A4)	11.0	8.5	
MS1A094B**A4000			78	26									
MS1A094C**A4000			116	40									
MS1B108A**A4000	108	4	58	60	10	10	10	BSPf 3/8"	BSPf 3/8"	0.18/4 (A4)	13.5	10.0	
MS1B108B**A4000			78	80									
MS1B108C**A4000			116	120									
MS1C138A**C4000	138	6	58	155	7	7	7	BSPf 3/4"	BSPf 3/4"	0.37/4 (C4)	18.5	12.5	
MS1C138B**C4000			78	220									
MS1C138C**C4000			116	310									
MS1C165A**C4000	165	6	58	230	5	5	5	BSPf 1"	BSPf 1"	0.37/4 (C4)	22.0	13.5	
MS1C165B**C4000			78	330									
MS1C165C**C4000			116	500									

Spring MS1 key code

Model									
M	Spring-return diaphragm pump								
Mechanism type									
S1	S1 - membrane								
Stroke length [mm]									
A	2								
B	4								
C	6								
Diaphragm diameter [Ømm]									
064	64								
094	94								
108	108								
138	138								
165	165								
Stroke/1'									
A	58	Ratio 24:1							
B	78	Ratio 18:1							
C	116	Ratio 12:1							
Pump head									
	Body	Balls	Diaphragm	Seat	O-Ring				
21	SS316L	SS316L	PTFE	SS316L	FPM				
24	SS316L	SS316L	PTFE	SS316L	EPDM				
31	PVC	Ceramic	PTFE	PTFE	FPM				
34	PVC	Ceramic	PTFE	PTFE	EPDM				
41	PVDF	Ceramic	PTFE	PTFE	FPM				
44	PVDF	Ceramic	PTFE	PTFE	EPDM				
51	PP	Ceramic	PTFE	PTFE	FPM				
54	PP	Ceramic	PTFE	PTFE	EPDM				
Motor type									
	kW	Supply	Size						
S0	Without motor								
A4	0.18 - 3ph	230/400 Vac 50/60 Hz		63-B14					
C4	0.37 - 3ph	230/400 Vac 50/60 Hz		71-B14					
H4	0.25 - 1ph	230 Vac 50 Hz		71-B14					
L4	0.55 - 1ph	230 Vac 50 Hz		80-B14					
Stroke regulation									
0	Manual with adjustment knob								
L	Automatic with linear aktuator of AKTUA series								
Customization									
0	Standard								
H	High pressure								
Optional									
0	Standard								
2	(S0 - without motor) + adapter kit								
M	S1	B	094	A	S1	C4	0	0	0

Motor-Driven Pumps

Spring MSV

Spring-return diaphragm dosing pump

- Flow rate range: 10 - 120 l/h, up to 5 bar
- Wetted parts: SS316L, PVDF, PTFE, FPM, EPDM and ceramic

MSV pumps are the latest addition to the Spring range. These diaphragm dosing pumps are designed to ensure reliable and effective long-term dosing of chemicals at an affordable cost. They feature motorized mechanisms with high-performance, high-efficiency motors, mounted vertically over their PP casing to save space, especially where pumps are installed adjacent to one another.

Thanks to its double-camshaft mechanical structure, the pump offers high levels of stability while maintaining quiet operation and exceptionally accurate flow rates.

Adaptable to a wide range of uses, Spring MSV stands as an excellent compromise between cost and a high dosing accuracy across a wide variety of liquids, sludge and chemicals.



Specification

Model	Diameter [mm]	Stroke length [mm]	Frequency [stroke/1']	Flow rate [l/h]	Max pressure [bar]		Connections		Motor [kW/pole]	Weight [kg]	Carton size LxWxH [mm]
					SS316L	PVDF	SS316L	PVDF			
MSV070P**XD000	70	4.2	26	10	5	5	BSPF 3/8"	8x12	0.06/4 (XD)	9.5	370 x 280 x 470
MSV070Q**XD000			43	20							
MSV070N**XD000			86	40							
MSV070M**XD000			130	60							
MSV070R**XD000		5	144	90							
MSV070R**XD000		6.8	144	120	3	3					

Spring MSV key code

Model	
M	Membrane pump
Mechanism type	
SV	SV membrane
Stroke length [mm]	
I	4.2
F	5
H	6.8
Diaphragm diameter [Ømm]	
070	70
Stroke/1'	
M	130
N	86
O	43
P	26
R	144
Pump head	
21	SS316L SS316L PTFE FPM
24	SS316L SS316L PTFE EPDM
41	PVDF Ceramic PTFE FPM
44	PVDF Ceramic PTFE EPDM
Motor type	
XT	0.06 - 3ph 230/400 Vac 50/60 Hz
XD	0.06 - 1ph 230 Vac 50 Hz
Stroke regulation	
0	Manual with adjustment knob
Customization	
0	Standard
Optional	
0	Standard

M	SV	I	070	N	21	XD	0	0	0
---	----	---	-----	---	----	----	---	---	---

Motor-Driven Pumps

Spring with Elektra

Spring pumps with electronic control for proportional dosing

SEKO brings connectivity to mechanical dosing

SEKO's latest product development extends the modern benefits of proportional dosing and remote connectivity to the world of mechanical dosing pumps

Elektra builds on the SEKO Spring range of motor-driven pumps which have long been recognized for their affordability, low total cost of operation and ease of maintenance.

To these well-known features, Elektra adds all the advantages offered by the possibility of linking the pump dosage to parameters detected in the field, such as a flow rate or a chemical measurement converted into a 4-20 mA signal. In addition, Elektra allows the user to remotely monitor, manage and programme their pump via the internet from any location for a new standard in operational efficiency.



Key Features

Digital control

Multiple operating modes – timed, batch, manual, proportional from analogue or digital signals: 1:N, N:1

Intelligent graphic display – shows red, yellow or green backlight, according to the current operating function

Electronic control unit interface **can be fixed in multiple positions** to facilitate operation/installation

IoT connection

Local or remote programming and monitoring of the pump via any internet-connected device including smartphone, tablet or PC

Wireless local connection to the pump is possible even if there is no Wi-Fi at the installation site

Data on demand grants secure remote data management and programming of the pump via the SekoWeb portal or app, from any location worldwide

Real-time and historic data available 24/7 directly to any smart device or PC, including alarms to help drive **effective maintenance planning** and rapid technical intervention

All the advantages of the Spring series

SEKO's ultra-reliable **Spring range** is available in a broad range of flow rates, including high flow rate up to 1,000 l/h at up to 20 bar

Wide range of applications - suitable for high-viscosity chemical applications

Exceptionally low operating costs due to the outstanding ease of programming coupled with low maintenance requirement

Energy-efficient motors plus a wide range of materials available for superior chemical compatibility

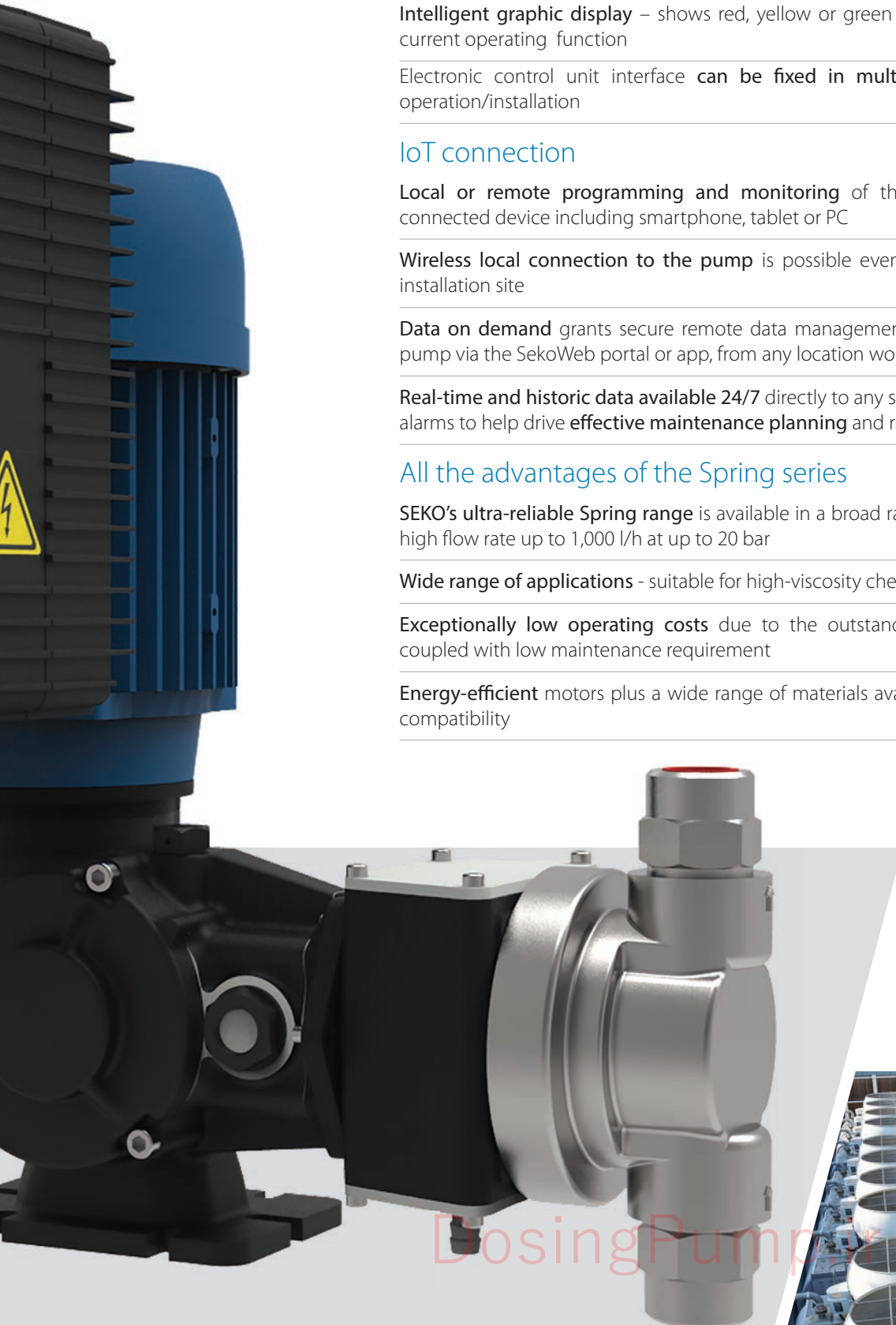

Spring with Elektra

Motor-driven pumps with spring return, electronic control and IoT



Smart graphic display

Offers not only a graphic intuitive interface, but also changes colour according to operating function.

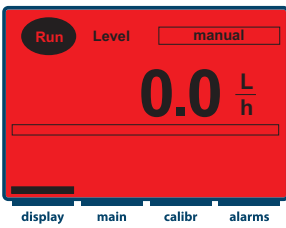

Red - shows alarm mode

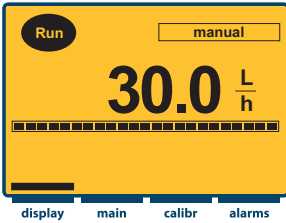

Yellow - shows the control unit is connecting to a smart device

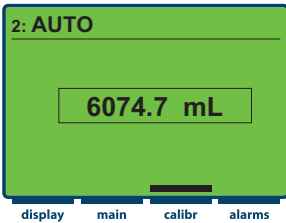

Green - shows after the successful completion of a calibration process

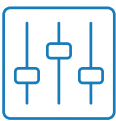
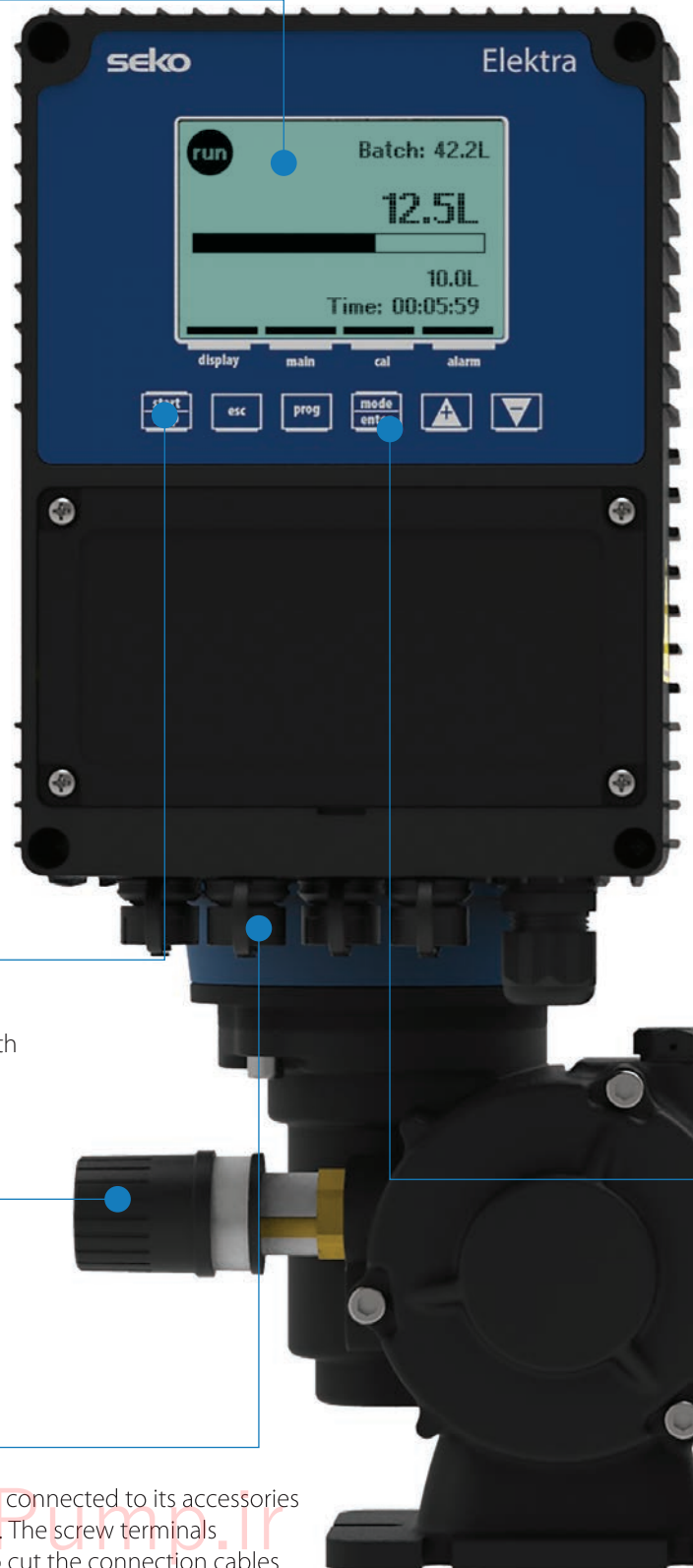

Simple fast programming

Elektra's controller allows quick and easy programming from any smart device or laptop, both remotely as well as from the display.



Manual adjustment of stroke length

Provides the ultimate in accuracy when combined with the digital dosing of Elektra's controller.



External connectors

Elektra's external connectors allow the pump to be connected to its accessories and signals from the field without opening its case. The screw terminals available in the plugs supplied allow technicians to cut the connection cables to the right length, directly in the field, and to make clean installations without the need for special tools.

DosingPump.ir

Spring with Elektra technical features

Like all Spring pumps, those equipped with Elektra are based on a spring-return mechanism housed in a sturdy aluminium case, and always provide robust, and effective power. Elektra enhances these benefits by allowing users to link the dosage to signals from the field, and to monitor and to programme the pump both locally and via the internet through any smart device or PC.

Hydraulic characteristics

Model	Flow rate [l/h]	Max pressure [bar]	Frequency [stroke/1']	Stroke length [mm]	Diaphragm diameter [mm]	Ingress protection rating
MS1 A/B/C Diaphragm pump	up to 500	up to 16	1 - 116	2 - 4 - 6	up to 165	IP55
PS1 D Piston pump	up to 304	up to 20	1 - 116	15	up to 64	IP55
PS2 E Piston pump	up to 1,000	up to 20	1 - 116	25	up to 89	IP55

Spring with Elektra key code

Motor type	kW	Size
AE	0.18 - 3ph	63-B14
BE	0.25 - 3ph	71-B14
CE	0.37 - 3ph	71-B14
DE	0.55 - 3ph	80-B14
EE	0.75 - 3ph	80-B14
TE	0.25 - 3ph	71-B5
UE	0.37- 3ph	71-B5

Optional
N Elektra - Wi-Fi connection

M S1 B 094 A S1 CE 0 0 N

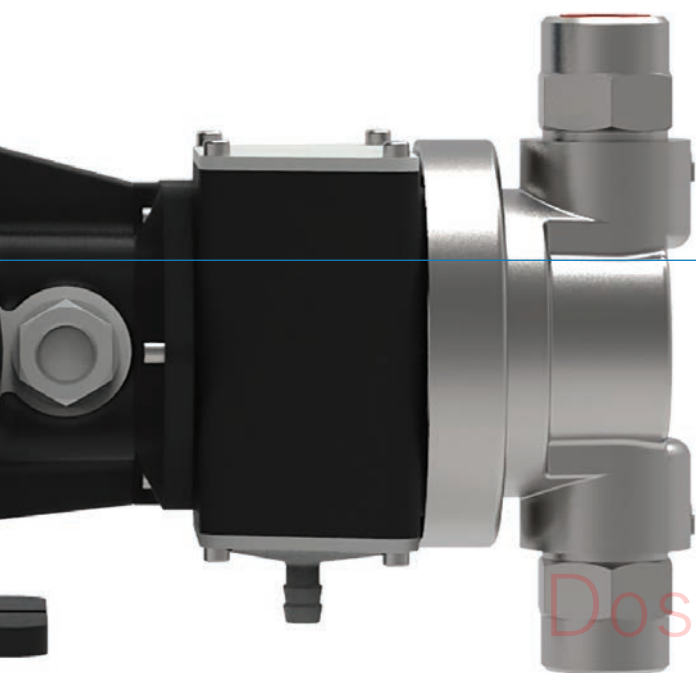

Multiple operating modes

Manual • Batch • Timed • Analogue mA • Analogue V • ppm • Pulse, digital signals

DosingPump.ir

Spring with Elektra

Motor-driven pumps with spring return, electronic control and IoT

Data on Demand

In a world that is increasingly connected, Elektra brings the benefits of **data on demand**, essential to running an efficient operation across potentially complex installations. Designed to manage operating costs of plants and installations that are continuously under financial pressure, Elektra helps **improve cost management and provides peace of mind** driven by the knowledge of consistently-precise dosing and control.

Direct connection

Even if there is no Wi-Fi network at the installation site, the technician present can connect directly with their smartphone, tablet or PC to Elektra's built-in Wi-Fi hub in order to programme the pump and check its status.

Remote connection, via the internet

Where there is a Wi-Fi network, Elektra can use the same communication module integrated in its controller to connect to the internet and exchange data with the cloud, thus allowing the pump to be managed remotely from anywhere in the world, through the portal or the SekoWeb app. Qualified technicians will therefore be able to quickly obtain historical and realtime data on the operation of the pump and be notified in the event of alarms or warnings generated by the system. This allows scheduled maintenance to be planned and reported anomalies to be actioned immediately by reprogramming from remote the dosing parameters of the pump.



Modbus RTU over RS485 serial port

Modbus standard protocol means cross-device connection and communication, allowing the user to create a wired network of standard Modbus devices. Elektra can become part of bigger plant, made of several industrial devices, all controlled by a local controller such as a PC or PLC.



Wi-Fi for a direct connection and for connecting to the internet

Elektra's integrated Wi-Fi interface allows both local direct connection to the pump from any smart device, and the connection of the pump to a Wi-Fi network, so making the pump able to exchange data on the cloud and to be monitored and programmed remotely via the internet, through the SekoWeb portal or app.



DosingPump.ir

Elektra web interface

Whether you are operating locally or remotely, the Elektra web interface provides the operator with:

Instant values: displays overview of the real-time status of the system including pump operating mode, pump status and alarm status.

Graphs and levels: displays the time graphs of the several pump parameters chosen for monitoring by the user.

Alarms: displays the active alarms. If the pump has been registered in the portal and is being accessed through SekoWeb, it is possible to view the log of all the received alarms with date, time and type.

General settings: a section where the user can set the operating mode of the pump and adjust dosing parameters.

Statistics/counters: provides an overview of the statistics of the system under control.

Advanced settings: available only to users with appropriate permissions, this allows them to set other advanced device parameters and to stop, start and pause the pump remotely.

When accessing the local pages of the internal webserver, further sections are available for updating pump firmware and setting network parameters to connect the device to the internet.

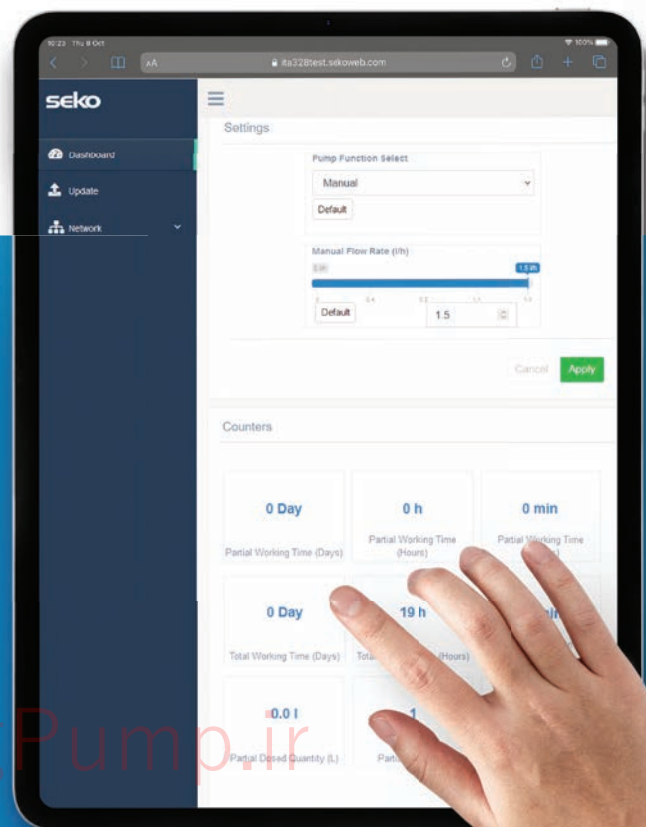

DosingPump.ir

Spring PS2 HP

Spring plunger piston-return dosing pump for high pressure

- Flow rate range: 2.5 - 12 l/h, up to 100 bar
- Wetted parts: SS316L, PTFE, NBR

The PS2 series of high-pressure piston dosing pumps can adapt to a large number of applications. Like other variants in the Spring pump series, PS2-HP has a spring-return mechanism in a sturdy aluminium housing but is equipped with special pump bodies, expressly recommended for high-pressure applications that allow this range to dose with backpressures up to 100 bar.

This model has two stroke rates. Stroke lengths can be set manually with a knob, or automatically, by using the AKTUA Kit, which can adjust the dosage proportionally to a 4-20mA or a pulse signal. To achieve the given performance, these pumps need to be actuated by a powerful 3-phase motor, provided with an IP55 protection classification.

Spring PS2 HP has been designed for use in applications requiring an economic and practical solution for dosing small amounts of product at high pressure, up to 100 bar: in a boiler, for example.



Specification

Model	Piston Diameter [mm]	Stroke length [mm]	Frequency [stroke/1]	Flow rate [l/h]	Max pressure [bar]	Connections	Motor [kW/pole]	Weight [kg]	Carton size LxWxH [mm]
PS3E006A20D4000	6	25	58	2.5	100	BSPm 1/4"	0.55/4 (D4)	10	435 x 295 x 520
PS3E006C20D4000			116	5					
PS3E010A20D4000	10		58	6					
PS3E010C20D4000			116	12					

Spring PS2 HP key code

Model									
P	Piston pump								
Mechanism type									
S2	S2 Piston								
Stroke length [mm]									
E	25								
Piston diameter [Ømm]									
006	6								
010	10								
Stroke/1'		Ratio							
A	58	24:1							
C	116	12:1							
Pump head									
20	Head	Piston	Valves	Seat valves	Seal valves	Piston seal			
	SS316L	SS316L	SS316L	SS316L	PTFE	NBR+PTFE			
Motor type		kW		Supply		Size			
S0	Without motor								
D4	0.55 - 3ph	230/400 Vac 50/60 Hz		80-B14					
Stroke regulation									
0	Manual with adjustment knob								
L	Automatic with linear aktuator of AKTUA series								
Customization									
H	High pressure								
Optional									
0	Standard								
P	S2	E	010	C	20	D4	0	H	0

Motor-Driven Pumps

Spring MS1 AVS

Spring-return diaphragm pump with Assisted Vacuum System®

- Flow rate range: 450 - 1,200 l/h, up to 4.5 bar
- Wetted parts: SS316L, PVC, PP, PVDF, PTFE, FPM, EPDM and ceramic

The AVS (Assisted Vacuum System®) helps overcome the typical functional limitations of pumps with a spring return. The increase in performance is made possible thanks to a high number of strokes/min without compromising diaphragm lifespan.

This means that Spring MS1 AVS can reach a flow rate of 1,200 l/h whilst keeping noise and mechanical stress at a reduced level. Each model can be configured with two different stroke rates and can be supplied with a single or three-phase 2-pole electric motor with IP55 protection.



Specification

Model	Diameter [mm]	Stroke length [mm]	Frequency [stroke/1']	Flow rate [l/h]	Max pressure [bar]	Connections	Motor [kW/pole]	Weight [kg]		Carton size LxWxH [mm]
								SS316L	Other	
MS1C138H**W2000	138	6	156	450	4.5	BSPF 1*	0.55/2 (W2)	18.5	12.5	520 x 350 x 590
MS1C138Q**W2000			232	750				18.5	12.5	
MS1C165Q**W2000	165	232	1,200	2	22.0			13.5		

Spring MS1 AVS key code

Model						
M	Membrane pump					
Mechanism type						
S1	S1 Spring membrane					
Stroke length [mm]						
C	6					
Diaphragm diameter [Ømm]						
138	138					
165	165					
Stroke/1'						
H	156	18:1				
W	232	12:1				
Pump head						
	Body	Balls	Diaphragm	Seat	O-Ring	
21	SS316L	SS316L	PTFE	SS316L	FPM	
24	SS316L	SS316L	PTFE	SS316L	EPDM	
31	PVC	Ceramic	PTFE	PTFE	FPM	
34	PVC	Ceramic	PTFE	PTFE	EPDM	
41	PVDF	Ceramic	PTFE	PTFE	FPM	
44	PVDF	Ceramic	PTFE	PTFE	EPDM	
51	PP	Ceramic	PTFE	PTFE	FPM	
54	PP	Ceramic	PTFE	PTFE	EPDM	
Motor type						
	kW	Supply			Size	
S0		Without motor				
W2	0.55 - 3ph	230/400 Vac 50/60 Hz			71-B14	
Y2	0.55 - 1ph	230 Vac 50 Hz			71-B14	
Stroke regulation						
0	Manual with adjustment knob					
L	Automatic Linear Aktuator AKTUA Series					
Customization						
0	Standard					
Optional						
A	AVS - Assisted Vacuum System*					

M S1 C 165 W 51 W2 0 0 A

Motor-Driven Pumps



Peristaltic dosing pumps for water treatment



DosingPump.ir

Product Overview

		Kronos 65	Kronos 50	Kronos 20
				
Features	IP65 enclosure box	•	•	•
	LCD display	16x2	16x2	8x2
	Motor	Stepper	Stepper	Brushed DC
	Tube breakage detection system	•	•	•
	pH / ORP input			•
	Installation kit, Ceramic foot filter • FPM injection valve • PVC suction tube • PE delivery tube		•	•
Model Type	HX: with pH / ORP • Built-in controller meter		•	•
	FM: proportional: • Digital frequency signal (pulse)	•	•	
	Analogic signal (4-20mA) FF: proportional full: • Digital frequency signal (pulse) • Analogic signal (4-20mA) • Voltage signal (0-10V)	•	•	
	EC: for cooling towers • Conductivity input for drain control • Dosage proportional to water flow • Specific Cooling Tower menu		•	
	Santoprene	•	•	•
Tube	SekoExtra		•	
	SekoMed		•	
	SekoFort		•	
	HP-San		•	

Kronos Series

Multi-application peristaltic pumps

Kronos is a range of durable and robust peristaltic pumps suited to multiple applications within the cleaning and hygiene and water-treatment industries. Easy to install and requiring minimal maintenance, the whole Kronos range is designed to deliver a “fit and forget” solution that provides convenience and reliability for busy operators.



Stepper motor*

Unprecedented dosing precision down to 0.01% of maximum flow



Simplified maintenance

Designed to ensure main connections remain fixed during servicing



Advanced motor control

Eliminates vibration and friction for quiet running and extended lifespan

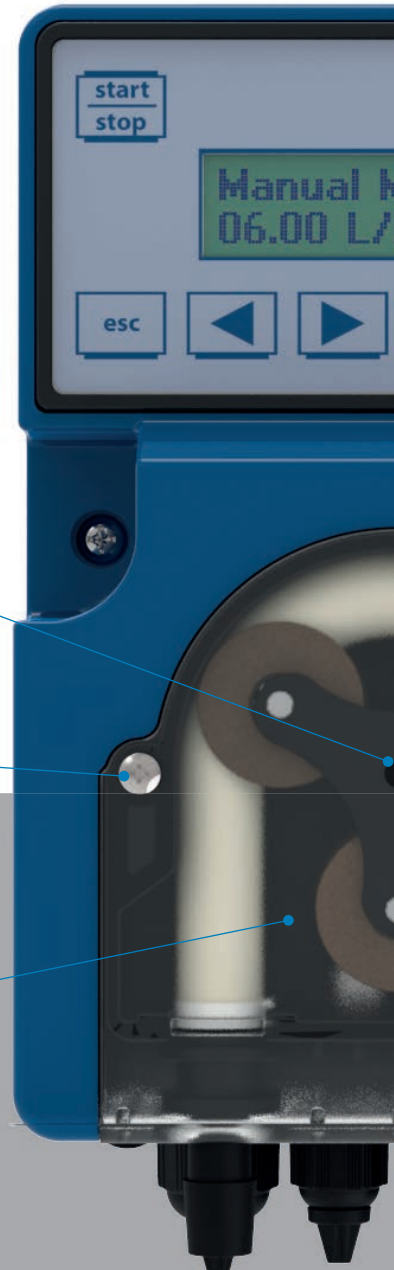

DosingPump.ir

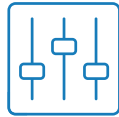

Intuitive menu and special functions

Access tube life data to facilitate maintenance planning

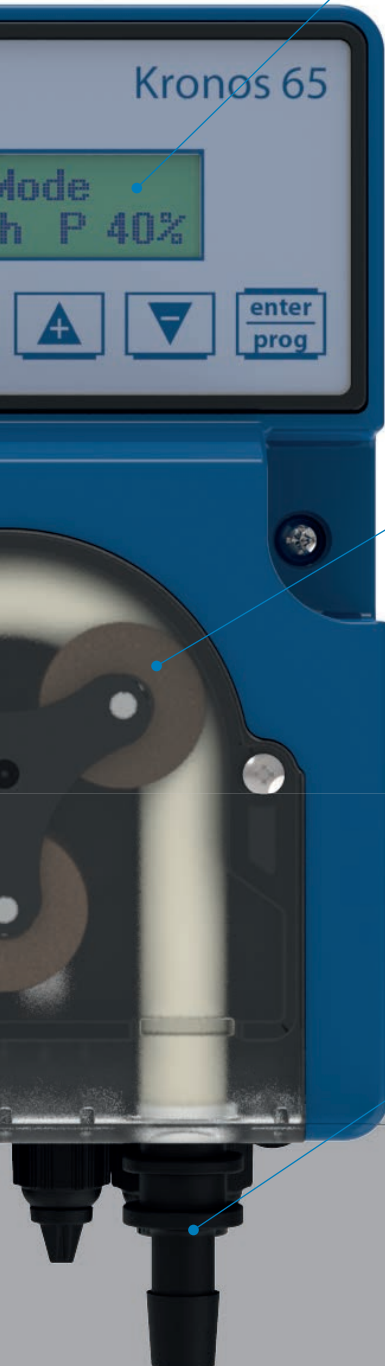

Three-roller system

Limits tube stretching, while reverse rotation feature empties tubes between doses for reduced degradation



Chemical compatibility

Kronos accepts a wide range of peristaltic tubing to ensure exceptional chemical compatibility in every application

*Available on selected models

Applications

The versatile Kronos Series is suited to multiple water-treatment applications, including:

- Drinking water
- Irrigation systems
- Cooling towers
- Swimming pools
- Wastewater

Kronos 65

The peristaltic Kronos pump with a higher flow rate

Among the Kronos pumps, Kronos 65 offers the highest flow rate, up to 25 l/h at low pressures.

- Flow rate range: 25 l/h - 0.1 bar
- Tube: Santoprene



Kronos 65 is available in the FM model, which features proportional dosing and accepts an analogue 4-20mA signal or a digital frequency signal such as that generated by a pulse-emitting water meter. The pump then doses at a flow rate proportional to this signal, according to the programmed ratio.

Of course, the user can also configure the pump in constant mode and, in this case, the pump will dose at the programmed flow rate in the presence of an external activation trigger.

The pump is equipped with a powerful stepper motor and is provided with a 65mm peristaltic head.

The integrated "Tube Break Alarm" mechanism is able to identify chemical leakage inside the peristaltic head and block dosing.

The durable ABS case with IP65 protection allows the pump to be used even in applications where it may be subject to small water splashes or dust.

Features

Direct driving stepper motor

Santoprene peristaltic tube

PTFE rollers mounted on ball bearings

Intuitive digital interface: 7 keys and a 2x16 LCD display

FM: Proportional dosing with 4-20mA/pulse input

Wall-mounting bracket

Kronos 65 key code

Range	
KS	Kronos 65 Series - Peristaltic dosing pump
Type	
FM	Proportional dosing by external pulse or 4 – 20 mA signal
Pressure [bar]	
00	0.1
Flow rate [l/h]	
25	25 l/h
Power supply	
M	100 - 240 Vac – Wide Range
Tubes	
1	Santoprene
Communication	
0	No communication
Optional	
00	Standard

KS	FM	00	25	M	1	0	00
----	----	----	----	---	---	---	----

Model Type FM

Proportional dosing: The pump accepts as input an analogic 4-20mA signal, or a digital frequency signal and doses at a flow rate proportional to this signal, according with the programmed ratio. A pulse-emitting water meter can be connected directly to the digital signal input and, in this case, the pump will dose at a flow-rate that will be proportional to the flow-rate of the water in the pipeline.

Kronos 50

Peristaltic dosing pumps for water and industrial applications

As with the other Kronos pumps, Kronos 50 is equipped with a stepper motor that provides infinitely adjustable (0.1- 100%) and silent dosing. Its advanced technology and materials mean the various models can reach flow rates of up to 15 l/h (at 0.1 bar) and can dose at back pressures up to 4 bar with a special HP-San tube.

- Flow rate range: 2 - 15 l/h, up to 4 bar
- Tube: Santoprene - SekoExtra - SekoMed - Sekofort - HP-San



The digital programming of parameters via keyboard and display ensures a fast set up and final check on the programming data. The easy and intuitive menu enables a simple setting of the various options without the risk of forgetting anything. The internal menu also allows users to check statistics on the life of the tube and the operating life of the pump.

Features

Potable water treatment (injection of coagulants, flocculating agents, sodium hypochlorite, lime slurry, acid, bases, caustic soda and activated carbon)

Domestic or industrial wastewater treatment, boiler feed water and cooling water

Chemical treatment, electrolytic (electro-plating) treatments: addition of degreasing agents, cleaning agents, nickel electroplating and chemical nickel plating, copper plating and tinning

Kronos 50 key code

Model	
KT	Kronos Series - Peristaltic dosing pump
Type	
HX	pH or Redox
EC	With conductivity meter built in for cooling tower
FM	Proportional dosing by external pulse or 4 – 20 mA signal
FF	Proportional dosing by external 0-10 Vdc, external pulse or 4-20 mA signal
Pressure [bar]	
00	0.1
02	2
03	3
04	4
Flow rate [l/h]	
02	2
04	4
10	10
15	15
Power supply	
M	100 - 240 Vac
Tubes	
1	Santoprene
5	SekoExtra
6	Sekomed
8	SekoFort
5	HP-San
Communication	
0	No communication
Optional	
00	Standard

KR	HX	1H	07	M	1	0	00
----	----	----	----	---	---	---	----

Model Type EC

with conductivity meter built in for cooling towers

Three basic functions: anti-scaling proportional dosing via external pulse signal; open drain valve for blow down function via conductivity feedback measure; disable drain action after chemical dosing via software setting.

Model Type HX

with pH/ORP controller meter built in

One basic function: proportional chemical dosing by pH or redox analysis. The pump has galvanized electrical insulation.

Model Type FM

Two basic functions: proportional dosing by external pulse or 4 – 20 mA signal. The pump has galvanized electrical insulation. Special version with SekoFort tube for mineral oil and with HP-San tube for high pressure.

Model Type FF

Three basic functions: proportional dosing by external 0-10 Vdc, pulse or 4-20 mA signal. The pump has galvanized electrical insulation.

Kronos 20

Peristaltic dosing pumps for water and industrial applications

Kronos 20 is a higher-level professional pump suitable for use in medium-duty applications, operating a single function - proportional chemical dosing. Reading either pH or ORP, the pump features fully galvanized electrical insulation.

- Flow rate range: 7 l/h - 1.5 bar
- Tube: Santoprene



Applications

Kronos Series meets the needs of water and industry applications.

To date, Kronos finds can be found in the following areas:

- Drinking water applications
- Irrigation systems
- Cooling tower applications
- Swimming pools
- Flocculent dosing systems
- Priming of chemical products that release gas easily

Features

Potable water treatment (injection of coagulants, flocculating agents, sodium hypochlorite, lime slurry, acid, bases, caustic soda and activated carbon)

Domestic or industrial wastewater treatment, boiler feed water and cooling water

Chemical treatment, electrolytic (electro-plating) treatments: addition of degreasing agents, cleaning agents, nickel electroplating and chemical nickel plating, copper plating and tinning

Kronos is easy to install, with a fastener system that facilitates maintenance of the electronic circuitry, reducing cost and complexity by eliminating the need to remove connections that have already been made.

All parts of the mechanism have permanent lubrication, using ball bearings for the principal moving components that helps prevent overheating and extends the pump life with the added benefit of low-decibel operation.

Kronos 20 key code

Model							
KT	Kronos Series - Peristaltic dosing pump						
Type							
HX	pH or Redox						
Pressure [bar]							
1H	1.5						
Flow rate [l/h]							
07	7						
Power supply							
M	100 - 240 Vac						
Tubes							
1	Santoprene						
Communication							
0	No communication						
Optional							
00	standard						
KR	HX	1H	07	M	1	0	00

Model Type HX with pH/ORP controller meter built in

One basic function: proportional chemical dosing by pH or redox analysis. The pump has galvanized electrical insulation.

DosingPump.ir



















AODD Pumps

Air-Operated Double-Diaphragm



Product Overview

								
PP	•	•	•	•	•	•		•
PVDF+CF	•	•	•	•	•	•		•
POMc	•	•	•					
ALU				•	•		•	
SS316		•	•	•	•			
Fluid connections	1/4" BSP	3/8" BSP	1/2" BSP	1/2" BSP	1/2" BSP	3/4" BSP	3/4" BSP	1" BSP
Air connection	4 mm	6 mm	6 mm	1/4" BSP	1/4" BSP	3/8" BSP	3/8" BSP	3/8" BSP
Max flow rate	7 l/m	20 l/min	35 l/min	55 l/min	65 l/min	100 l/min	120 l/min	120 l/min
Max air pressure	6 bar	7 bar	7 bar	8 bar	8 bar	8 bar	8 bar	8 bar
Max delivery head	60 m	70 m	70 m	80 m	80 m	80 m	80 m	80 m
Max suction lift dry	3 m	5 m	5 m	5 m	5 m	5 m	5 m	5 m
Max suction lift wet	9.8 m	9.8 m	9.8 m	9.8 m	9.8 m	9.8 m	9.8 m	9.8 m
Max solid passing	2 mm	2.5 mm	3 mm	3.5 mm	3.5 mm	4 mm	4 mm	4 mm
Noise level	62 dB	65 dB	65 dB	70 dB	72 dB	72 dB	72 dB	72 dB
Max viscosity	5,000 cps	10,000 cps	15,000 cps	20,000 cps	20,000 cps	15,000 cps	25,000 cps	25,000 cps
Displacement per stroke	18 cc	30 cc	65 cc	140 cc	140 cc	200 cc	200 cc	200 cc

								
PP		•	•		•	•	•	•
PVDF+CF		•	•		•	•	•	•
POMc								
ALU	•			•		•	•	•
SS316						•	•	•
Fluid connections	1" BSP	1" BSP DN25	1" BSP	1 1/4" BSP	1 1/4" BSP	1 1/2" BSP DN40	2" BSP DN50	2" BSP DN80
Air connection	1/2" BSP	1/2" BSP	1/2" BSP	1/2" BSP	1/2" BSP	1/2" BSP	3/4" BSP	3/4" BSP
Max flow rate	170 l/min	170 l/min	170 l/min	250 l/min	250 l/min	380 l/min	700 l/min	1,050 l/min
Max air pressure	8 bar	8 bar	8 bar	8 bar	8 bar	8 bar	8 bar	8 bar
Max delivery head	80 m	80 m	80 m	80 m	80 m	80 m	80 m	80 m
Max suction lift dry	6 m	5 m	5 m	6 m	5 m	5 m	5 m	5 m
Max suction lift wet	9.8 m	9.8 m	9.8 m	9.8 m	9.8 m	9.8 m	9.8 m	9.8 m
Max solid passing	7.5 mm	7.5 mm	7.5 mm	7.5 mm	7.5 mm	8 mm	8.5 mm	12 mm
Noise level	75 dB	75 dB	75 dB	75 dB	75 dB	78 dB	78 dB	82 dB
Max viscosity	35,000 cps	35,000 cps	35,000 cps	35,000 cps	35,000 cps	40,000 cps	50,000 cps	55,000 cps
Displacement per stroke	700 cc	700 cc	700 cc	700 cc	700 cc	1,200 cc	3,050 cc	9,750 cc

SEKO's Duotek pumps are renowned for their flexibility in pumping difficult liquids at low pressure and flow.

SEKO's Duotek pumps come in many sizes and material choices. Almost every type of liquid, from highly-corrosive acids through high-viscosity paints and adhesives to food and drink products, can be pumped. The range of applications is virtually limitless.

Performance

- Variable flow and head pressures; easy to adjust without sophisticated controls
- Portable and compact for multi-location use, optionally with trolley
- Handles liquids with solid particles; ideal for abrasive and viscous media
- Special air system; lube-free, non-stall, non-freeze
- Wide range of sizes and materials suited to variety of conditions and chemical fluids
- Efficient performance; high flow rates through optimal casing designs
- Self-priming dry up to six metres; works in suction lift applications
- Efficient air distribution design with low air consumption
- Can be customized to specific applications; multiple porting options available along with interface options
- Safe "dead head" function against closed discharge without pump damage

Reliability

- 100% wet tested after final assembly; deadheading, priming, and sealing
- All-plastic air system; strong and corrosion resistant in harsh environments
- Dry-run without damaging the pump or system; seal-less design
- Serviceability: quickly and easily maintained without any special tools

Security

- All versions ATEX certified; conductive plastic pumps available
- Special air exhaust; designed to operate at low noise levels
- Fully submersible; can be immersed completely according to fluid compatibility
- All-bolted construction provides maximum leak resistance and safety

Markets and Applications

Air-operated double-diaphragm pumps are among the most versatile liquid transfer solutions on the market. They can be used in a variety of installations in numerous applications.

- Automotive ■ Agriculture ■ Mechanical ■ Chemical ■ Ceramic ■ Food
- Biodiesel ■ Ceramic ■ Textile & Leather ■ Paint and Varnish ■ Naval & Petrochemical
- Pulp & Paper ■ Mining ■ Pharmaceutical & Cosmetic ■ Galvanic ■ Oil & Gas
- Water Treatment ■ Printing Inks



Product range

Duotek

PP, PVDF, ALUMINIUM, SS AISI 316, POMc
 Flow rate from 8 - 1,000 l/min
 Connection from 1/4" - 3"



Duotek Accurate

Features remote control
 PP, PVDF, ALUMINIUM, SS AISI 316, POMc
 Flow rate from 8 - 700 l/min Connection 1/4" - 2"



Duotek Drum

Empties drums and tanks
 PP, PVDF, ALUMINIUM, SS AISI 316, POMc
 Flow rate 8 - 160 l/min
 Connection 1/4" - 1"









Duotek Twin

Features double inlet/outlet
 PP, PVDF, ALUMINIUM, SS AISI 316, POMc
 Flow rate from 8 - 700 l/min
 Connection 1/4" - 2"



Why choose Duotek?

							
	AODD	Centrifugal	Lobe	Gear	Screw	Peristaltic	Piston
Variable Flow & Head Control	✓	✓	✓	✓	!	!	✓
Deadhead Safely	✓	✓	!	!	!	!	!
Dry-Running	✓	×	×	×	×	×	×
Dry Self-Priming	✓	×	×	✓	×	✓	!
No Mechanical Alignment	✓	×	×	×	×	×	×
No Electrical Installation	✓	×	×	×	×	×	×
Portability	✓	✓	!	!	!	✓	!
Submersible	✓	!	×	×	×	×	!
Seal-less	✓	!	!	!	!	!	!
Cavitation Tolerance	✓	×	!	!	✓	!	!
Low Shear & Degradation	✓	×	✓	✓	!	!	!

✓ = Suitable ! = Limitations × = Not Recommended

Materials - Pump Casing



Polypropylene
Wide chemical compatibility.
General purpose.



Aluminium
Wide range of solvent and hydrocarbons resistance. Good level of abrasion resistance.



PVDF+CF
Conductive PVDF: Strong chemical resistance to acids.
High temperature resistance.
Groundable.



SS316
Stainless steel 316: High level of corrosion and abrasion resistance.



POMc
Acetal: Wide range of solvent and hydrocarbons resistance.
Good level of abrasion resistance.

Solenoid-Driven Pumps

Motor-Driven Pumps

Peristaltic Pumps

Materials

Diaphragm

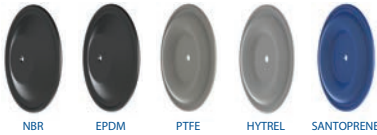

NBR Good for petroleum-based fluids, water, oils, hydrocarbons and mild chemicals.
EPDM OK with caustic solutions, dilute acids, ketones and alcohols. Good abrasion resistance.
PTFE Widest chemical compatibility, extreme corrosion resistance, non-adhesive, high heat resistance.
HYTREL Good low temperature properties. Good abrasion resistance.
SANTOPRENE Solutions and dilute acids.

Ball Check

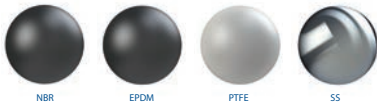

NBR Good for petroleum-based fluids, water, oils, hydrocarbons and mild chemicals.
EPDM OK with caustic solutions, dilute acids, ketones and alcohols. Good abrasion resistance.
PTFE Widest chemical compatibility, extreme corrosion resistance, non-adhesive, high heat resistance.
SS High level of corrosion and abrasion resistance. Good for viscous fluids.

Seat



POLYPROPYLENE Wide chemical compatibility. General purpose.
PVDF Strong chemical resistance to acids. High temperature resistance.
ALUMINIUM Wide range of solvent and hydrocarbons resistance. Good level of abrasion resistance.
SS High level of corrosion and abrasion resistance.
PE with high molecular weight: High level of abrasion resistance

O-rings



VITON High heat resistance. Good resistance to aggressive chemicals and hydrocarbons.
NBR Good for petroleum-based fluids, water, oils, hydrocarbons and mild chemicals.
EPDM OK with caustic solutions, dilute acids, ketones and alcohols. Good abrasion resistance.
PTFE Widest chemical compatibility, extreme corrosion resistance, non-adhesive, high heat resistance.

AODD Pumps

Blowers

Accessories

Duotek AODD key code

Model									
AF	Pneumatic Diaphragm Pumps								
Type									
00	Zone 2 ATEX								
Series	Flow rate [l/m]	Connections [BSP]		* Suc lift max [m]	Del head max [m]	Solid passing [0mm]	Displac./cycle [cc]	Viscosity max [cps]	
		Fluid	Air						
0007	7	1/4"	4mm	3	60	2	18	6,000	
0018	20	3/8"	6mm	5	70	2.5	30	10,000	
0030	35	1/2"				1/4"	3	65	15,000
0055	55		3/4"		3/8"		3.5	140	20,000
0060	65	1"				80	4	200	15,000
0090	100		1"		3/8"		7.5	700	35,000
**0100	100	1"				1/2"	8	1,200	40,000
0120	120		1"		1"		8.5	3,050	50,000
**0160	170	1"				1 1/4"	10	7,000	55,000
0170	170		DN25 - 1"		3/4"				
0171	170	1"							
**0250	250	1 1/4"							
0252	250								
0400	380	DN40 - 1 1/2"							
0700	700	DN50 - 2"							
1000	1,050	DN80 - 3"							

Body Material	
P	Polypropylene + Glass Fibre
K	PVDF + Carbon Fibre
A	Aluminium
S	SS 316
M	POM

Air Diaphragm	
H	Hytrel
M	Santoprene
D	EPDM
N	NBR

Fluid Diaphragm	
T	PTFE
X	Without diaphragm PTFE

Balls	
T	PTFE
S	SS 316
D	EPDM
N	NBR

Motor poles/phases	
P	Polypropylene
K	PVDF pure
S	AISI 316
A	Aluminium
M	POMc
Z	PE

O-Rings	
D	EPDM
V	FPM
T	PTFE
N	NBR

Customization	
1	BSP threaded
2	Flanged
4	Twin connection
5	NPT threaded
6	Reinforcement ring
7	Extra connections

Customization	
-	None
E	Ext. control with solenoid
D	Ext. control without solenoid

AF	00	0007	P	N	T	T	P	T	1	E
----	----	------	---	---	---	---	---	---	---	---

AODD Pumps

DosingPump.ir

* FLANGED: add the cost of the related KIT
 ** Casing in Aluminium ONLY

* With DRY pump. To WET pump: 9.38 m
 Max AIR pressure: 0007 / 6 bar, 0018 - 0030 / 7 bar, others 8 bar

Duotek



Air-operated double-diaphragm pumps

Air-operated double-diaphragm pumps have long been recognized as the most flexible pumps for handling difficult liquids at relatively low pressures and flows in a virtually limitless range of applications. SEKO AODD pumps come in many sizes and materials of construction. Almost every type of liquid, from highly-corrosive acids through high-viscosity paints and adhesives to food and drink products, can be pumped.

Made in PP, PVDF, ALUMINIUM, SS316, POMc

Flow rate from 8 l/min to 1,000 l/min

Connection from 1/4" to 3"

ATEX certification for zone 2

EX II 3/3 GD c IIB T135°C

Technical features



Long-lasting diaphragm construction ensures consistent performance and extended operating life.



Special exhaust chamber with double silencer to expand diffusion passages, reduce icing and ensure low noise level. Air consumption is significantly lowered.



Special pinch clamping design to minimize wear and increase life of the diaphragm. Provides a uniform seal to avoid leakage.

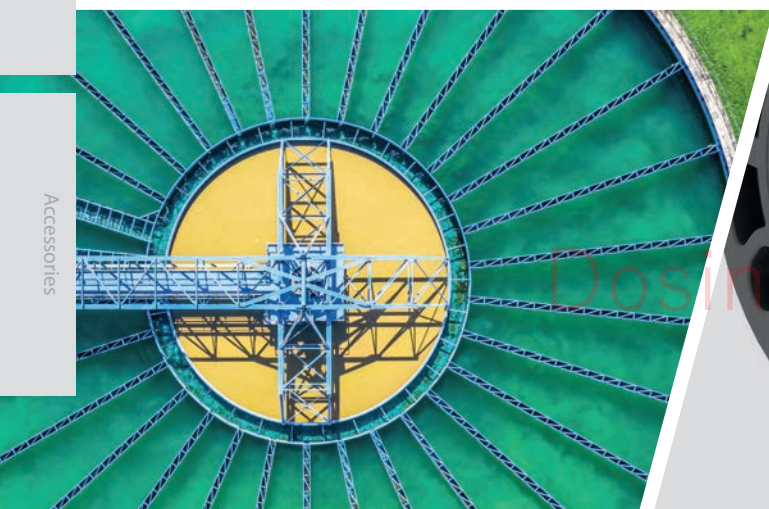
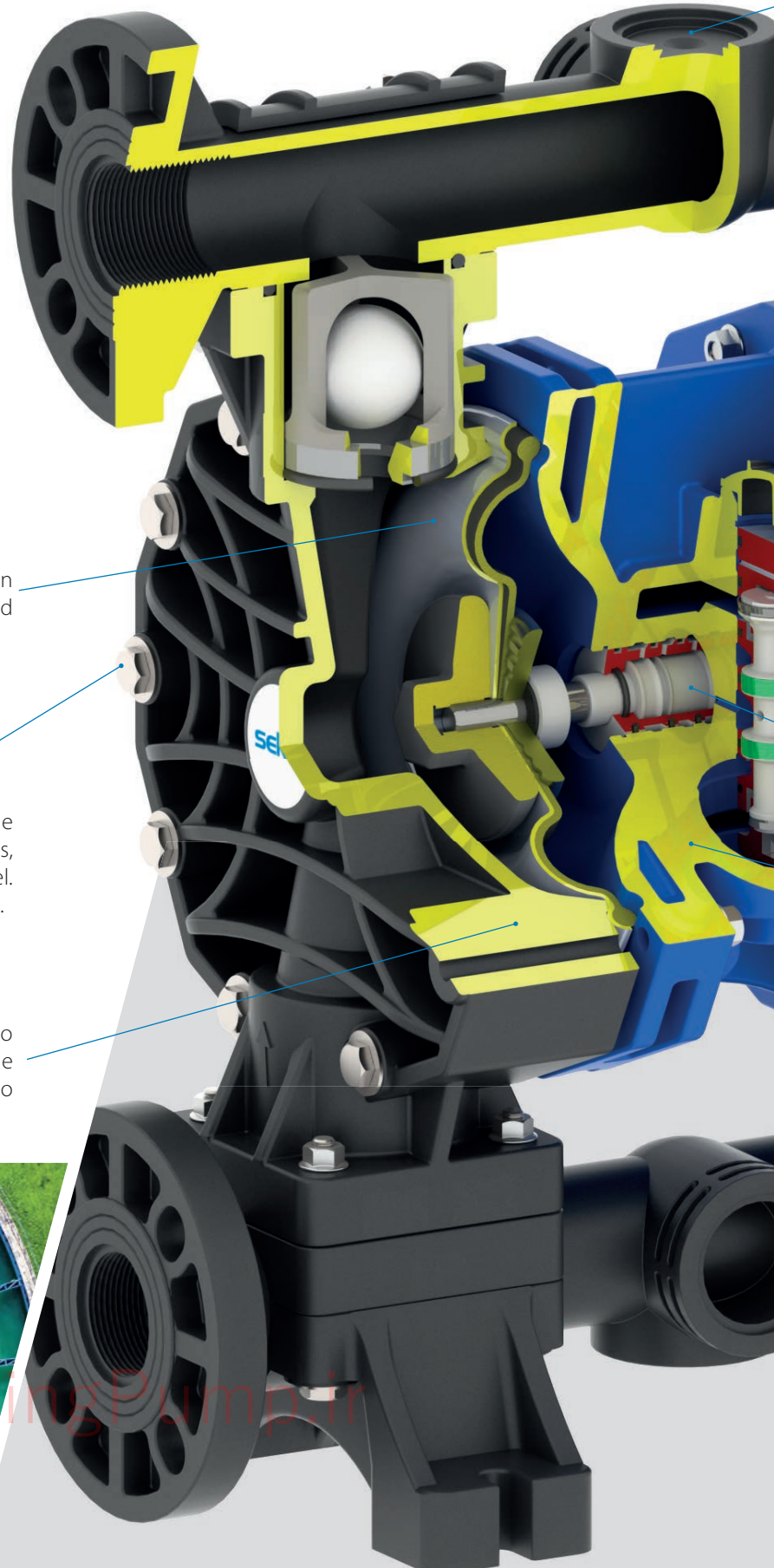

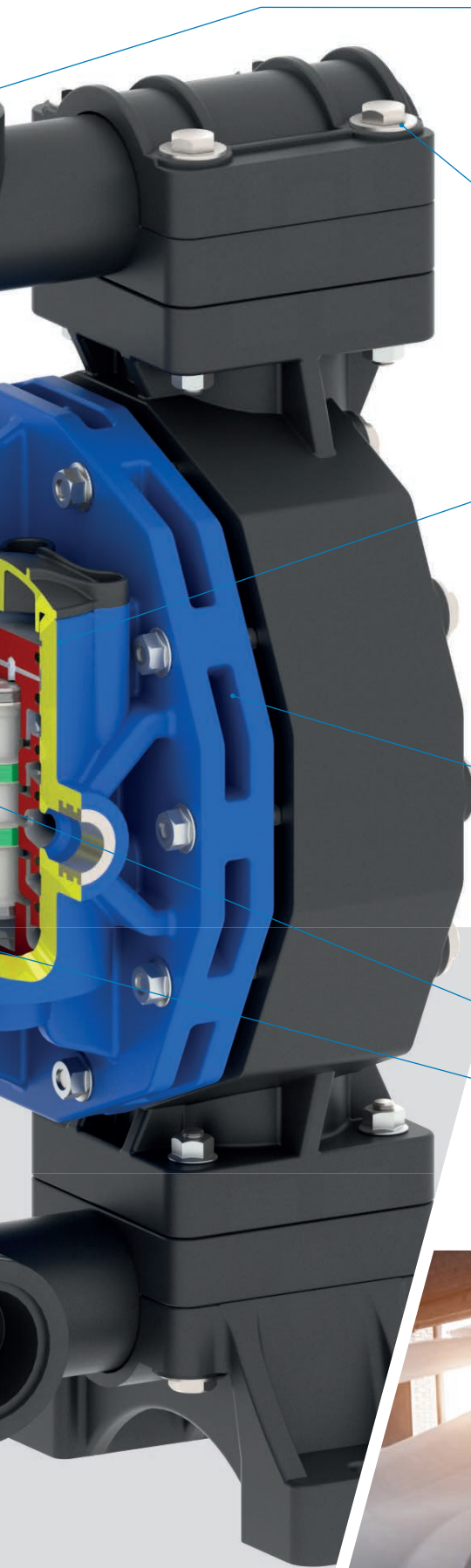

Duotek's one-piece manifold is designed to ensure high performance with zero leakage risk, unlike traditional multi-piece manifold units.

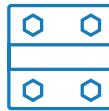

All-bolted design for an effective sealing to extend leak-proof service.



Unbalanced pilot spool precisely controls positioning of the main power spool to eliminate stalling and increase efficiency.



The Duotek central block is made of PP rather than aluminium as this ensures much greater chemical compatibility and continued high performance even in high-humidity environments.

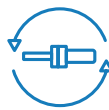

Acetal shuttle ensures long valve life with auto-lubricated material.



Pneumatic exchanger is easily externally accessible for quick inspection, also includes enlarged valve diameter and increased maximum dry suction height.



Duotek AF0007

 EX II 3/3 GD c IIB T 135°C

Technical data

Fluid connections	1/4" BSP
Air connection	4 mm
Max flow rate	7 l/min
Max air pressure	6 bar
Max delivery head	60 m
Max suction lift dry	3 m
Max suction lift wet	9.8 m
Max solid passing	2 mm
Noise level	62 dB
Max viscosity	5,000 cps
Displacement per stroke	18 cc



PP



PVDF+CF



POMc

Duotek AF0018

 EX II 3/3 GD c IIB T 135°C

Technical data

Fluid connections	3/8" BSP
Air connection	6 mm
Max flow rate	20 l/min
Max air pressure	7 bar
Max delivery head	70 m
Max suction lift dry	5 m
Max suction lift wet	9.8 m
Max solid passing	2.5 mm
Noise level	65 dB
Max viscosity	10,000 cps
Displacement per stroke	30 cc

PP



PVDF+CF



POMc



SS316

Duotek AF0030

 EX II 3/3 GD c IIB T 135°C

Technical data

Fluid connections	1/2" BSP
Air connection	6 mm
Max flow rate	35 l/min
Max air pressure	7 bar
Max delivery head	70 m
Max suction lift dry	5 m
Max suction lift wet	9.8 m
Max solid passing	3 mm
Noise level	65 dB
Max viscosity	15,000 cps
Displacement per stroke	65 cc



PP



PVDF+CF



POMc



SS316

Duotek AF0055

 EX II 3/3 GD c IIB T 135°C

Technical data

Fluid connections	1/2" BSP
Air connection	1/4" BSP
Max flow rate	55 l/min
Max air pressure	8 bar
Max delivery head	80 m
Max suction lift dry	5 m
Max suction lift wet	9.8 m
Max solid passing	3.5 mm
Noise level	70 dB
Max viscosity	20,000 cps
Displacement per stroke	140 cc



PP



PVDF+CF



ALU



SS316

Duotek AF0060

 EX II 3/3 GD c IIB T 135°C

Technical data

Fluid connections	1/2" BSP
Air connection	1/4" BSP
Max flow rate	65 l/min
Max air pressure	8 bar
Max delivery head	80 m
Max suction lift dry	5 m
Max suction lift wet	9.8 m
Max solid passing	3.5 mm
Noise level	72 dB
Max viscosity	20,000 cps
Displacement per stroke	140 cc



PP



PVDF+CF

ALU

SS316

Duotek AF0090

 EX II 3/3 GD c IIB T 135°C

Technical data

Fluid connections	3/4" BSP
Air connection	3/8" BSP
Max flow rate	100 l/min
Max air pressure	8 bar
Max delivery head	80 m
Max suction lift dry	5 m
Max suction lift wet	9.8 m
Max solid passing	4 mm
Noise level	72 dB
Max viscosity	15,000 cps
Displacement per stroke	200 cc



PP



PVDF+CF

DosingPump.ir

Duotek AF0100

 EX II 3/3 GD c IIB T 135°C

Technical data

Fluid connections	3/4" BSP
Air connection	3/8" BSP
Max flow rate	120 l/min
Max air pressure	8 bar
Max delivery head	80 m
Max suction lift dry	5 m
Max suction lift wet	9.8 m
Max solid passing	4 mm
Noise level	72 dB
Max viscosity	25,000 cps
Displacement per stroke	200 cc



Duotek AF0120

 EX II 3/3 GD c IIB T 135°C

Technical data

Fluid connections	1" BSP
Air connection	3/8" BSP
Max flow rate	120 l/min
Max air pressure	8 bar
Max delivery head	80 m
Max suction lift dry	5 m
Max suction lift wet	9.8 m
Max solid passing	4 mm
Noise level	72 dB
Max viscosity	25,000 cps
Displacement per stroke	200 cc



Duotek AF0160

 EX II 3/3 GD c IIB T 135°C

Technical data

Fluid connections	1" BSP
Air connection	1/2" BSP
Max flow rate	170 l/min
Max air pressure	8 bar
Max delivery head	80 m
Max suction lift dry	6 m
Max suction lift wet	9.8 m
Max solid passing	7.5 mm
Noise level	75 dB
Max viscosity	35,000 cps
Displacement per stroke	700 cc



ALU

Duotek AF0170

 EX II 3/3 GD c IIB T 135°C

Technical data

Fluid connections	1" BSP DN 25
Air connection	1/2" BSP
Max flow rate	170 l/min
Max air pressure	8 bar
Max delivery head	80 m
Max suction lift dry	5 m
Max suction lift wet	9.8 m
Max solid passing	7.5 mm
Noise level	75 dB
Max viscosity	35,000 cps
Displacement per stroke	700 cc



PP



PVDF+CF

Duotek AF0171

 EX II 3/3 GD c IIB T 135°C

Technical data

Fluid connections	1" BSP DN 25
Air connection	1/2" BSP
Max flow rate	170 l/min
Max air pressure	8 bar
Max delivery head	80 m
Max suction lift dry	5 m
Max suction lift wet	9.8 m
Max solid passing	7.5 mm
Noise level	75 dB
Max viscosity	35,000 cps
Displacement per stroke	700 cc



Duotek AF0250

 EX II 3/3 GD c IIB T 135°C

Technical data

Fluid connections	1" 1/4 BSP
Air connection	1/2" BSP
Max flow rate	250 l/min
Max air pressure	8 bar
Max delivery head	80 m
Max suction lift dry	6 m
Max suction lift wet	9.8 m
Max solid passing	7.5 mm
Noise level	75 dB
Max viscosity	35,000 cps
Displacement per stroke	700 cc



Duotek AF0252

 EX II 3/3 GD c IIB T 135°C

Technical data

Fluid connections	1" 1/4 BSP
Air connection	1/2" BSP
Max flow rate	250 l/min
Max air pressure	8 bar
Max delivery head	80 m
Max suction lift dry	5 m
Max suction lift wet	9.8 m
Max solid passing	7.5 mm
Noise level	75 dB
Max viscosity	35,000 cps
Displacement per stroke	700 cc



ALU



PVDF+CF

Duotek AF0400

 EX II 3/3 GD c IIB T 135°C

Technical data

Fluid connections	1" 1/2 BSP DN 40
Air connection	1/2" BSP
Max flow rate	380 l/min
Max air pressure	8 bar
Max delivery head	80 m
Max suction lift dry	5 m
Max suction lift wet	9.8 m
Max solid passing	8 mm
Noise level	78 dB
Max viscosity	40,000 cps
Displacement per stroke	1,200 cc



PP



PVDF+CF

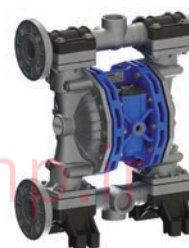

ALU



SS316

Duotek AF0700

 EX II 3/3 GD c IIB T 135°C

Technical data

Fluid connections	2" BSP DN 50
Air connection	3/4" BSP
Max flow rate	700 l/min
Max air pressure	8 bar
Max delivery head	80 m
Max suction lift dry	5 m
Max suction lift wet	9.8 m
Max solid passing	8.5 mm
Noise level	78 dB
Max viscosity	50,000 cps
Displacement per stroke	3,050 cc



PP



PVDF+CF

ALU

SS316

Duotek AF1000

 EX II 3/3 GD c IIB T 135°C

Technical data

Fluid connections	3" BSP DN 80
Air connection	3/4" BSP
Max flow rate	1,050 l/min
Max air pressure	8 bar
Max delivery head	80 m
Max suction lift dry	5 m
Max suction lift wet	9.8 m
Max solid passing	12 mm
Noise level	82 dB
Max viscosity	55,000 cps
Displacement per stroke	9,750 cc



PP



PVDF+CF

ALU

SS316

Performance curves

The curves and performance values refer to pumps with submerged suction and a free delivery outlet with water at 20°C and vary according to the construction material.

● Air supply pressure ● Air consumption Nlt/min

Solenoid-Driven Pumps

Motor-Driven Pumps

Peristaltic Pumps

AODD Pumps

Blowers

Accessories

Duotek AF0007

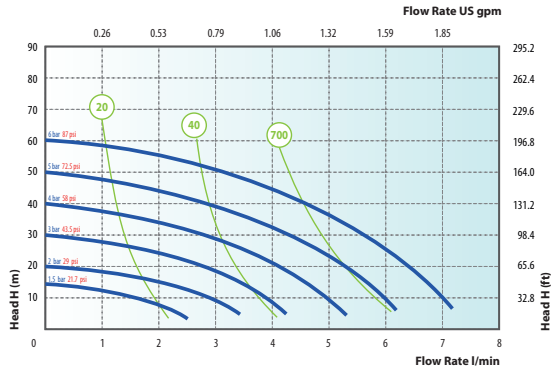

Duotek AF0018

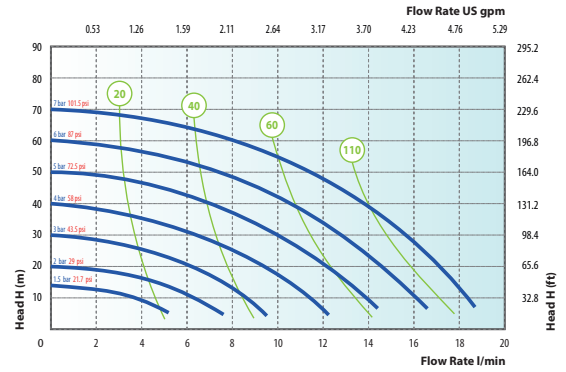

Duotek AF0030

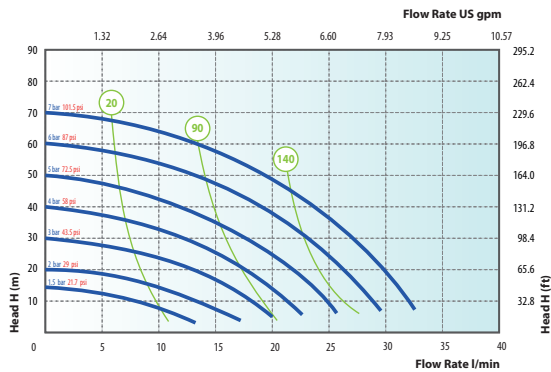

Duotek AF0055

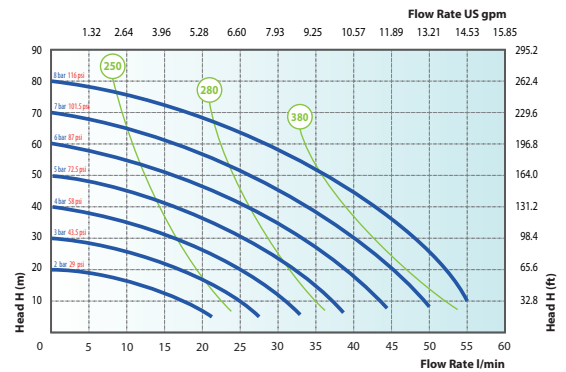

Duotek AF0060

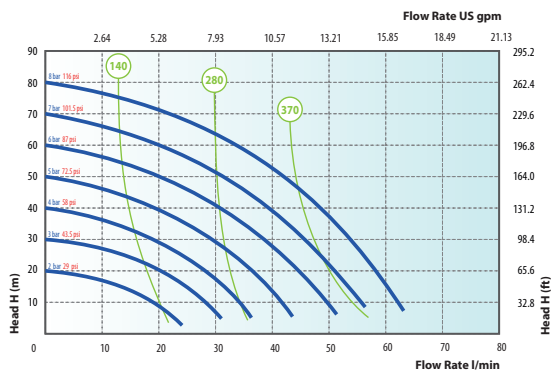

Duotek AF0090

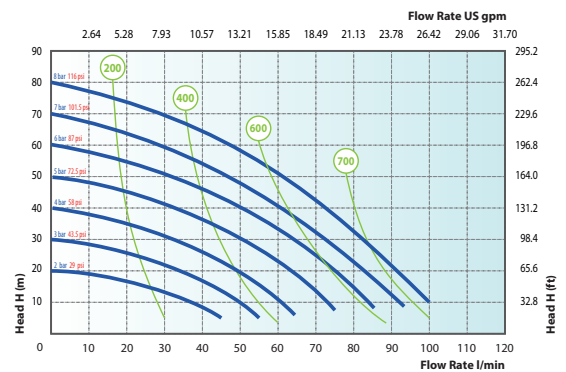

Duotek AF0100

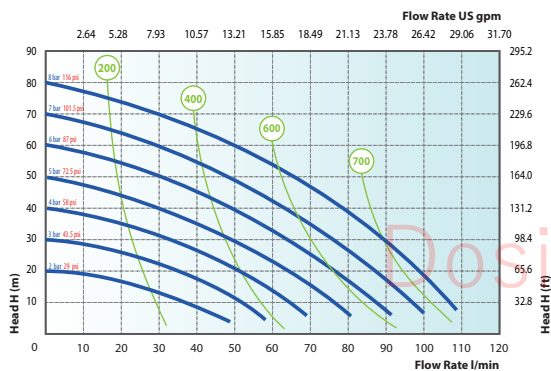

Duotek AF0120

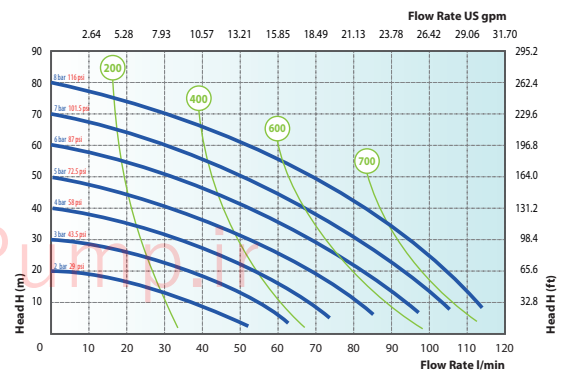

DosingPump.nl

Special Pumps

Accurate Duotek

Technical data

Accurate Duotek pumps give you the necessary external pump control for exacting applications such as batching. Featuring a direct electrical interface that utilizes electrical impulses to stroke the pump instead of differential pressure, the Accurate Duotek provides an easily-controlled variable stroke rate.

Note PLC and computer system not included.

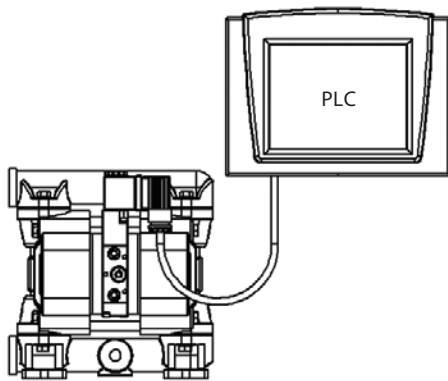

Main applications

- Chemical industry
- Flexographic industry
- Painting industry
- Wastewater technology
- Printing industry

Pumps

AF0007; AF0018; AF0030;
AF0100; AF0160; AF0250

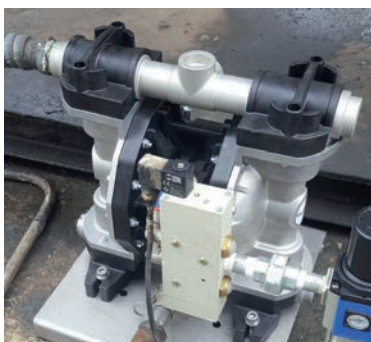
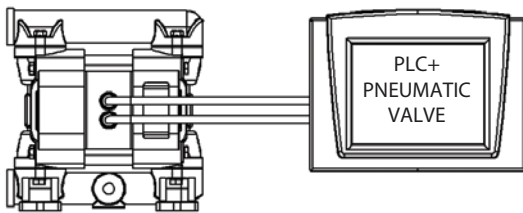

Special Pumps

Drum Duotek

Technical data

Drum Duotek is designed for emptying drums and containers and provides an economical and wear-resistant alternative to other pumping systems. In order to handle a wide range of fluids, DP pumps are available in all materials. The pump can be quickly and easily foot-mounted on the drum. The drum will be completely emptied with a suction pipe.

Main applications

- Chemical industry
- Waste disposal technology
- Automotive industry
- Food industry

Pumps

AF0018; AF0030;
AF0100; AF0160



Special Pumps

Twin Duotek

Technical data

Twin Duotek pumps are mainly used in the textile and paper processing industry. These dual-action pumps are able to transfer two different media independently and simultaneously. This is accomplished by using separate connections on the suction and discharge ports, keeping two pumped media isolated from each other and preventing unwanted mixing.

Main applications

- Chemical industry
- Flexographic industry
- Painting industry
- Wastewater technology
- Printing industry

Pumps

AF0018; AF0030; AF0100;
AF0160; AF0250; AF0400



DosingPump.ir

Damper

Pneumatic, automatic pulsation dampers

Made in PP, PVDF, ALUMINIUM, SS316, POMc

Applicable to all pump sizes



The active pulsation damper is the most efficient way to remove pressure variations on the discharge of the pump. SEKO pulsation dampers work actively with compressed air and a diaphragm, automatically setting the correct pressure to minimize pulsations. Pulsation dampers require minimal maintenance and are, subject to the requirements of the application, available in the same housing and diaphragm materials as the pump.

Applications

- Metering/injection/dosing (equalizes discharge pressure spikes, increasing accuracy)
- Filter press/in-line filters (increases filter efficiency and life by providing a smooth flow)
- Spraying (smooth, consistent spray pattern)
- Filling (eliminates inconsistent filling and splashing)
- Transfer (eliminates harmful water hammer, preventing pipe and valve damage)



Significant pulsation reduction with an average 70%-80% pulsation reduction in high back pressure applications.

DosingPump.it

How it works

The pulsating flow of the discharge forces the diaphragm upwards where it is cushioned by the air in the chamber. The flexing of the diaphragm absorbs the pulsation, providing a smooth flow.

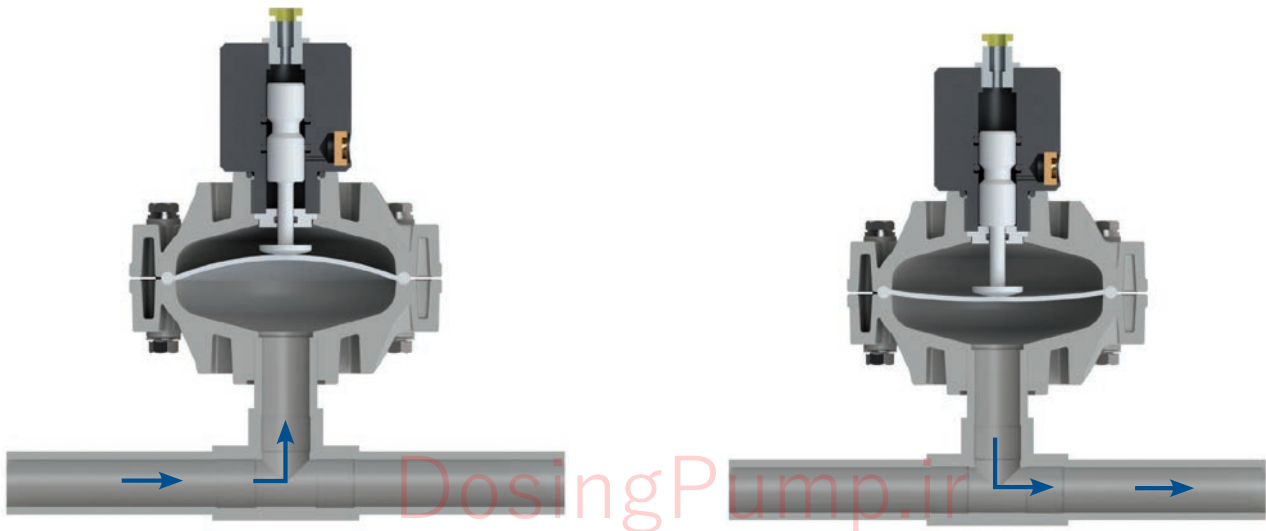
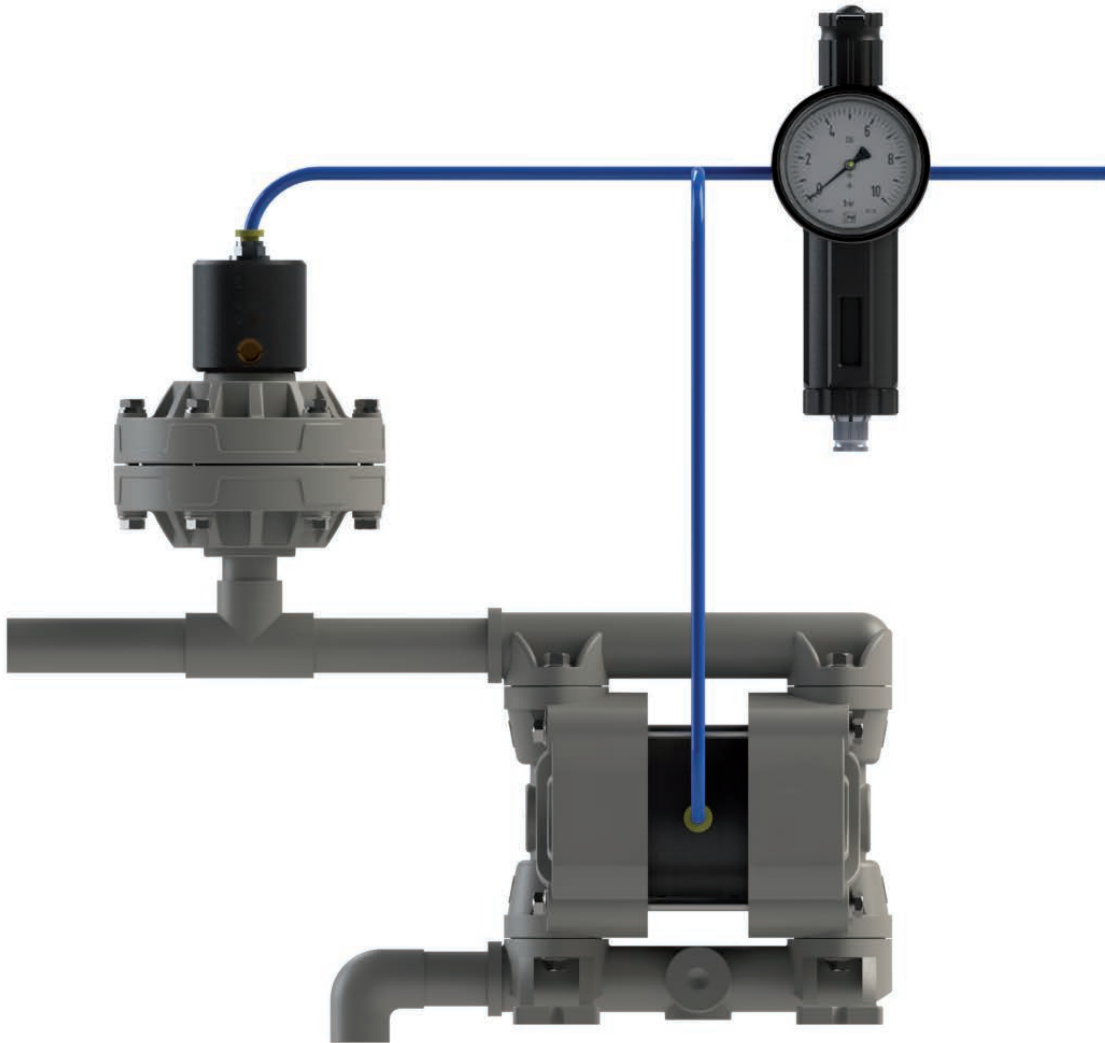

Damper DAF20

Technical data

Fluid connections	3/4"
Air connection	6 mm
Max air pressure	8 bar
Compatible with	0007 0018 0030 0055



PVDF+CF



POMc



SS

Damper DAF25

Technical data

Fluid connections	1"
Air connection	8 mm
Max air pressure	8 bar
Compatible with	0060 0090 0100 - 0120



PVDF+CF



POMc

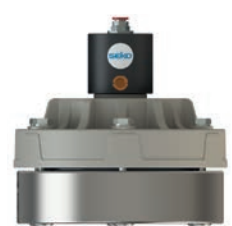

SS

DosingPump.ir

Damper DAF40

Technical data

Fluid connections	1"1/2
Air connection	10 mm
Max air pressure	8 bar
Compatible with	0160 0170 - 0171 0250 - 0252 0400

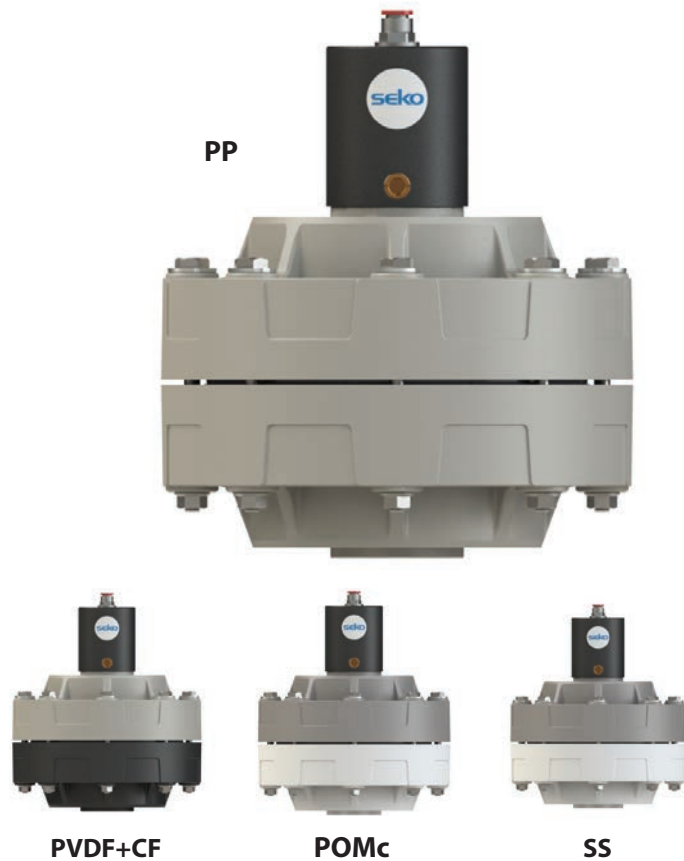

Damper DAF50

Technical data

Fluid connections	2"
Air connection	12 mm
Max air pressure	8 bar
Compatible with	0700 1000

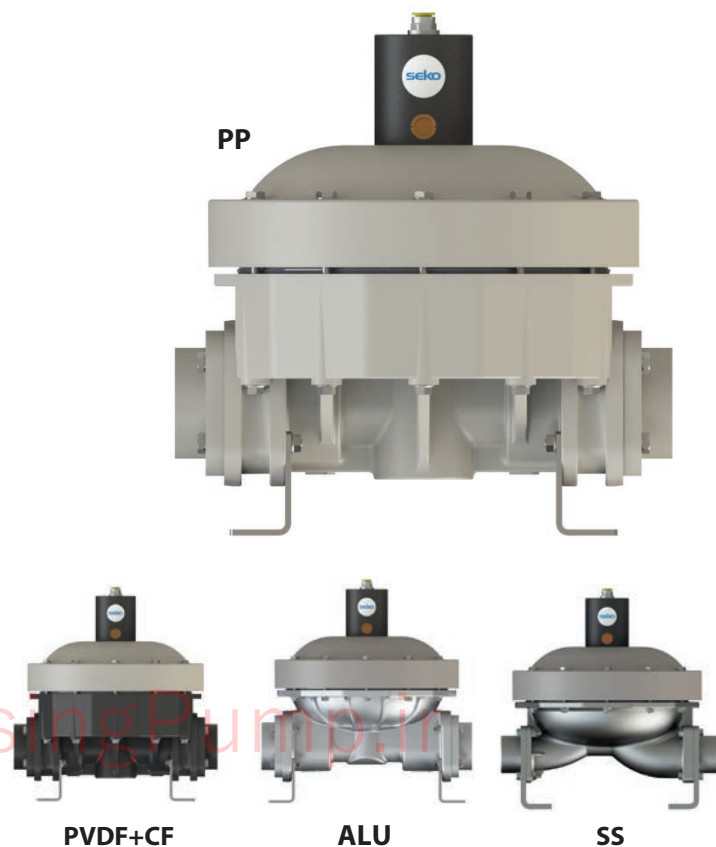





Side Channel Blowers

Vacuum and blast air systems



DosingPump.ir

Product Overview

	Single Impeller	Double Impeller	Triple Impeller
			
Connections	from 1" to 4"	from 1"¼ to 5"	1"¼
Flow Rate	40 – 1,370 m³/h	47 – 2,050 m³/h	170 m³/h
Pressure	70 – 480 mbar	240 – 820 mbar	1050 mbar
Vacuum	-60 – -340 mbar	-200 – -500 mbar	-340 mbar
Motor	Single or 3-Phase	Single or 3-Phase	3-Phase
Noise	46 – 71 dBA	58 – 84 dBA	72 dBA

Blowers

SEKO's range of side channel blowers are an effective solution for air displacement in many applications.

Side channel blowers are the first choice in many automation projects for applications that require large volumes of clean, dry air with low pressures and voids. SEKO's product offering features ease of installation like our other products, with low operating noise levels and low energy consumption.

Side channel compressors and vacuum pumps

Side channel blowers work on the principle of lateral channels working both in suction and compression, and are designed to work in continuous service. The impeller is mounted directly on the motor shaft for frictionless compression and, together with specially shaped housing forms the side channel. SEKO's side channel blowers are constructed of die-cast aluminium, guaranteeing maximum robustness and easy handling. Lubrication is not necessary because there is no contact between static and rotating parts.

The pumped medium is sucked in and compressed which makes it possible to use a side channel blower to generate both a vacuum and blast air.

The rated power of the engine determines the maximum differential pressure of blower. The silencers installed on the sides of the supply and exhaust system ensures quiet operation. Maximum operational reliability, even with high differential is ensured by having the bearings outside the compression chamber.



DosingPump.ir

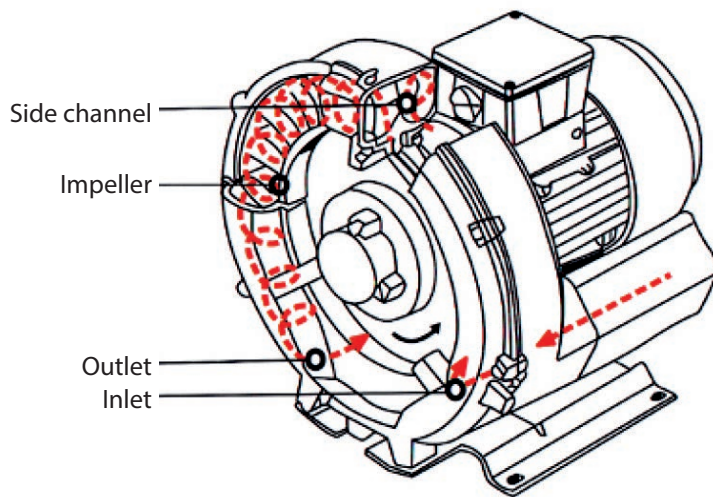

Performance advantages

New variable frequency drive allows maximum performance of a common motor driven unit to be improved by 300%. The precision machine tool cutting, ensures the accuracy and quality, of the blower. All products go through a strict mechanical and electrical performance test, using PROE, UG, CAD and other computer aided design software and motion simulations that test all the design features prior to final manufacture.

All SEKO blowers use 2-pole motors. The range includes both single-phase and three-phase motors. Dual frequency (50/60HZ) and wide voltage can meet almost all voltage levels in all regions of the world, while the external design of the bearing tolerates high working temperatures, and improves the reliability and service life of the blower. The machines are suitable for operation with inverters.

In the moulding for die-casting of aluminium alloys, the machining of completed parts in the cutting process guarantees an improvement in terms of precision compared to traditional technologies. The design of the impeller improves the overall performance of the machine, while its IP55 protection class (class F insulation) makes it suitable for applications all over the world.



Operating principle

The impellers are mounted directly on the motor shaft for non-contact, frictionless compression. Maximum operational reliability, even at high differential, is ensured by the arrangement of the bearings outside the compression chamber.

The gas is taken in through the inlet. As it enters the side channel, the rotating impeller imparts velocity to the gas in the direction of rotation. Centrifugal force in the impeller blades accelerates the gas outward and pressure increases. Every rotation adds kinetic energy.

This results in the further increase of pressure along the side channel. The side channel narrows at the rotor, sweeping the gas off the impeller blades and discharging it through the outlet silencer where it exits the side channel blower.

The unique principle of operation and design brings key advantages

- No wearing parts
- No lubrication required
- Minimal maintenance
- Silent operation
- Smooth air flow
- Can be mounted in any direction, with reduced footprint and installation costs



ingPump.ir



Product line

Single Impeller

Connection from 1" to 4"

Flow rate from 40 to 1,370 m³/h

Pressure from 70 to 480 mbar

Vacuum from -60 to -340 mbar

Motor Single or 3-Phase

Noise from 46 to 71 dB A



Double Impeller

Connection from 1 1/4" to 5"

Flow rate from 47 to 2,050 m³/h

Pressure from 240 to 820 mbar

Vacuum from -200 to -500 mbar

Motor Single or 3-Phase

Noise from 58 to 84 dB A



Triple Impeller

Connection 1 1/4"

Flow rate 170 m³/h

Pressure 1,050 mbar

Vacuum -730 mbar

Motor 3-Phase

Noise 72 dB A



Compressors performance selection at 50 hz (2900 rpm)

Solenoid-Driven Pumps

Motor-Driven Pumps

Peristaltic Pumps

AODD Pumps

Blowers

Accessories

Single Impeller Single Stage		Pressure (mbar)																				Noise dB (A)						
		0	50	75	100	125	150	175	200	225	250	275	300	325	350	375	400	425	450	475	500		525	550	600	625	650	
1"	BL010001	kW	0.2	0.2	0.2																					51		
		m ³ /h	40	20	10																							
1 1/4"	BL020001	kW	0.4	0.4	0.4	0.4	0.4																			56		
		m ³ /h	80	58	45	33	12																					
1 1/2"	BL030001	kW	0.55	0.55	0.55	0.55	0.55	0.55																	60			
		m ³ /h	95	72	60	50	37	20																				
1 1/2"	BL040001	kW	0.85	0.85	0.85	0.85	0.85	0.85	1.3	1.3																64		
		m ³ /h	140	112	100	90	70	55	43	30																		
2"	BL050001	kW	1.3	1.3	1.3	1.3	1.3	1.3	1.5	2.2	2.2	2.2	2.2												70			
		m ³ /h	210	180	165	145	125	115	90	75	65	40	25															
2"	BL053001	kW	1.3	1.3	1.3	1.3	1.3	1.3	2.2	2.2	2.2												71					
		m ³ /h	270	230	200	175	150	130	110	85	70																	
2"	BL060001	kW	2.2	2.2	2.2	2.2	2.2	2.2	2.2	2.2	3	3	3	4	4											74		
		m ³ /h	320	290	270	250	230	210	200	180	165	140	120	95	70													
2"	BL063001	kW	3	3	3	3	3	3	3	3	3	3	4	4	4											73		
		m ³ /h	410	350	325	290	255	235	220	185	175	140	125	100														
2 1/2"	BL070001	kW	4	4	4	4	4	4	4	4	5.5	5.5	5.5	5.5	7.5	7.5	7.5	7.5	7.5	7.5								74
		m ³ /h	520	490	470	430	410	395	380	355	330	305	290	255	240	220	200	180	160	130								
2 1/2"	BL073001	kW	4	4	4	4	4	4	5.5	5.5	7.5	7.5	7.5											74				
		m ³ /h	700	620	580	550	520	490	460	430	400	380	350															
4"	BL090001	kW	8.5	8.5	8.5	8.5	8.5	8.5	8.5	8.5	12.5	12.5	15	15	15	15	18.5	18.5	18.5	18.5								79
		m ³ /h	1,050	960	930	890	850	820	780	760	725	680	640	610	580	560	540	510	480	460	440							
4"	BL093001	kW	8.5	8.5	8.5	8.5	12.5	12.5	12.5	12.5	18.5	18.5	18.5	18.5											80			
		m ³ /h	1,350	1,205	1,150	1,100	1,050	950	880	810	740	650	540	400	350													

Double Impeller Double Stage		Pressure (mbar)																				Noise dB (A)							
		0	50	75	100	125	150	175	200	225	250	275	300	325	350	375	400	425	450	475	500		525	550	600	625	650		
1 1/4"	BL320002	kW	0.7	0.7	0.7	0.7	0.7	0.7	0.7	0.7	0.7																61		
		m ³ /h	90	75	70	60	55	50	40	35	30	20																	
1 1/2"	BL420002	kW	1.5	1.5	1.5	1.5	1.5	1.5	1.5	1.5	1.5	1.5	2.2	2.2	2.2	2.2	2.2	2.2								69			
		m ³ /h	150	135	130	125	120	115	100	95	90	85	75	70	60	50	40	30	25	15									
2"	BL520002	kW	3	3	3	3	3	3	3	3	3	3	3	3	3	3	3	3	4	4	4						74		
		m ³ /h	230	220	210	195	185	175	170	165	155	145	135	125	120	110	100	85	80	70	60	50							
2"	BL620002	kW	4	4	4	4	4	4	4	4	4	4	4	4	4	4	4	4	5.5	5.5	5.5	5.5	7.5	7.5				76	
		m ³ /h	340	335	320	310	295	290	280	265	255	245	240	230	225	220	215	200	190	180	170	155	145	140	130				
2 1/2"	BL920002	kW	7.5	7.5	7.5	7.5	7.5	7.5	7.5	7.5	7.5	7.5	7.5	7.5	7.5	7.5	7.5	7.5	11	11	11	11	11	11	15	15			78
		m ³ /h	520	495	480	470	455	440	430	420	410	390	380	375	370	360	340	335	330	320	315	300	290	280	270	250	240		

Double Impeller Single Stage		Pressure (mbar)																				Noise dB (A)						
		0	50	75	100	125	150	175	200	225	250	275	300	325	350	375	400	425	450	475	500		525	550	600	625	650	
2"	BL620020	kW	4	4	4	4	4	4	5.5	5.5	5.5																78	
		m ³ /h	510	440	400	360	340	300	280	245	215																	
2 1/2"	BL820020	kW	7.5	7.5	7.5	7.5	7.5	7.5	11	11	11	11	11													78		
		m ³ /h	900	830	790	750	710	675	640	600	560	525	480	440	400													
4"	BL920020	kW	16.5	16.5	16.5	16.5	16.5	16.5	16.5	16.5	16.5	16.5	16.5	16.5	16.5	16.5	20	20	20	20	20	25	25	25				78
		m ³ /h	1,150	1,110	1,090	1,070	1,060	1,030	1,000	980	950	920	900	890	875	860	830	825	800	780	770	750	730	725	710			
4"	BL942020	kW	15	15	15	15	20	20	20	20	25	25														84		
		m ³ /h	1,900	1,800	1,750	1,700	1,630	1,600	1,550	1,500	1,400	1,300	1,250															
5"	BL095020	kW	15	15	15	15	15	15	15	20	20	25														84		
		m ³ /h	2,100	1,900	1,850	1,800	1,750	1,700	1,650	1,600	1,500	1,450	1,300															

Compressors performance selection at 50 hz (2900 rpm)

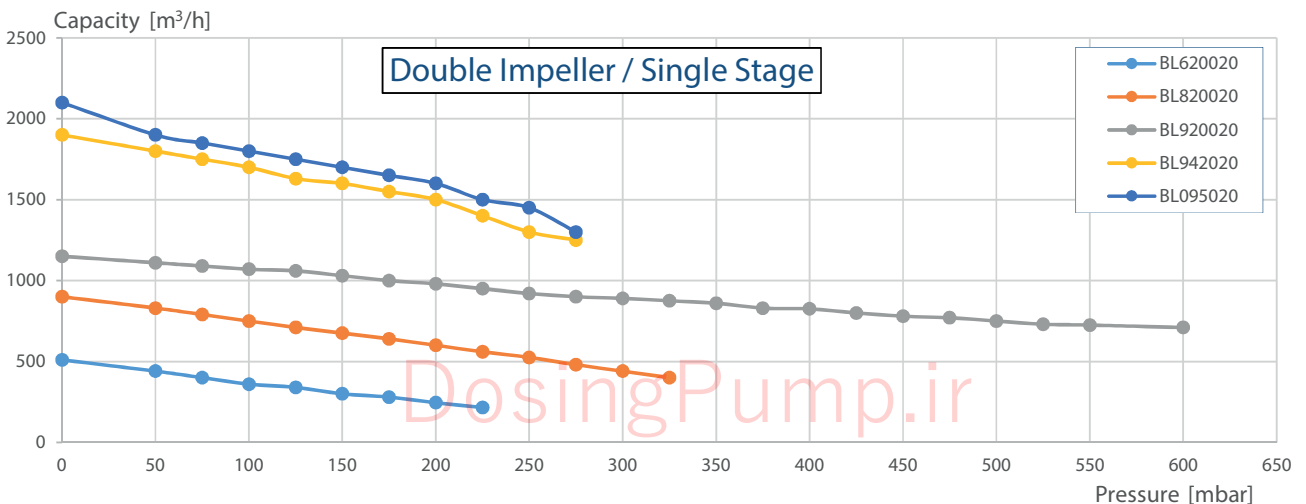
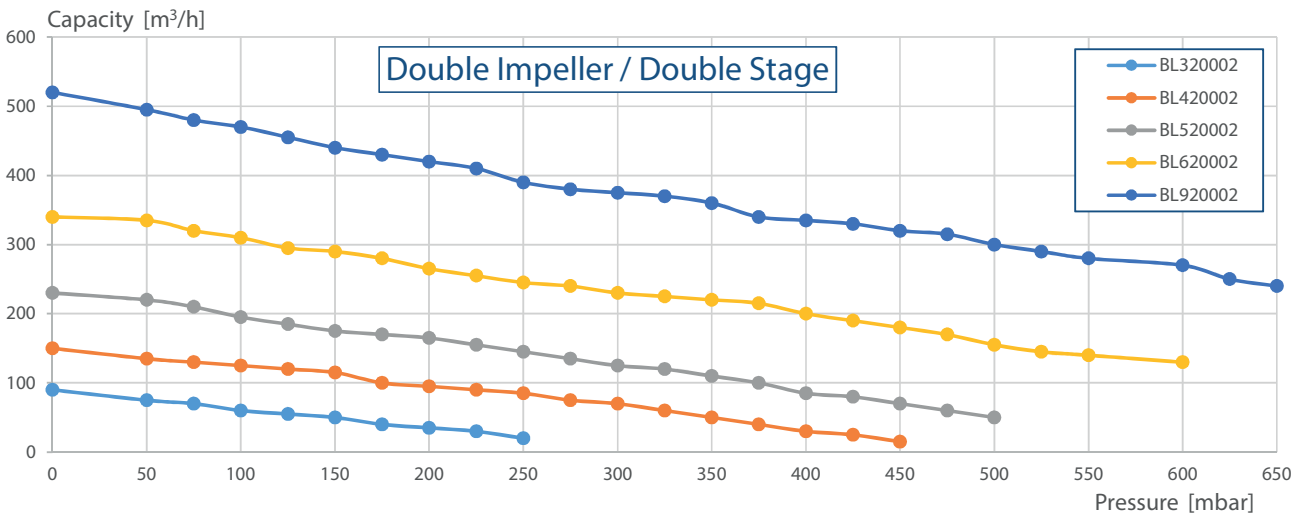
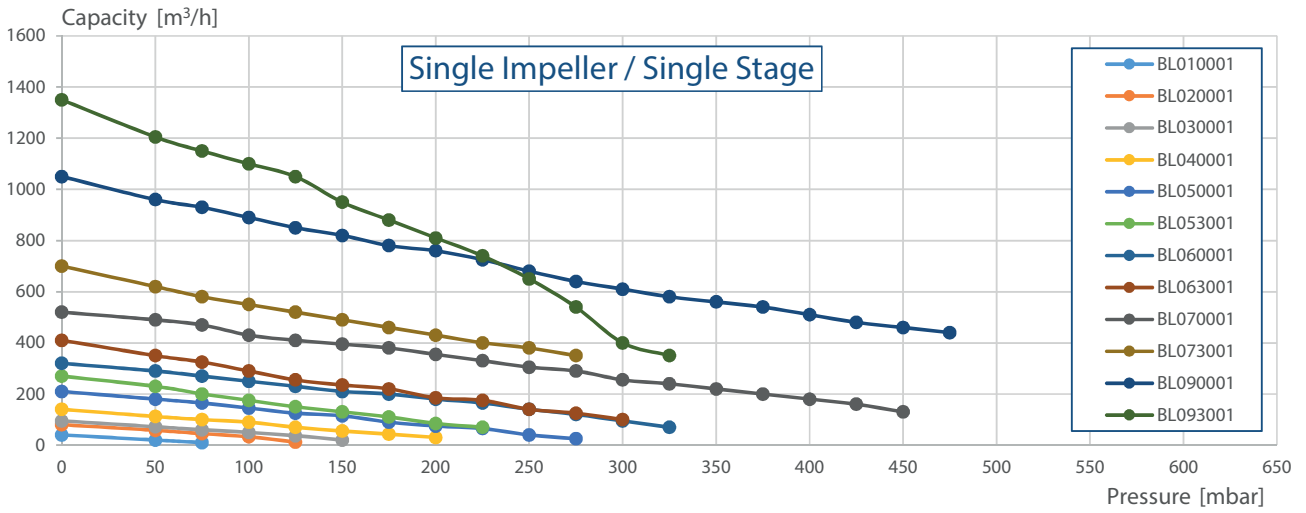

DosingPump.ir

Exhausters performance selection at 50 hz (2900 rpm)

Solenoid-Driven Pumps

Motor-Driven Pumps

Peristaltic Pumps

AODD Pumps

Blowers

Accessories

Single Impeller Single Stage		Pressure (mbar)																		Noise dB (A)						
		0	50	75	100	125	150	175	200	225	250	275	300	325	350	375	400	425	450		475	500	525	550	600	625
1"	BL010001	kW	0.2	0.2																					51	
		m ³ /h	40	15																						
1 1/4"	BL020001	kW	0.4	0.4	0.4	0.4	0.4																			56
		m ³ /h	80	55	45	30	15																			
1 1/4"	BL030001	kW	0.55	0.55	0.55	0.55	0.55	0.55																60		
		m ³ /h	95	70	60	40	28	15																		
1 1/2"	BL040001	kW	0.85	0.85	0.85	0.85	0.85	0.85	0.85														64			
		m ³ /h	140	110	90	75	60	40	25																	
1 1/2"	BL050001	kW	1.3	1.3	1.3	1.3	1.3	1.3	1.5	1.3	2.2												70			
		m ³ /h	210	175	150	130	120	100	80	65	45															
2"	BL053001	kW	1.5	1.5	1.5	1.5	1.5	1.5	2.2	2.2	2.2							71								
		m ³ /h	270	225	195	170	140	120	80	50	25															
2"	BL060001	kW	1.3	1.3	1.3	1.3	1.3	1.3	1.3	3	3	4	4						74							
		m ³ /h	320	280	260	230	210	190	170	150	130	100	80	50												
2"	BL063001	kW	3	3	3	3	3	3	3	3	4	4						73								
		m ³ /h	405	350	310	290	250	215	200	170	130	100														
2 1/2"	BL070001	kW	4	4	4	4	4	4	4	4	5.5	5.5	5.5	5.5	7.5					74						
		m ³ /h	540	470	440	410	380	360	330	300	270	250	210	190	150											
2 1/2"	BL073001	kW	4	4	4	4	4	4	4	5.5	5.5	7.5	7.5					74								
		m ³ /h	700	630	580	550	500	460	425	390	340	290														
4"	BL090001	kW	8.5	8.5	8.5	8.5	8.5	8.5	8.5	8.5	12.5	12.5	15	15	18.5					79						
		m ³ /h	1,050	960	910	860	810	770	720	680	630	590	530	480	430	390										
4"	BL093001	kW	8.5	8.5	8.5	8.5	12.5	12.5	12.5	12.5	18.5	18.5	18.5						80							
		m ³ /h	1,350	1,250	1,190	1,120	1,050	1,000	950	850	750	660	550	400												

Double Impeller Double Stage		Pressure (mbar)																		Noise dB (A)							
		0	50	75	100	125	150	175	200	225	250	275	300	325	350	375	400	425	450		475	500	525	550	600	625	650
1 1/4"	BL320002	kW	0.7	0.7	0.7	0.7	0.7	0.7	0.7	0.7																61	
		m ³ /h	90	70	65	55	45	40	30	20	10																
1 1/2"	BL420002	kW	1.5	1.5	1.5	1.5	1.5	1.5	1.5	1.5	1.5	2.2	2.2												69		
		m ³ /h	150	130	120	110	100	85	80	75	70	50	40	30	20												
2"	BL520002	kW	3	3	3	3	3	3	3	3	3	3	3	3	3	4	4	4						74			
		m ³ /h	230	210	200	185	170	160	150	140	130	120	105	90	80	70	55	30									
2"	BL620002	kW	4	4	4	4	4	4	4	4	4	4	4	4	4	4	5.5	5.5	5.5	5.5						76	
		m ³ /h	310	300	295	280	275	255	250	235	230	200	190	175	160	150	140	125	110	95							
2 1/2"	BL920002	kW	7.5	7.5	7.5	7.5	7.5	7.5	7.5	7.5	7.5	7.5	7.5	7.5	7.5	7.5	7.5	7.5	11	15	15						78
		m ³ /h	520	490	470	455	435	425	405	390	375	360	340	325	310	290	275	255	240	220	200						

Double Impeller Single Stage		Pressure (mbar)																		Noise dB (A)						
		0	50	75	100	125	150	175	200	225	250	275	300	325	350	375	400	425	450		475	500	525	550	600	625
2"	BL620020	kW	4	4	4	4	4	4	5.5	5.5															78	
		m ³ /h	500	450	400	370	320	300	270	200																
2 1/2"	BL820020	kW	7.5	7.5	7.5	7.5	7.5	7.5	7.5	11	11	11	11												78	
		m ³ /h	900	800	755	700	650	600	550	500	450	420	375	350												
4"	BL920020	kW	16.5	16.5	16.5	16.5	16.5	16.5	16.5	16.5	16.5	16.5	16.5	16.5	16.5	16.5	16.5	20	25						78	
		m ³ /h	1,120	1,070	1,050	1,020	1,000	970	950	920	870	860	825	800	775	750	725	700	650	620						
4"	BL942020	kW	15	15	15	15	15	20	20	20	25	25	25												84	
		m ³ /h	1,900	1,800	1,750	1,700	1,600	1,500	1,400	1,350	1,300	1,200	1,100	900	750											
5"	BL095020	kW	15	15	15	15	15	20	20	20	25	25	25												84	
		m ³ /h	2,100	1,950	1,850	1,800	1,700	1,610	1,550	1,450	1,370	1,300	1,200	1,080												

Exhausters performance selection at 50 hz (2900 rpm)

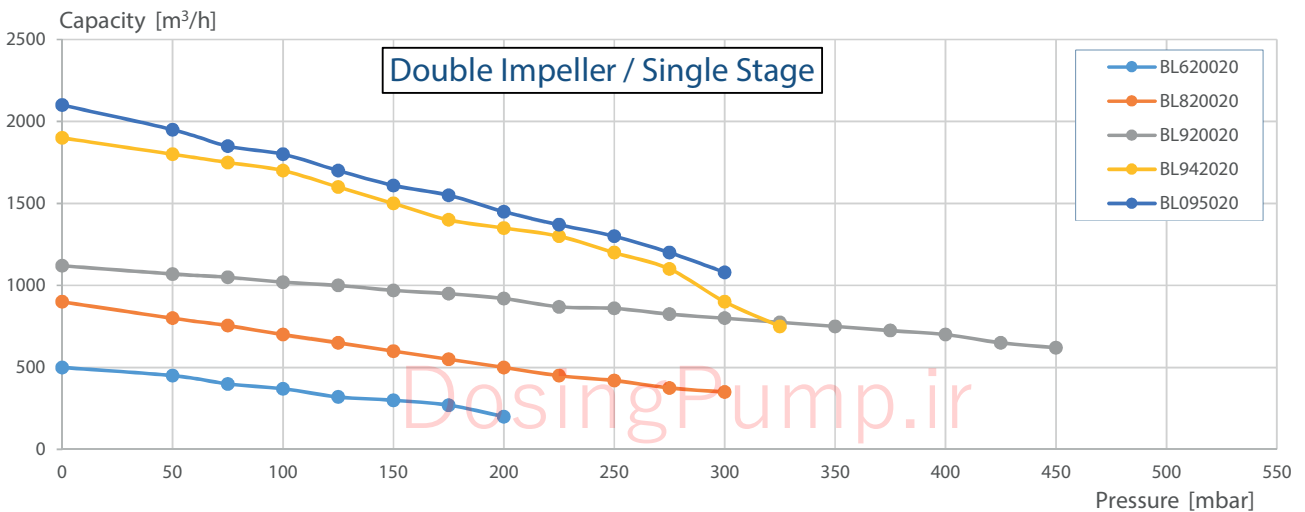
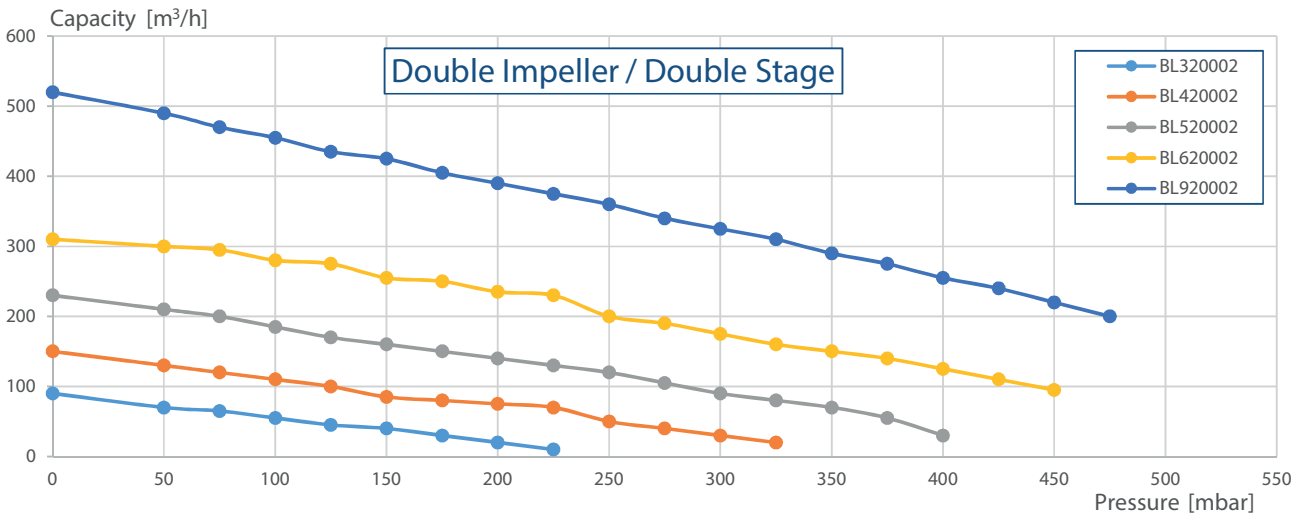
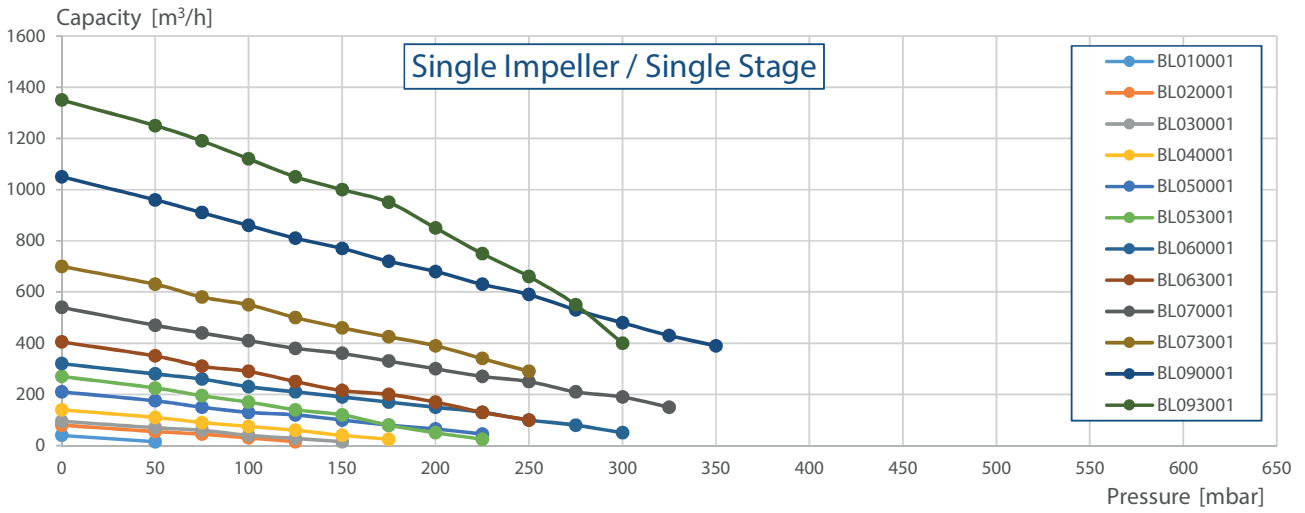

Compressors performance selection at 60 Hz (3500 rpm)

Solenoid-Driven Pumps

Motor-Driven Pumps

Peristaltic Pumps

AODD Pumps

Blowers

Accessories

Single Impeller Single Stage		Pressure (mbar)																		Noise dB (A)							
		0	50	75	100	125	150	175	200	225	250	275	300	325	350	375	400	425	450		475	500	525	550	600	625	650
1"	BL010001	kW	0.23	0.23	0.23																			51			
		m ³ /h	50	30	19																						
1 1/4"	BL020001	kW	0.5	0.5	0.5	0.5	0.5	0.5																			56
		m ³ /h	98	75	68	50	30	20																			
	BL030001	kW	0.62	0.62	0.62	0.62	0.62	0.62	0.62																60		
		m ³ /h	112	88	70	63	50	38	20																		
1 1/2"	BL040001	kW	0.95	0.95	0.95	0.95	0.95	0.95	1.5	1.5	1.5													64			
		m ³ /h	175	140	130	110	90	72	53	40	30																
	BL050001	kW	1.5	1.5	1.5	1.5	1.5	1.5	1.5	1.75	2.55	2.55											70				
		m ³ /h	250	225	200	185	170	150	130	112	96	78															
	BL053001	kW	2.05	2.05	2.05	2.05	2.05	2.05	2.55	2.55	2.55	2.55											71				
		m ³ /h	330	280	260	240	225	210	190	175	160	140															
2"	BL060001	kW	2.55	2.55	2.55	2.55	2.55	2.55	2.55	2.55	3.45	3.45	4.5											74			
		m ³ /h	380	325	310	299	288	262	238	218	200	190	120														
	BL063001	kW	3.45	3.45	3.45	3.45	3.45	3.45	3.45	4.6	4.6	4.6											73				
		m ³ /h	500	440	405	390	350	320	300	290	280	240															
	BL070001	kW	4.6	4.6	4.6	4.6	4.6	4.6	4.6	6.3	6.3	6.3	8.6	8.6	8.6											74	
		m ³ /h	630	590	570	550	540	510	500	475	455	440	395	350	300												
2 1/2"	BL073001	kW	4.6	4.6	4.6	6.3	6.3	6.3	6.3	8.6	8.6	8.6											74				
		m ³ /h	840	760	730	690	670	640	610	580	550	540															
	BL090001	kW	9.8	9.8	9.8	9.8	9.8	9.8	9.8	14.5	14.5	14.5	17.5	17.5	17.5	21.3											79
		m ³ /h	1,250	1,180	1,140	1,100	1,060	1,040	1,010	980	940	910	870	840	810	780											
4"	BL093001	kW	9.8	9.8	14.5	14.5	14.5	14.5	21.3	21.3	21.3	21.3											80				
		m ³ /h	1,600	1,540	1,500	1,470	1,400	1,380	1,300	1,250	1,190	1,120															

Double Impeller Double Stage		Pressure (mbar)																		Noise dB (A)							
		0	50	75	100	125	150	175	200	225	250	275	300	325	350	375	400	425	450		475	500	525	550	600	625	650
1 1/4"	BL320002	kW	0.83	0.83	0.83	0.83	0.83	0.83	0.83	0.83	0.83															61	
		m ³ /h	105	89	81	76	68	59	48	40	36	31															
1 1/2"	BL420002	kW	2.05	2.05	2.05	2.05	2.05	2.05	2.05	2.05	2.05	2.05	2.55	2.55											69		
		m ³ /h	179	170	162	152	148	142	137	130	122	110	89	76	54												
	BL520002	kW	3.45	3.45	3.45	3.45	3.45	3.45	3.45	3.45	3.45	3.45	3.45	4.6	4.6											74	
		m ³ /h	276	260	248	231	223	210	191	184	179	167	147	128	109	80											
2"	BL620002	kW	4.8	4.8	4.8	4.8	4.8	4.8	4.8	4.8	4.8	4.8	4.8	6.3	6.3	6.3											76
		m ³ /h	375	365	355	350	340	335	325	315	310	300	280	260	250	240	230										
2 1/2"	BL920002	kW	8.6	8.6	8.6	8.6	8.6	8.6	8.6	8.6	8.6	8.6	8.6	12.6	12.6	12.6	12.6	12.6	17.3								78
		m ³ /h	630	620	610	600	595	590	580	570	550	540	520	480	475	450	430	410	390	350							

Double Impeller Single Stage		Pressure (mbar)																		Noise dB (A)								
		0	50	75	100	125	150	175	200	225	250	275	300	325	350	375	400	425	450		475	500	525	550	600	625	650	
2"	BL620020	kW	4.6	4.6	4.6	6.3	6.3	6.3	6.3	6.3	6.3	6.3													78			
		m ³ /h	600	540	510	470	450	430	400	380	320	300	210															
2 1/2"	BL820020	kW	8.6	8.6	8.6	8.6	12.6	12.6	12.6	12.6	12.6	12.6	12.6											78				
		m ³ /h	1,050	1,010	980	970	940	910	880	850	810	775	700	625														
	BL920020	kW	19	19	19	19	19	19	19	19	19	19	23	23	29	29	29											78
		m ³ /h	1,310	1,290	1,275	1,255	1,250	1,240	1,220	1,200	1,195	1,175	1,150	1,110	1,070	1,040	1,010	990										
4"	BL942020	kW	17.5	17.5	23	23	23	29	29	29	29															84		
		m ³ /h	2,300	2,250	2,200	2,150	2,050	2,000	1,900	1,800	1,750																	
5"	BL095020	kW	17.5	17.5	17.5	17.5	17.5	23	23	29	29													84				
		m ³ /h	2,500	2,400	2,350	2,300	2,200	2,100	2,050	2,000	1,940																	

Compressors performance selection at 60 Hz (3500 rpm)

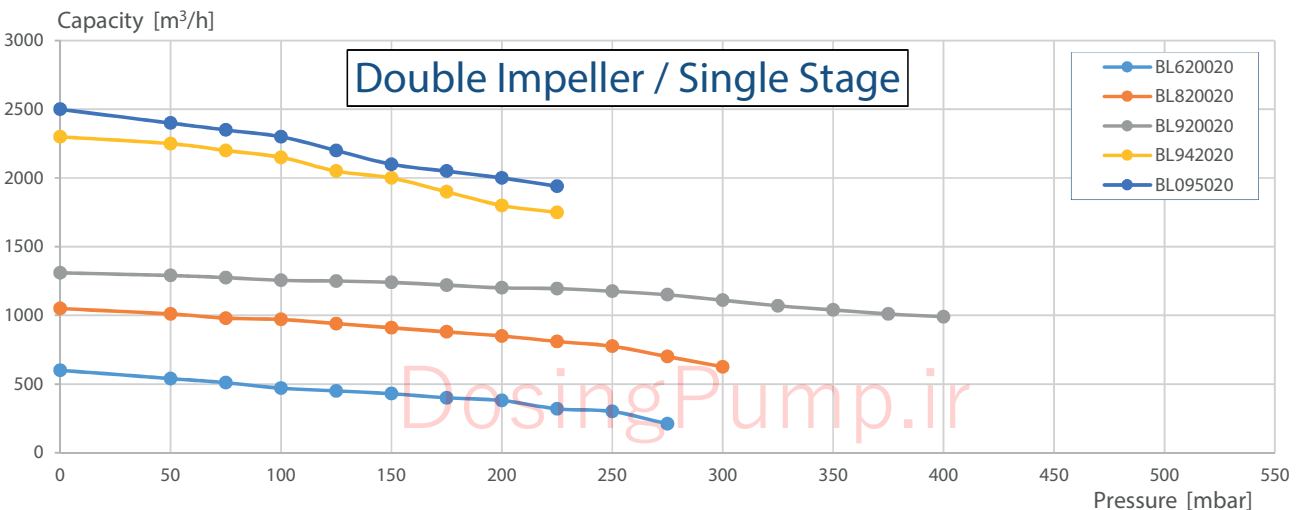
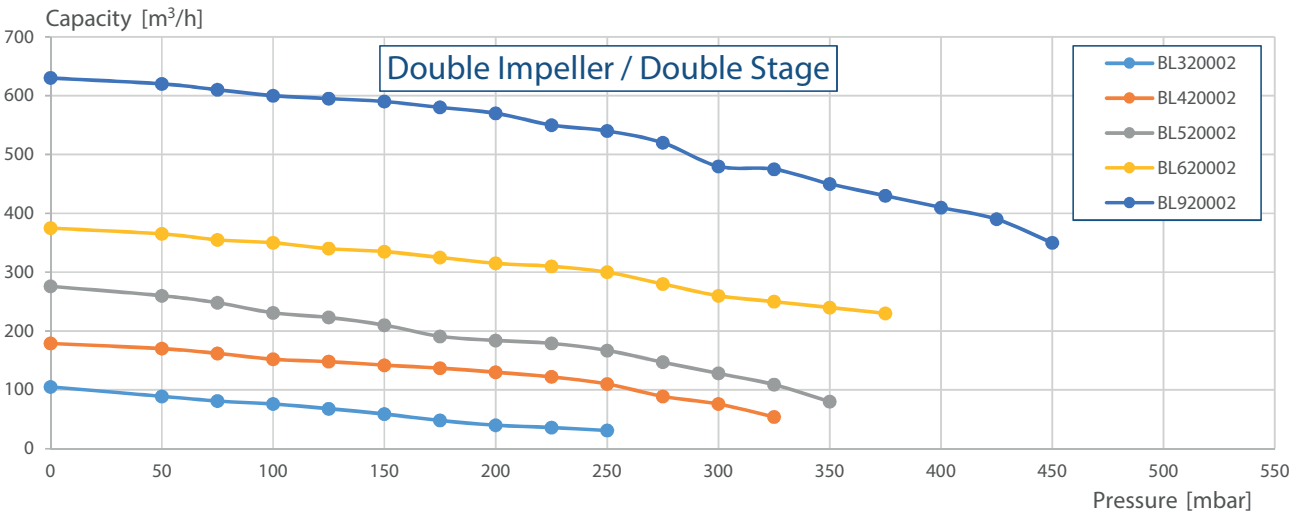
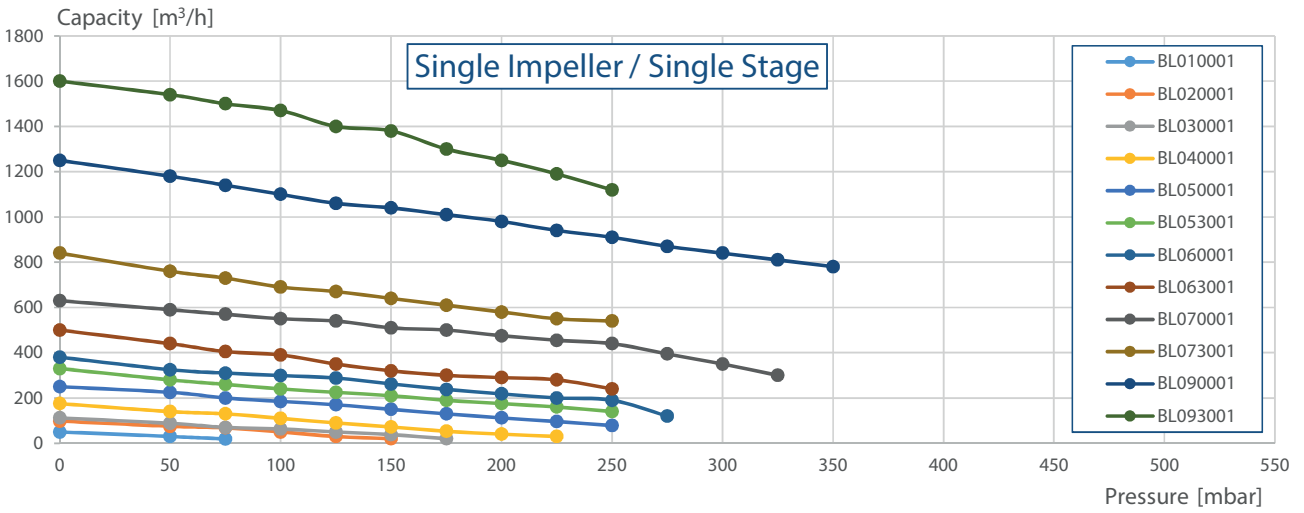

DosingPump.ir

Exhausters performance selection at 60 Hz (3500 rpm)

Solenoid-Driven Pumps

Motor-Driven Pumps

Peristaltic Pumps

AODD Pumps

Blowers

Accessories

Single Impeller Single Stage		Pressure (mbar)																		Noise dB (A)						
		0	50	75	100	125	150	175	200	225	250	275	300	325	350	375	400	425	450		475	500	525	550	600	625
1"	BL010001	kW	0.23	0.23	0.23																			51		
		m ³ /h	50	26	9																					
1 1/4"	BL020001	kW	0.5	0.5	0.5	0.5	0.5	0.5																	56	
		m ³ /h	98	75	62	40	30	20																		
1 1/2"	BL030001	kW	0.62	0.62	0.62	0.62	0.62	0.62	0.62															60		
		m ³ /h	112	88	70	60	40	30	9																	
1 1/2"	BL040001	kW	0.95	0.95	0.95	0.95	0.95	0.95	1.5	1.5	1.5														64	
		m ³ /h	175	132	124	102	80	60	41	35	20															
2"	BL050001	kW	1.5	1.5	1.5	1.5	1.5	1.5	1.5	1.75	2.55	2.55													70	
		m ³ /h	250	220	190	176	152	131	120	92	65	49														
2"	BL053001	kW	2.05	2.05	2.05	2.05	2.05	2.05	2.05	2.55	2.55	2.55											71			
		m ³ /h	330	280	260	230	210	175	150	125	90	70														
2"	BL060001	kW	2.55	2.55	2.55	2.55	2.55	2.55	2.55	2.55	3.45	3.45	4.6											74		
		m ³ /h	380	320	302	291	274	246	223	200	180	153	100													
2"	BL063001	kW	3.45	3.45	3.45	3.45	3.45	3.45	3.45	3.45	4.6	4.6											73			
		m ³ /h	500	430	400	380	350	305	280	250	205	190														
2 1/2"	BL070001	kW	4.6	4.6	4.6	4.6	4.6	4.6	6.3	6.3	6.3	6.3	8.6											74		
		m ³ /h	630	590	560	545	525	500	475	445	420	380	305													
2 1/2"	BL073001	kW	4.6	4.6	4.6	6.3	6.3	6.3	6.3	8.6	8.6	8.6											74			
		m ³ /h	830	750	725	690	650	610	575	550	500	450														
4"	BL090001	kW	9.8	9.8	9.8	9.8	9.8	9.8	9.8	14.5	14.5	14.5	17.5	17.5	21.3											79
		m ³ /h	1,250	1,150	1,100	1,050	1,020	990	960	930	870	830	730	640	540											
4"	BL093001	kW	9.8	9.8	9.8	14.5	14.5	14.5	14.5	21.3	21.3	21.3	21.3											80		
		m ³ /h	1,600	1,520	1,450	1,400	1,320	1,280	1,200	1,110	1,040	950	790													

Double Impeller Double Stage		Pressure (mbar)																		Noise dB (A)							
		0	50	75	100	125	150	175	200	225	250	275	300	325	350	375	400	425	450		475	500	525	550	600	625	650
1 1/4"	BL320002	kW	0.83	0.83	0.83	0.83	0.83	0.83	0.83	0.83	0.83														61		
		m ³ /h	105	91	78	70	60	52	40	31	28	20															
1 1/2"	BL420002	kW	2.05	2.05	2.05	2.05	2.05	2.05	2.05	2.05	2.05	2.05	2.55												69		
		m ³ /h	179	160	148	140	132	127	100	92	82	63	49	23													
2"	BL520002	kW	3.45	3.45	3.45	3.45	3.45	3.45	3.45	3.45	3.45	3.45	3.45	4.6											74		
		m ³ /h	276	268	250	225	210	198	188	176	161	142	121	80	50												
2"	BL620002	kW	4.8	4.8	4.8	4.8	4.8	4.8	4.8	4.8	4.8	4.8	4.8	6.3											76		
		m ³ /h	390	375	360	350	340	330	320	305	290	270	260	240	210	180											
2 1/2"	BL920002	kW	8.6	8.6	8.6	8.6	8.6	8.6	8.6	8.6	8.6	8.6	8.6	12.6	12.6	17.3											78
		m ³ /h	630	600	580	575	570	555	540	530	530	490	450	420	375	340	300										

Double Impeller Single Stage		Pressure (mbar)																		Noise dB (A)						
		0	50	75	100	125	150	175	200	225	250	275	300	325	350	375	400	425	450		475	500	525	550	600	625
2"	BL620020	kW	4.6	4.6	4.6	4.6	4.6	6.3	6.3	6.3	6.3														78	
		m ³ /h	600	550	500	470	450	430	400	310	290	250														
2 1/2"	BL820020	kW	8.6	8.6	8.6	8.6	8.6	12.6	12.6	12.6	12.6													78		
		m ³ /h	1,050	960	920	880	840	800	760	720	675	640	550													
4"	BL920020	kW	19	19	19	19	19	19	19	19	19	19	23	23	29											78
		m ³ /h	1,320	1,260	1,240	1,220	1,190	1,170	1,140	1,120	1,090	1,070	1,040	980	940	890										
4"	BL942020	kW	17.5	17.5	17.5	17.5	17.5	23	23	23	23	29													84	
		m ³ /h	2,300	2,200	2,100	2,000	1,950	1,850	1,800	1,700	1,650	1,550														
5"	BL095020	kW	17.5	17.5	17.5	17.5	17.5	23	23	23	29	29	29													84
		m ³ /h	2,500	2,380	2,320	2,250	2,250	2,100	2,050	2,000	1,940	1,860	1,730													

Exhausters performance selection at 60 Hz (3500 rpm)

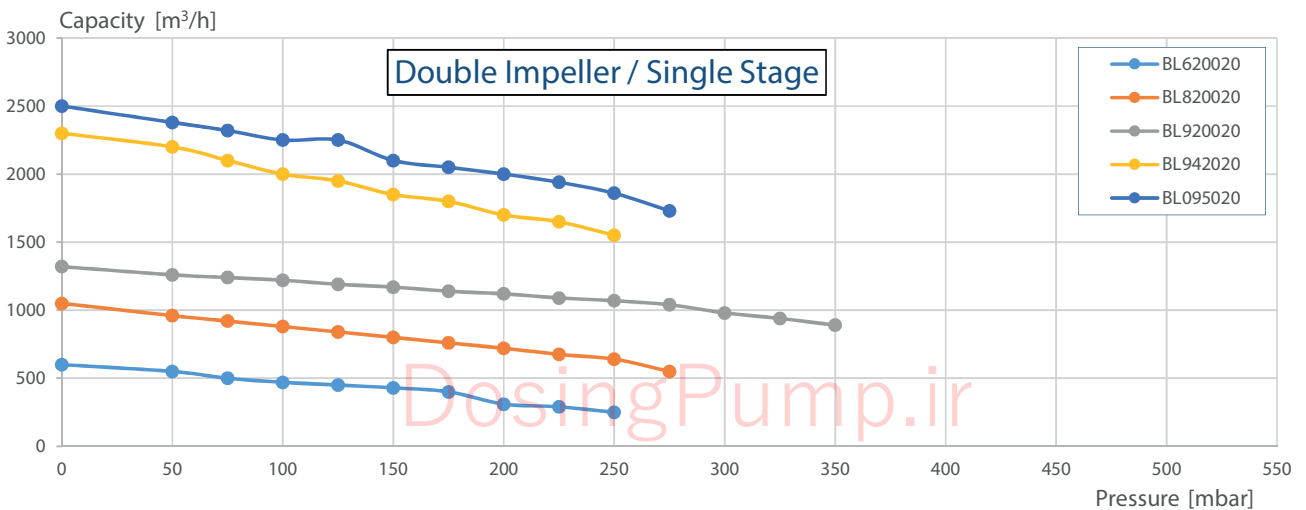
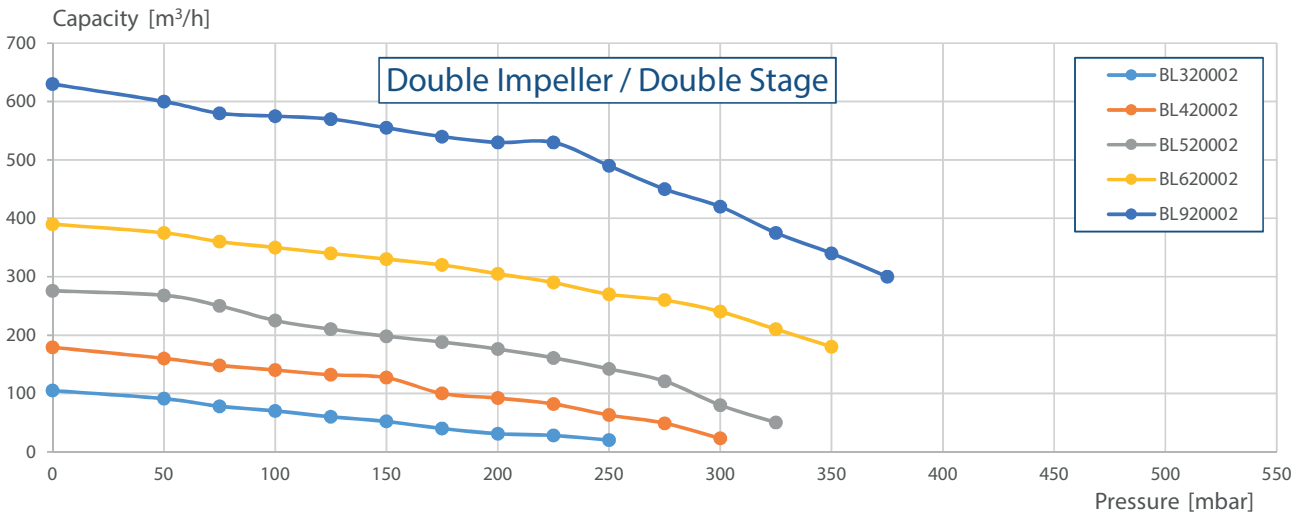
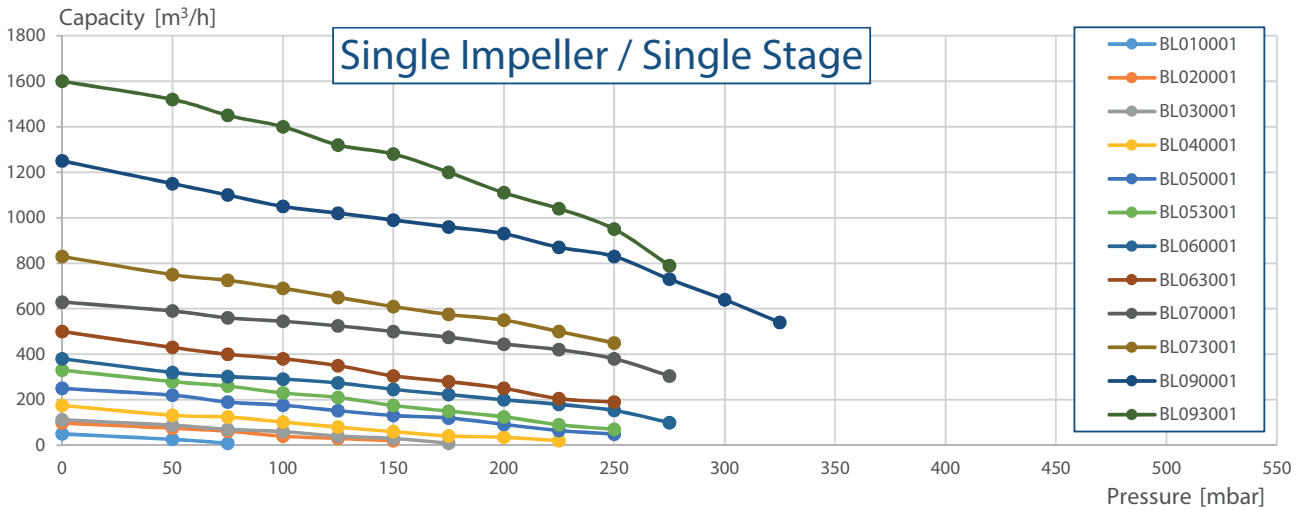

DosingPump.ir

Compressors HP performance selection at 50 Hz (2900 rpm)

Solenoid-Driven Pumps

Motor-Driven Pumps

Peristaltic Pumps

AODD Pumps

Blowers

Accessories

Single Impeller Single Stage		Pressure (mbar)																			Noise dB (A)							
		0	100	200	225	250	275	300	325	350	375	400	450	500	550	600	650	700	750	800		850	900	950	1,000	1,050	1,100	
BL024001	kW	0.55	0.55	0.55	0.55	0.55	0.55	0.55																				57
	m ³ /h	50	30	25	20	15	10	10																				
BL034001	kW	0.55	0.55	0.55	0.55	0.55	0.81	0.81																				57
	m ³ /h	65	50	35	30	25	20	20																				
1"¼ BL034001	kW	1.1	1.1	1.1	1.1	1.1	1.1	1.1	1.1	1.1	1.1																58	
	m ³ /h	95	70	45	40	35	30	26	23	20	15																	
BL054001	kW	1.6	1.6	1.6	1.6	1.6	1.6	1.6	1.6	1.6	2.2	2.2															64	
	m ³ /h	120	95	75	70	65	60	55	45	40	30	30	25															
BL064001	kW	2.2	2.2	2.2	2.2	2.2	2.2	2.2	2.2	2.2	3.3	3.3	3.3														64	
	m ³ /h	160	130	105	95	90	85	80	75	70	65	55	40															

Double Impeller Double Stage		Pressure (mbar)																			Noise dB (A)							
		0	100	200	225	250	275	300	325	350	375	400	450	500	550	600	650	700	750	800		850	900	950	1,000	1,050	1,100	
BL224002	kW	0.81	0.81	0.81	0.81	0.81	0.81	0.81	0.81	0.81	0.81	0.81	1.6	1.6	1.6	1.6	1.6											58
	m ³ /h	50	40	35	30	25	23	23	23	21	20	18	15	10	9	8	5											
BL324002	kW	1.1	1.1	1.1	1.1	1.1	1.1	1.1	1.1	1.1	1.1	1.1	1.6	1.6													59	
	m ³ /h	65	50	45	40	35	33	30	28	26	25	23	22	20	15													
1"¼ BL424002	kW	1.6	1.6	1.6	1.6	1.6	1.6	1.6	1.6	1.6	1.6	1.6	3.3	3.3	3.3	3.3	3.3	3.3									61	
	m ³ /h	85	75	70	65	60	58	55	48	47	46	45	40	35	30	25	20	15	10									
BL524002	kW	2.2	2.2	2.2	2.2	2.2	2.2	2.2	2.2	2.2	2.2	2.2	4.3	4.3	4.3	4.3	4.3	4.3	4.3								64	
	m ³ /h	120	100	95	90	85	75	75	73	70	68	65	60	55	50	45	40	35	30	25								
BL624002	kW	3.3	3.3	3.3	3.3	3.3	3.3	3.3	3.3	3.3	3.3	3.3	3.3	3.3	3.3	5.5	5.5	5.5									67	
	m ³ /h	155	140	130	125	120	120	115	113	108	105	100	90	85	80	75	70	65										

Triple Impeller Triple Stage		Pressure (mbar)																			Noise dB (A)						
		0	100	200	225	250	275	300	325	350	375	400	450	500	550	600	650	700	750	800		850	900	950	1,000	1,050	1,100
1"¼ BL634003	kW	7.5	7.5	7.5	7.5	7.5	7.5	7.5	7.5	7.5	7.5	7.5	7.5	7.5	7.5	7.5	7.5	7.5	7.5	7.5	7.5	7.5	7.5	7.5	7.5	7.5	72
	m ³ /h	160	155	150	145	140	137	135	132	130	125	124	123	122	120	115	113	110	109	108	105	103	102	100			

Compressors HP performance selection at 50 Hz (2900 rpm)

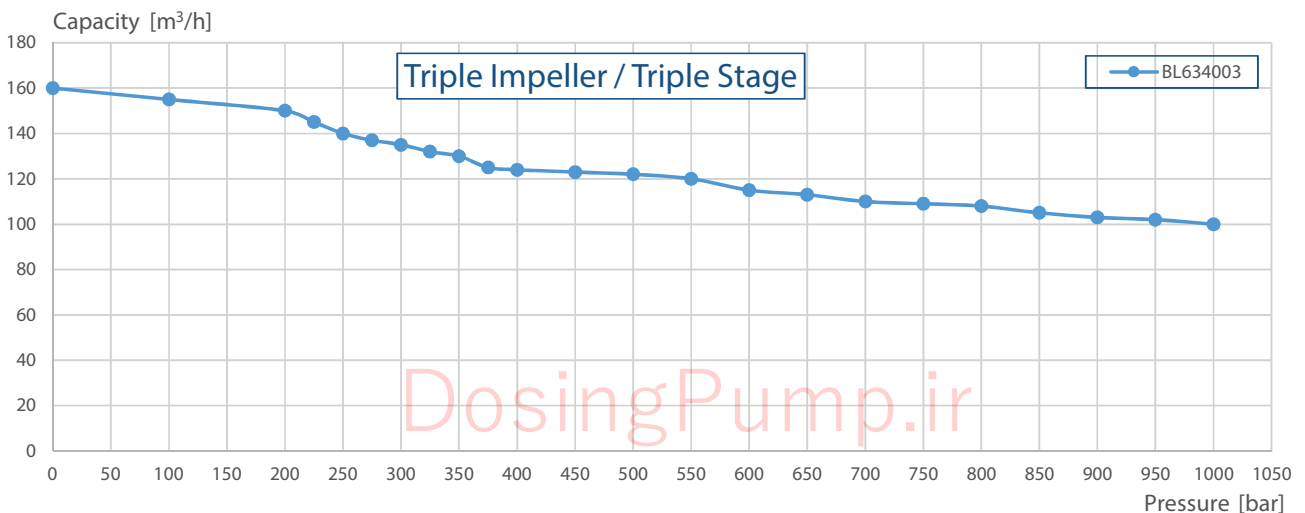
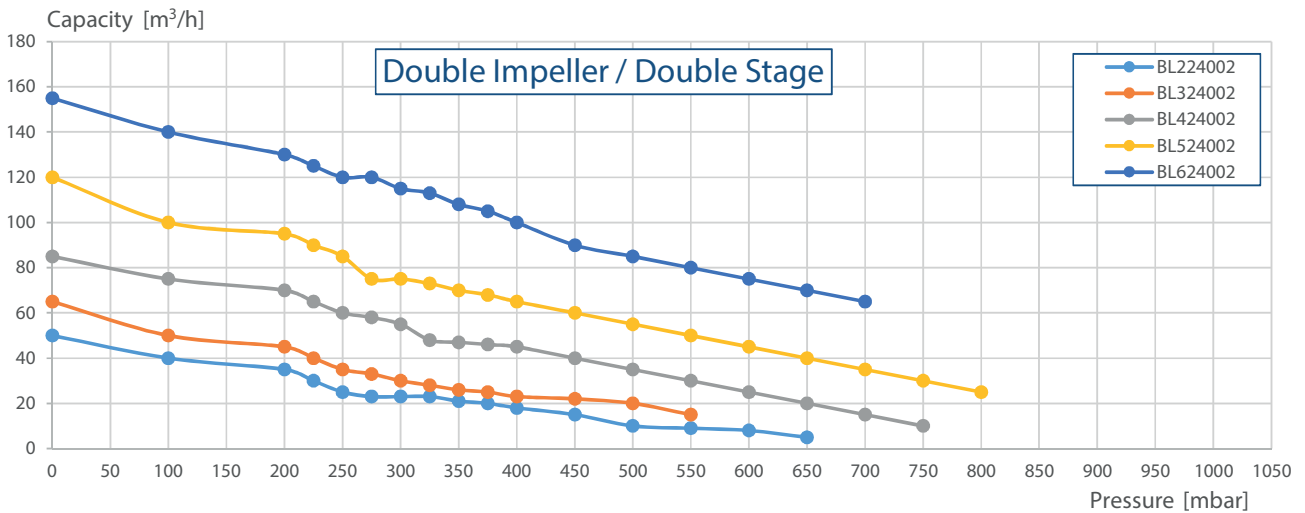
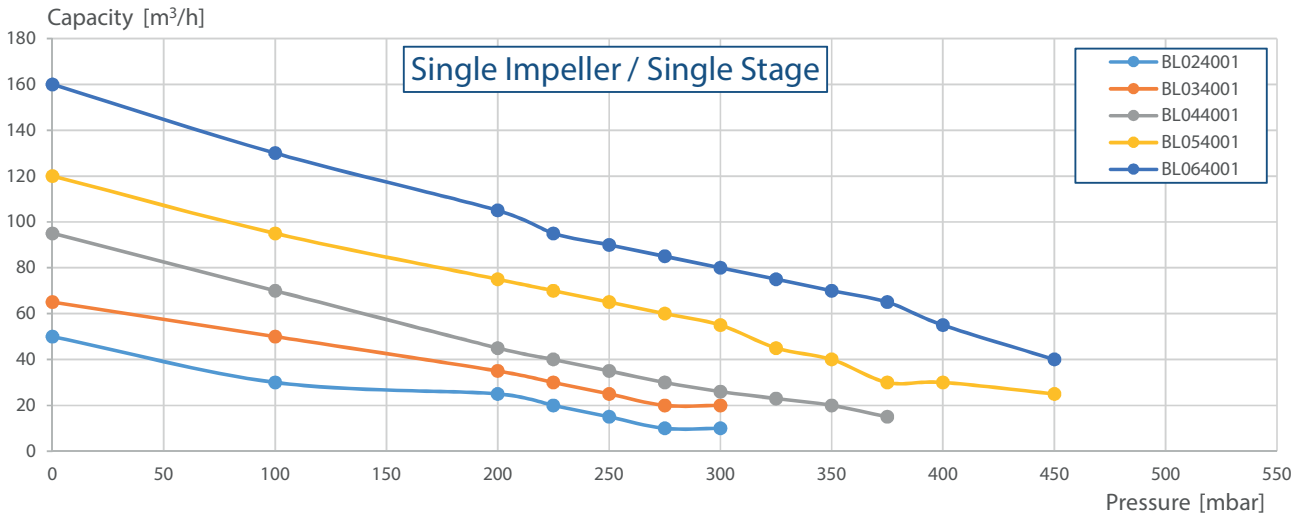

DosingPump.ir

Exhausters HP performance selection at 50 Hz (2900 rpm)

Solenoid-Driven Pumps

Motor-Driven Pumps

Peristaltic Pumps

AODD Pumps

Blowers

Accessories

Single Impeller Single Stage		Pressure (mbar)																			Noise dB (A)						
		0	100	200	225	250	275	300	325	350	375	400	450	500	550	600	650	700	750	800		850	900	950	1,000	1,050	1,100
BL024001	kW	0.55	0.55	0.55	0.55																						
	m ³ /h	50	30	15	10																						
BL034001	kW	0.55	0.55	0.55	0.55	0.81	0.81																				
	m ³ /h	65	45	25	20	15	10																				
1"¼ BL044001	kW	1.1	1.1	1.1	1.1	1.1	1.1	1.1																			
	m ³ /h	90	65	45	40	35	30	20																			
BL054001	kW	1.6	1.6	1.6	1.6	1.6	1.6	1.6																			
	m ³ /h	120	95	70	60	50	45	35																			
BL064001	kW	2.2	2.2	2.2	2.2	2.2	2.2	2.2	2.2																		
	m ³ /h	160	135	100	90	80	70	65	60																		

Double Impeller Double Stage		Pressure (mbar)																			Noise dB (A)						
		0	100	200	225	250	275	300	325	350	375	400	450	500	550	600	650	700	750	800		850	900	950	1,000	1,050	1,100
BL224002	kW	0.81	0.81	0.81	0.81	0.81	0.81	0.81	0.81																		
	m ³ /h	50	40	35	30	28	23	20	15																		
BL324002	kW	1.1	1.1	1.1	1.1	1.1	1.1	1.1	1.1	1.1	1.1	1.6															
	m ³ /h	65	50	45	40	38	33	30	25	20	18	15	10														
1"¼ BL424002	kW	1.6	1.6	1.6	1.6	1.6	1.6	1.6	1.6	1.6	1.6	1.6	3.3														
	m ³ /h	85	75	70	65	60	55	50	50	50	45	35	25	15													
BL524002	kW	2.2	2.2	2.2	2.2	2.2	2.2	2.2	2.2	2.2	2.2	2.2	4.3														
	m ³ /h	120	100	90	85	80	75	70	65	60	55	50	40	25													
BL624002	kW	3.3	3.3	3.3	3.3	3.3	3.3	3.3	3.3	3.3	3.3	3.3	3.3														
	m ³ /h	155	150	130	125	120	110	100	90	85	80	75	65														

Triple Impeller Triple Stage		Pressure (mbar)																			Noise dB (A)						
		0	100	200	225	250	275	300	325	350	375	400	450	500	550	600	650	700	750	800		850	900	950	1,000	1,050	1,100
1"¼ BL634003	kW	7.5	7.5	7.5	7.5	7.5	7.5	7.5	7.5	7.5	7.5	7.5	7.5	7.5	7.5	7.5	7.5	7.5	7.5	7.5	7.5	7.5	7.5	7.5	7.5	7.5	7.5
	m ³ /h	160	150	145	145	140	135	130	130	125	120	115	105	100	90	85	80	75									

Exhausters HP performance selection at 50 Hz (2900 rpm)

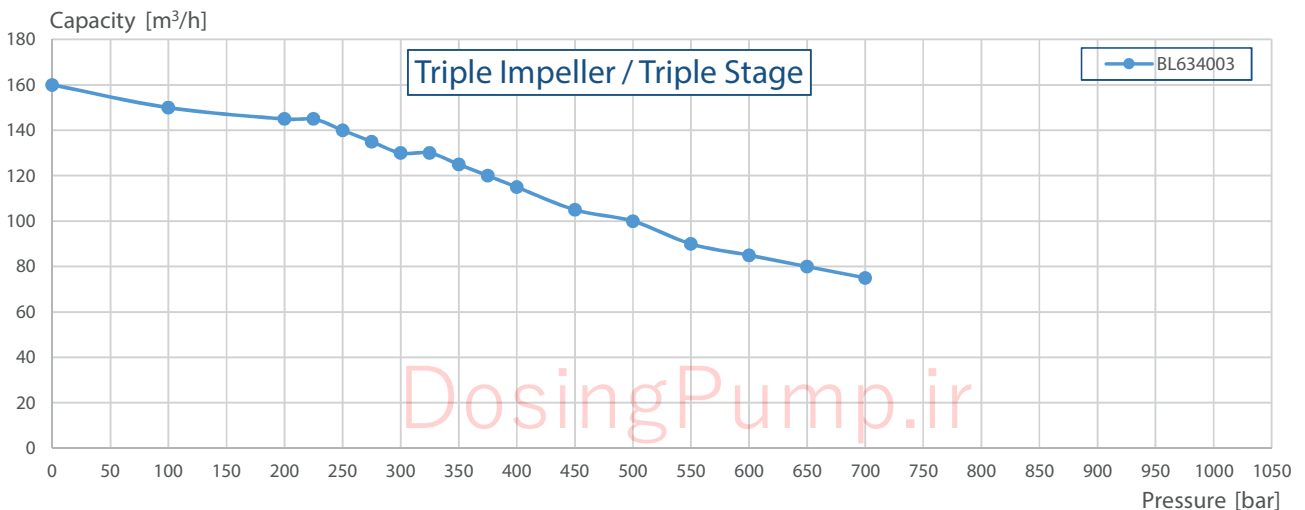
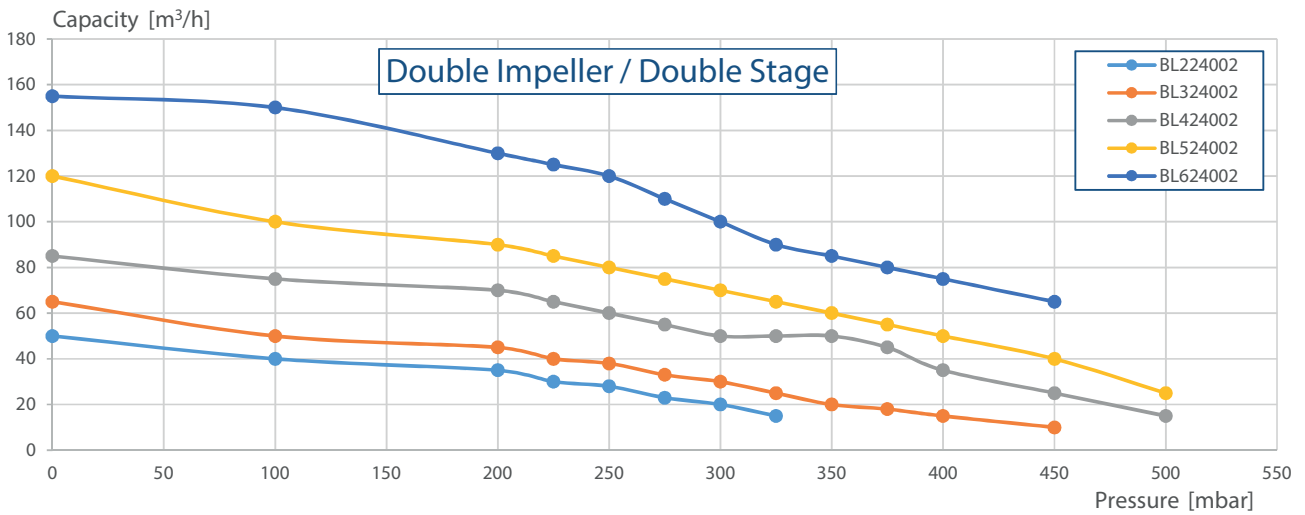
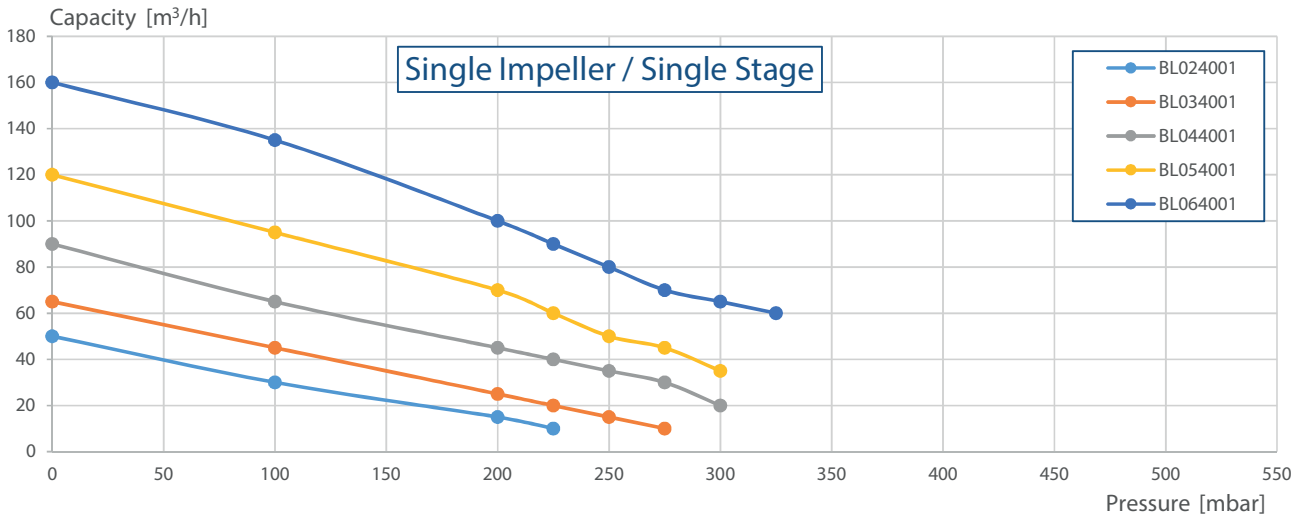

DosingPump.ir

Compressors HP performance selection at 60 Hz (3500 rpm)

Solenoid-Driven Pumps

Motor-Driven Pumps

Peristaltic Pumps

AODD Pumps

Blowers

Accessories

Single Impeller Single Stage		Pressure (mbar)																				Noise dB (A)					
		0	100	200	225	250	275	300	325	350	375	400	450	500	550	600	650	700	750	800	850	900	950	1,000	1,050	1,100	
BL024001	kW	0.63	0.63	0.63	0.63	0.63	0.63	0.63																			62
	m ³ /h	55	40	30	25	20	15	10																			
BL034001	kW	0.63	0.63	0.63	0.63	0.63	0.94	0.94	0.94	0.94																	62
	m ³ /h	75	60	45	42	38	30	28	25	20																	
1"¼ BL044001	kW	1.3	1.3	1.3	1.3	1.3	1.3	1.3	1.3	1.3																	62
	m ³ /h	105	80	65	60	55	45	45	43	40	35																
BL054001	kW	1.75	1.75	1.75	1.75	1.75	1.75	1.75	2.05	2.05	2.05	2.05	2.05	2.05	2.05	2.05	2.05	2.05	2.05	2.05	2.05	2.05	2.05	2.05	2.05	2.05	68
	m ³ /h	145	125	100	90	85	80	75	70	65	60	55	40														
BL064001	kW	2.55	2.55	2.55	2.55	2.55	2.55	2.55	3.8	3.8	3.8	3.8	3.8	3.8	3.8	3.8	3.8	3.8	3.8	3.8	3.8	3.8	3.8	3.8	3.8	3.8	71
	m ³ /h	190	175	145	140	135	130	125	120	115	110	100	80	70	60												

Double Impeller Double Stage		Pressure (mbar)																				Noise dB (A)					
		0	100	200	225	250	275	300	325	350	375	400	450	500	550	600	650	700	750	800	850	900	950	1,000	1,050	1,100	
BL224002	kW	0.94	0.94	0.94	0.94	0.94	0.94	0.94	0.94	0.94	0.94	0.94	0.94	2.05	2.05	2.05	2.05	2.05	2.05	2.05	2.05	2.05	2.05	2.05	2.05	2.05	62
	m ³ /h	55	45	40	38	36	34	30	28	26	24	22	20	18	16	14	12	10	8								
BL324002	kW	1.3	1.3	1.3	1.3	1.3	1.3	1.3	1.3	1.3	1.3	1.3	1.3	2.05	2.05	2.05											63
	m ³ /h	75	65	60	58	56	54	50	48	46	44	42	40	38	35	30											
1"¼ BL424002	kW	2.05	2.05	2.05	2.05	2.05	2.05	2.05	2.05	2.05	2.05	2.05	3.8	3.8	3.8	3.8	3.8	3.8	3.8	3.8	3.8	3.8	3.8	3.8	3.8	3.8	66
	m ³ /h	105	90	80	78	76	74	70	68	66	64	62	58	55	50	45	40	35	33	30							
BL524002	kW	2.55	2.55	2.55	2.55	2.55	2.55	2.55	2.55	2.55	2.55	2.55	4.8	4.8	4.8	4.8	4.8	4.8	4.8	4.8	4.8	4.8	4.8	4.8	4.8	4.8	71
	m ³ /h	145	135	120	115	110	105	100	97	94	90	85	80	75	70	65	60	55	50	45							
BL624002	kW	3.8	3.8	3.8	3.8	3.8	3.8	3.8	3.8	3.8	3.8	3.8	6.3	6.3	6.3	6.3	6.3	6.3	6.3	6.3	6.3	6.3	6.3	6.3	6.3	6.3	72
	m ³ /h	190	180	175	170	165	160	155	148	144	140	138	135	130	125	120	115	110	100	95							

Triple Impeller Triple Stage		Pressure (mbar)																				Noise dB (A)					
		0	100	200	225	250	275	300	325	350	375	400	450	500	550	600	650	700	750	800	850	900	950	1,000	1,050	1,100	
1"¼ BL634003	kW	8.6	8.6	8.6	8.6	8.6	8.6	8.6	8.6	8.6	8.6	8.6	8.6	8.6	8.6	8.6	8.6	8.6	8.6	8.6	8.6	8.6	8.6	8.6	8.6	8.6	72
	m ³ /h	200	190	185	180	175	170	163	158	155	152	150	150	148	145	140	135	130	125	120	118	115	112	110			

Compressors HP performance selection at 60 Hz (3500 rpm)

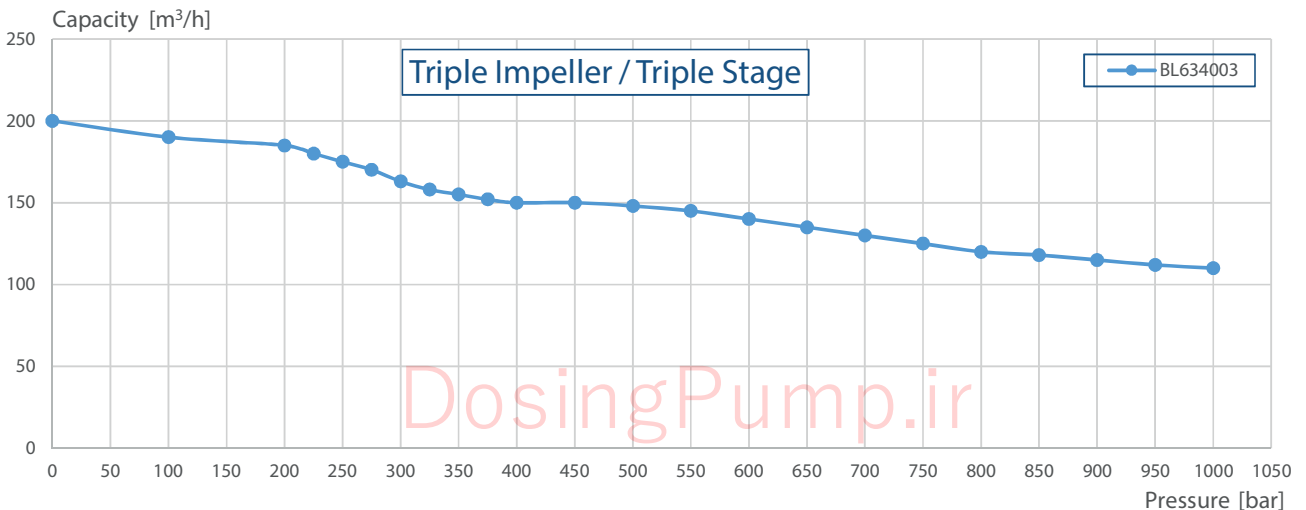
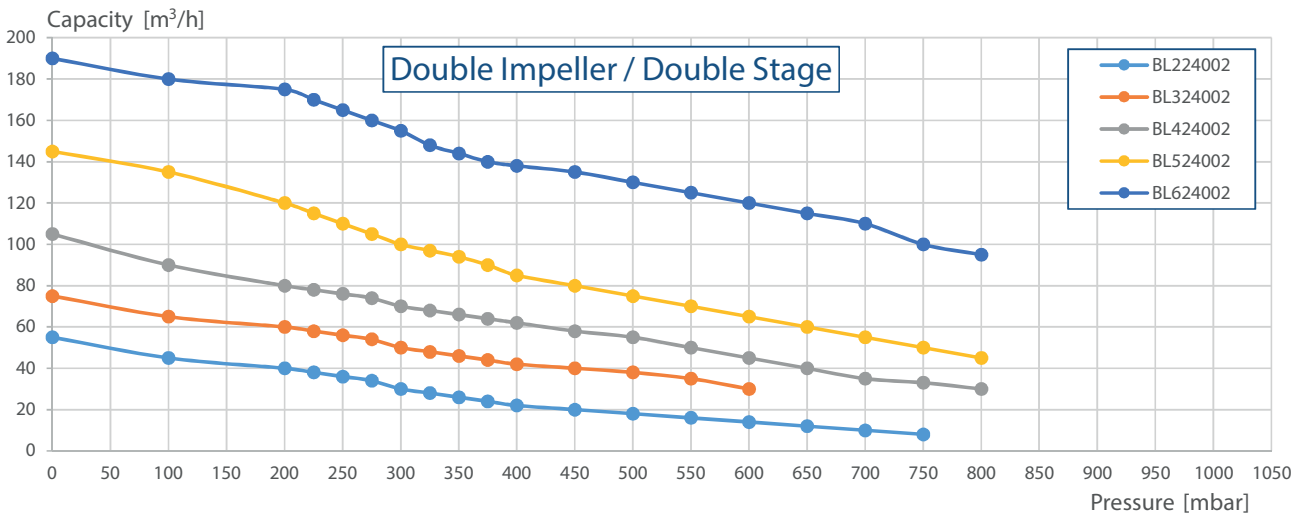
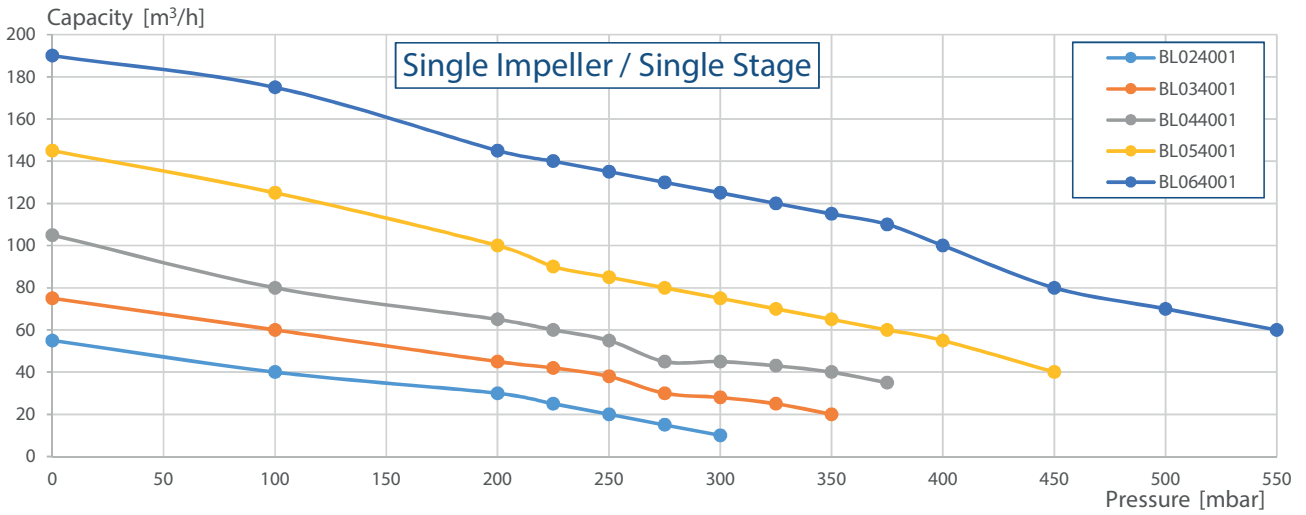

DosingPump.ir

Exhausters HP performance selection at 60 Hz (3500 rpm)

Solenoid-Driven Pumps

Motor-Driven Pumps

Peristaltic Pumps

AODD Pumps

Blowers

Accessories

Single Impeller Single Stage		Pressure (mbar)																			Noise dB (A)						
		0	100	200	225	250	275	300	325	350	375	400	450	500	550	600	650	700	750	800		850	900	950	1,000	1,050	1,100
BL024001	kW	0.63	0.63	0.63	0.63	0.63																					
	m ³ /h	55	40	20	15	10																					
BL034001	kW	0.63	0.63	0.63	0.63	0.63	0.94	0.94	0.94																		
	m ³ /h	75	60	40	30	25	20	18	10																		
1"¼ BL044001	kW	1.3	1.3	1.3	1.3	1.3	1.3	1.3	1.3																		
	m ³ /h	105	80	55	45	40	30	25	20																		
BL054001	kW	1.75	1.75	1.75	1.75	1.75	1.75	1.75	2.05																		
	m ³ /h	145	120	80	70	60	50	45	35	25																	
BL064001	kW	2.55	2.55	2.55	2.55	2.55	2.55	2.55	2.55	3.8																	
	m ³ /h	190	160	125	115	100	95	80	70	60	40																

Double Impeller Double Stage		Pressure (mbar)																			Noise dB (A)						
		0	100	200	225	250	275	300	325	350	375	400	450	500	550	600	650	700	750	800		850	900	950	1,000	1,050	1,100
BL224002	kW	0.94	0.94	0.94	0.94	0.94	0.94	0.94	0.94	0.94	0.94	0.94	2.05	2.05	2.05												
	m ³ /h	55	45	40	35	30	25	25	22	20	18	15	10	8	5												
BL324002	kW	1.3	1.3	1.3	1.3	1.3	1.3	1.3	1.3	2.05	2.05	2.05	2.05	2.05													
	m ³ /h	75	60	55	50	45	40	37	35	34	30	28	25	20	10												
1"¼ BL424002	kW	2.05	2.05	2.05	2.05	2.05	2.05	2.05	2.05	2.05	2.05	2.05	3.8	3.8													
	m ³ /h	105	90	85	80	75	70	65	60	55	50	45	35	25													
BL524002	kW	2.55	2.55	2.55	2.55	2.55	2.55	2.55	2.55	2.55	2.55	2.55	2.55	4.8													
	m ³ /h	145	125	105	100	95	90	85	80	75	70	60	50	40													
BL624002	kW	3.3	3.3	3.3	3.3	3.3	3.3	3.3	3.3	3.3	3.3	3.3	3.3	3.3													
	m ³ /h	190	175	160	150	140	135	130	125	120	115	110	90														

Triple Impeller Triple Stage		Pressure (mbar)																			Noise dB (A)						
		0	100	200	225	250	275	300	325	350	375	400	450	500	550	600	650	700	750	800		850	900	950	1,000	1,050	1,100
1"¼ BL634003	kW	8.6	8.6	8.6	8.6	8.6	8.6	8.6	8.6	8.6	8.6	8.6	8.6	8.6	8.6	8.6	8.6	8.6	8.6	8.6	8.6	8.6	8.6	8.6	8.6	8.6	8.6
	m ³ /h	200	185	175	170	165	160	155	148	145	140	140	135	125	120	100	85	75									

Exhausters HP performance selection at 60 Hz (3500 rpm)

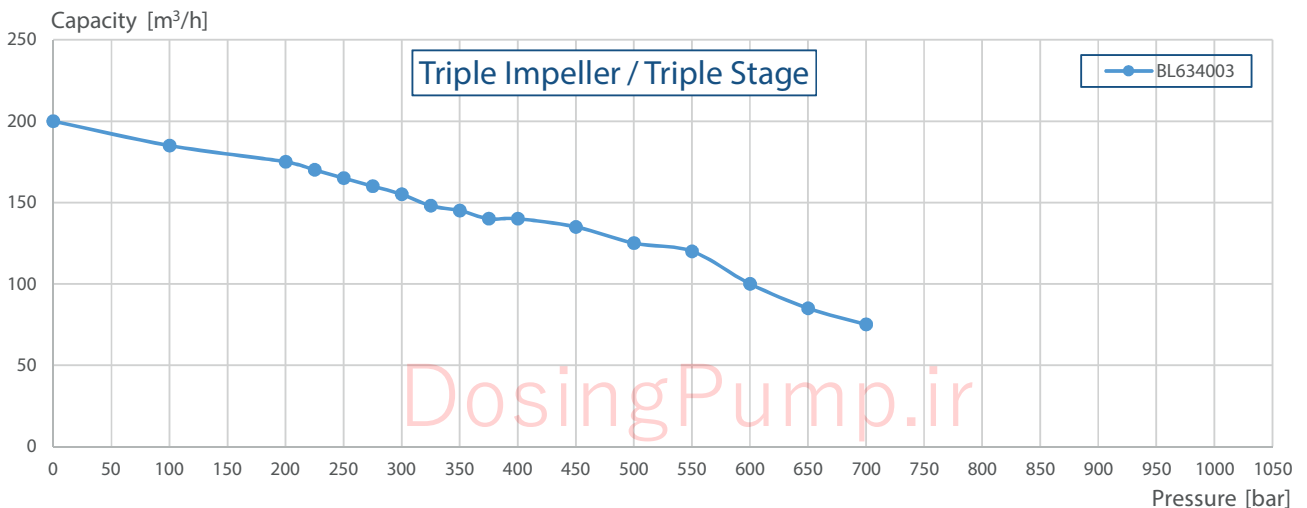
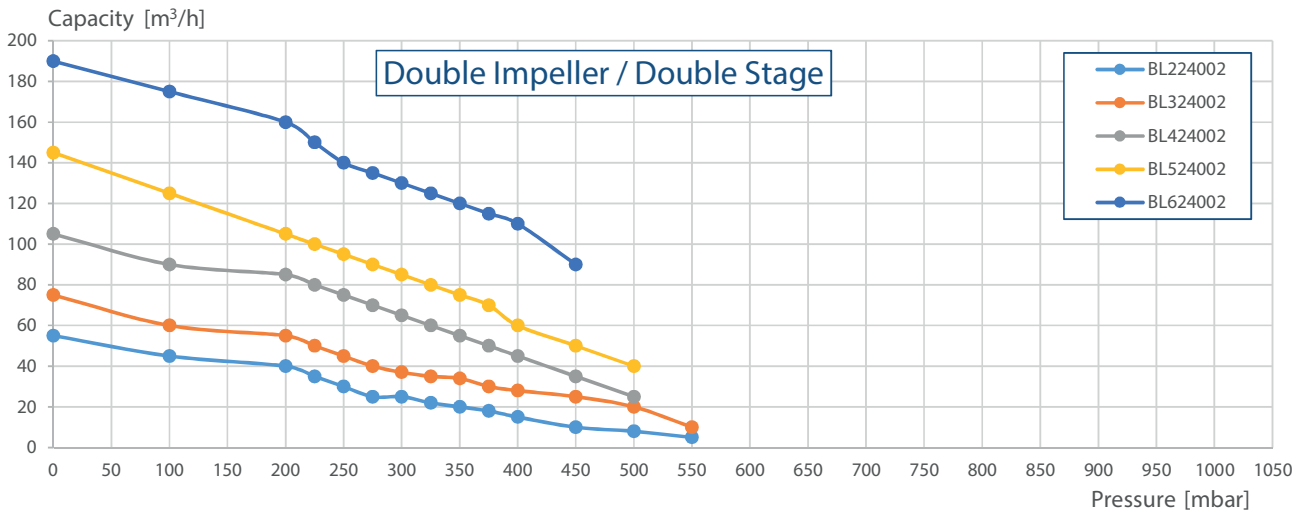
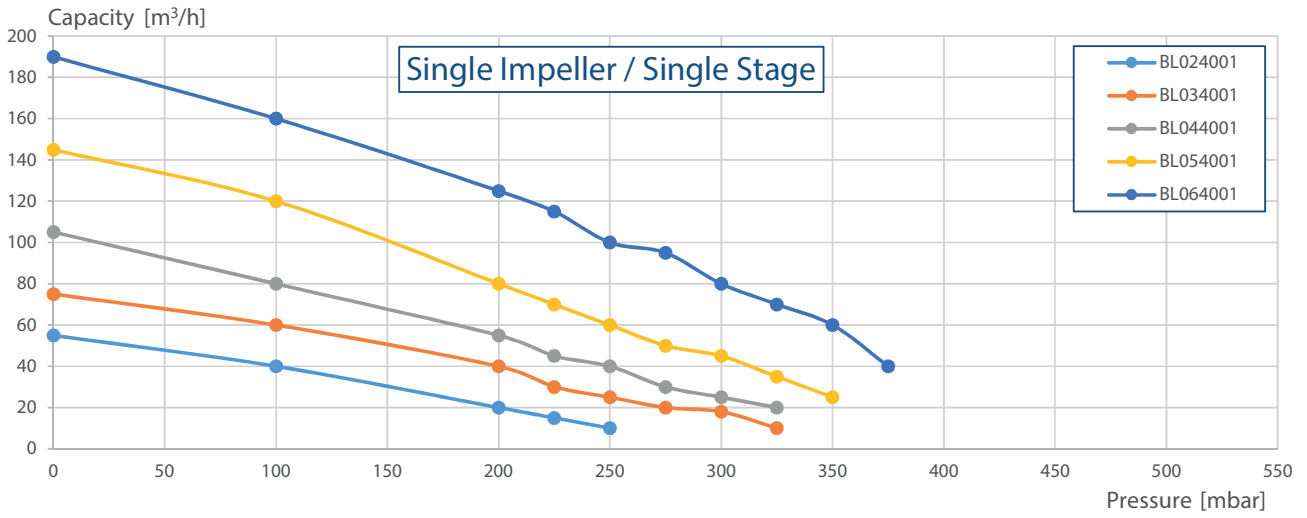

DosingPump.ir



Accessories



DosingPump.ir

Common Accessories

The trouble-free operation of a pump depends on the correct pre-installation analysis specific to the intended application. The choice of accessories and their sizing are critical for the correct performance of a reliable system.

Threaded Water Meter

Series	Size	Pulse/l
TC1		0.1
TH1	from 1/2" to 2"	1
TC0		4



Flanged Water Meter

Series	Size	Pulse/l
FC	from 2" to 6"	100 1,000



Fast Mixers

Shaft	Material
600	
800	SS316
900	PVC
1,100	
Propeller	rpm
90	1400

Slow Mixers

Shaft	Material
600	
800	SS316
900	PVC
1,100	
Propeller	rpm
150	70
220	200

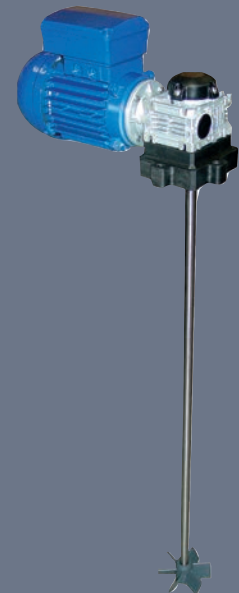

Tanks

Type	Height [mm]	Diameter [Ø mm]
SER-50	465	410
SER-100	650	470
SER-250	870	610
SER-300	965	670
SER-500	1195	760
SER-1000	1223	1,085



Reinforcement

Type	Height [mm]	for Tank
-	-	-
SML-100	610	SER-100
SML-250	820	SER-250
SML-300	960	SER-300
SML-500	1,105	SER-500
SML-1000	1,255	SER-1000

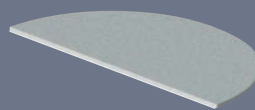

Security Tanks

Type	Height [mm]	Diameter [Ø mm]
-	-	-
T-150	610	550
T-300	820	765
T-400	960	780
T-800	1,105	846
T-1500	1,255	1,235



DosingPump.ir

Solenoid-Driven Pump Accessories

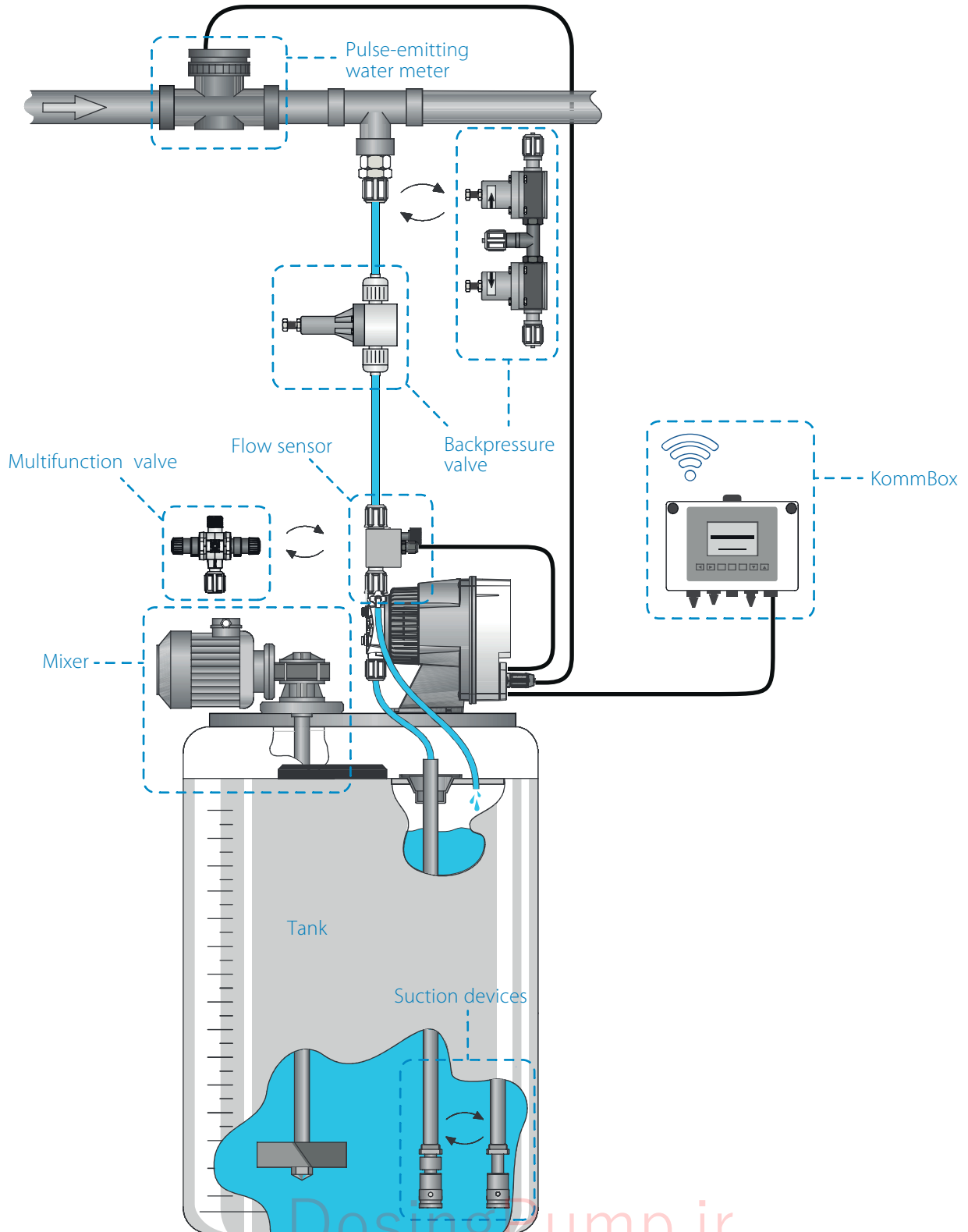

Solenoid-Driven Pumps

Motor-Driven Pumps

Peristaltic Pumps

AODD Pumps

Blowers

Accessories

Solenoid-Driven Pump Accessories

Suction devices					
Type	Length [mm]	Diameter [Ø mm]	Seals	Level	for Tank
PVC suction lance	450	22 (for 4x6 tube)	FKM-B EPDM	YES NO	SER-50
	650				SER-100
	900	SER-250			
	1,050	34 (for 8x12 tube)			SER-300
	1,250	SER-500/1000			

Valves					
Type	Pressure [bar]	Flow rate [l/h]	Material	Seals	Tube
Backpressure	1.5 0.5 - 5	-	PVDF	FKM-B EPDM	4x6
Backpressure	1.5 0.5 - 10	-	PVC	FPM EPDM	4x6 8x12
Backpressure HYC	max 10	50	PVC	FPM EPDM	4x6 8x12
Safety HYS	max 10	50	PVC	FPM EPDM	4x6 8x12
Multiple HYM	max 10	50	PVC	FPM EPDM	4x6 8x12
Multifunction	0 - 18 (safety) 0 - 5 (backpressure)	-	PVDF (diaphragm PTFE)	FKM-B EPDM	4x6 8x12

Communication device					
Type	Power supply	CAN	RS485	Ethernet	Max units connected
Kontrol KommBox	100 - 240Vac 50/60Hz	Communication port	Serial Port for Data Communication	Standard RJ45 Ethernet port	10

Other					
Type	Pressure [bar]	Flow rate [l/h]	Material	Seals	Tube
Flow sensor	1.5 0.5 - 5	-	PVC PVDF PMMA	FKM-B EPDM	4x6 8x12

Motor-Driven Pump Accessories

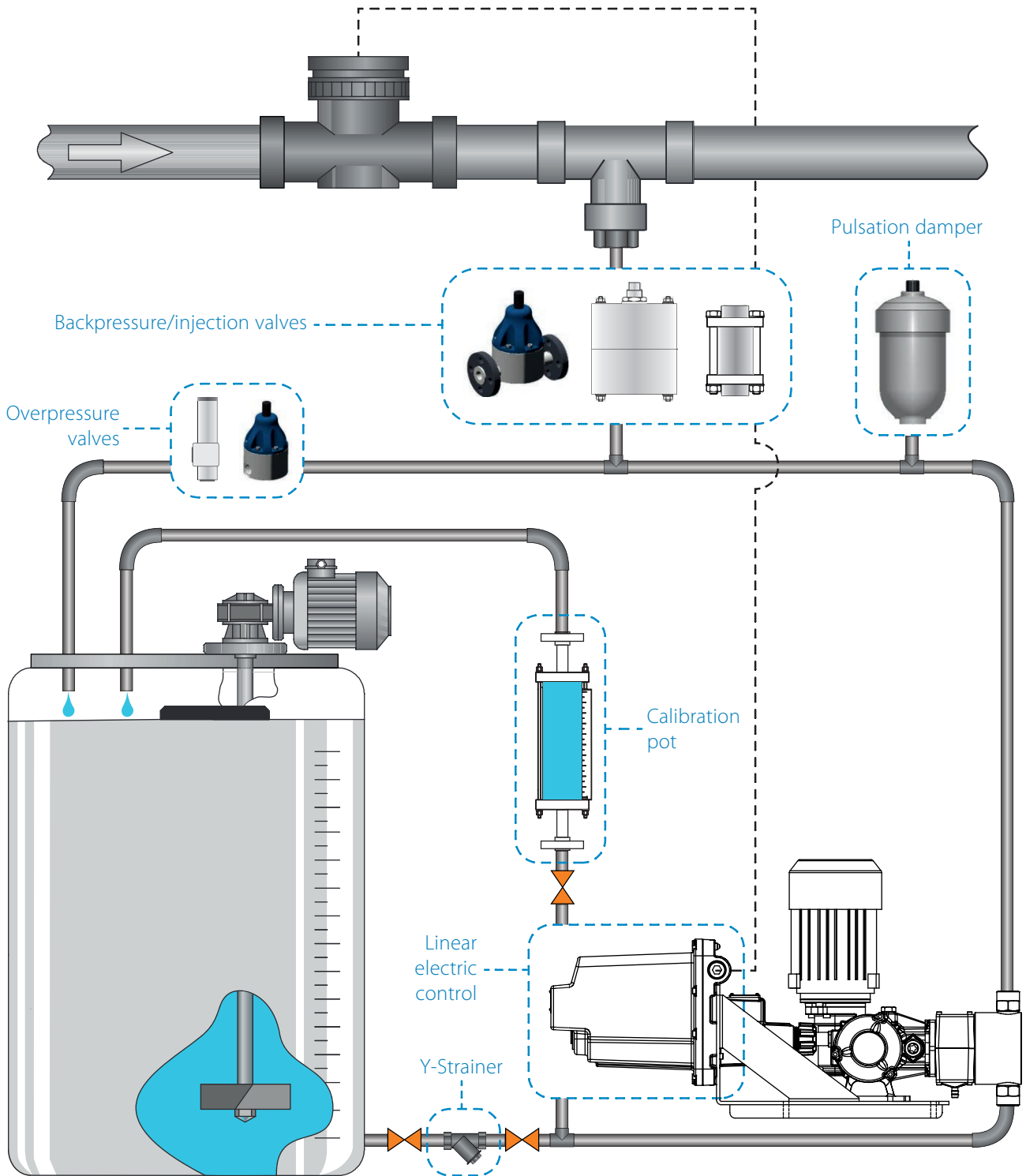

DosingPump.ir

Solenoid-Driven Pumps

Motor-Driven Pumps

Peristaltic Pumps

AODD Pumps

Blowers

Accessories

Motor-Driven Pump Accessories

Backpressure valve

Model	Max Flow Rate [l/h]	Setting Pressure [bar]	Code	Contact parts
VSM-S (SS316L)	300	0 - 5	VSM1S03005_A	SS316L/PTFE
	800		VSM2S08005_A	
	1,500		VSM3S15005_A	

Backpressure / relief valve

Code	Material - XX <small>SS316L FPM EPDM PVPF EPDM</small>	Material - XX Flanged / Threaded	Flow Rate [l/h]	Pressure [bar]	Fittings
BV XX 103010Y		F / T	300		DN10
BV XX 208010Y		F / T	800		DN20
BV XX 408010Y	21 24 41 44	F	800	0 - 10	ANSI 3/4"
BV XX 315010Y		F / T	1,500		DN25
BV XX 515010Y		F	1,500		ANSI 1"

Overpressure valve

Model	Max Flow Rate [l/h]	Setting Pressure [bar]	Code	Contact parts
		Min Max Std		
VS1-S	250	0 19 10	VS1S250019_A	SS316L/PTFE
		20 45 20	VS1S250045_A	
		46 150 50	VS1S250150_A	

Injection valve

Code	Material Body / Diaphragm	Max Pressure [bar]	Nitrogen Volume [l]	Max Precharge [bar]	Fittings
HSTX005_A	SS316L / NBR	150 / 210	0.05	150	3/8" BSP
HSTX01_A			0.12		1/2" BSP
HSTX035_A			0.35		
HSTX07_A			0.7	105 / 150	3/4" BSP
HSTX08_A			0.8		
HSTX15_A			1.5		1" BSP
HSTX23_A			2.3		

Calibration pot

Code SS316L	Code PVDF	Volume [l]	Suggested flow rate [l/h] for minimum 30" calibration
CP0004B36AA1B	CP0004B96AA1B	0.04	0 - 4.6
CP0050B36CA1B	CP0050B96CA1B	0.5	4.6 - 57
CP0100B36CA0B	CP0100B96CA0B	1	57 - 114
CP0150B36CA0B	CP0150B96CA0B	1.5	114 - 171
CP0300B36EA0B	CP0300B96EA0B	3	228 - 342
CP0500B36EA0B	CP0500B96EA0B	5	342 - 570
CP1000B36FA0B	CP1000B96FA0B	10	570 - 1,140
CP2000B36FA0B	CP2000B96FA0B	20	1,710 - 2,280
CP2500B36FA0B	CP2500B96FA0B	25	2,280 - 2,850

Model	Max Flow Rate [l/h]	Setting Pressure [bar]	Code	Contact parts
VSM-P (PVC)	300	0 - 5	VSM1P03005_A	PVC/PTFE
	800		VSM2P08005_A	
	1,500		VSM3P15005_A	

Injection valve

Model	Max Flow Rate [l/h]	Setting Pressure [bar]	Code	Contact parts
VZX-S (SS316L)	80	2	VZX1S00502_A	SS316L
	100		VZX3S01002_A	
	200		VZX4S02002_A	
	420		VZX5S04202_A	
	800		VZX6S08002_A	
	1,650		VZX7S16502_A	

Model	Max Flow Rate [l/h]	Setting Pressure [bar]	Code	Contact parts
		Min Max Std		
VS2-S	650	0 13 10	VS2S2650013_A	SS316L/PTFE
		14 30 20	VS2S2650030_A	
		31 150 50	VS2S650100_A	

Code	Material Body / Diaphragm	Max Pressure [bar]	Nitrogen Volume [l]	Max Precharge [bar]	Fittings
HSTPVC005_A	PVC / FPM	10	0.05		3/8" BSP
HSTPVC01_A			0.12		
HSTPVC035_A			0.35	7	1/2" BSP
HSTPVC07_A			0.7		
HSTPVC15_A			1.5		3/4" BSP
HSTPVC15_A			2.3		

Aktua series - linear electric control

Code	Description	For Spring pumps series
SAL025M00000	Electric Actuator Aktua Series	All
SA99106004	Installation Actuator Interface	MS1A064 / 094
SA99106005		MS1B108
SA99106001		MS1C138 / 165
SA99106002		PS1
SA99106003		PS2

Y-Strainer

Code SS316L	Code PVDF	Connection
FYP3240200_A	FYS3240008_A	3/8" BSP
FYP3230040_A	FYS3240100_A	1/2" BSP
FYP3230060_A	FYS3240110_A	3/4" BSP
FYP3230080_A	FYS3240120_A	1" BSP

Peristaltic Pump Accessories

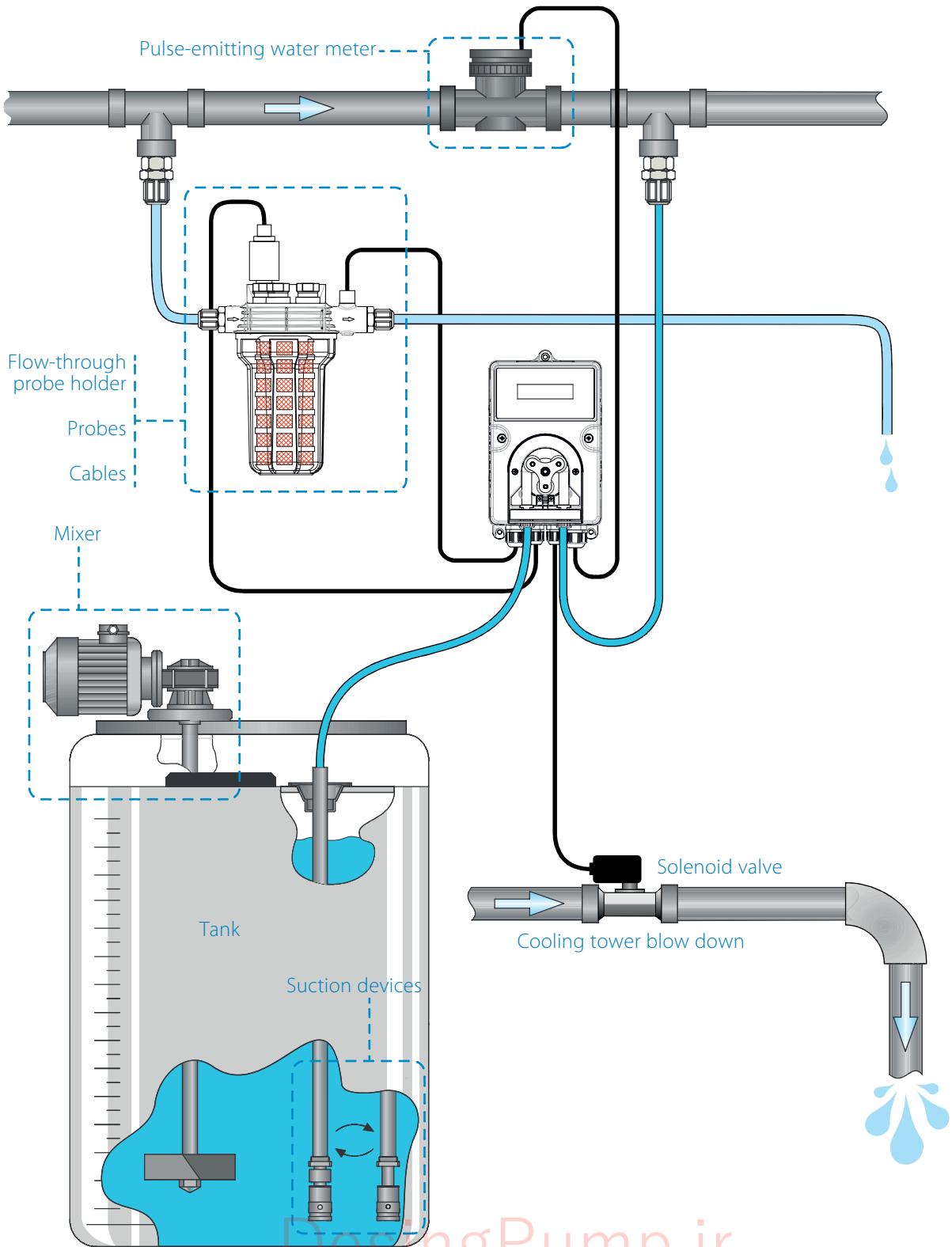

Peristaltic Pump Accessories

Flow-through probe holder						
Model	Temp [°C]	Pressure [bar]	Body	Flow sensor	Probes	Code
PSS7	40	6	Blue PP + transparent PMMA	Not included - Ø12	Not included	9900103021
PSS8-A		2	PP + transparent PMMA			Included - Ø12
PSS8-A1			PP + black PP	9900103088		
PSS8-A HP		5	PP + transparent PMMA	9900103090		
PSS8-A1 HP			PP + black PP	9900103091		

Probes									
Model	Measurement range	Temp range [°C]	Pressure [bar]	Body	Membrane	Junction	Cable length [m]	Connection	Code
SPH1-WP-S1-1.5	2 - 12 pH	0 - 60	6	PC	Glass	Single	1.5	BNC	9900105001
SPH1-WP-S1-6	2 - 12 pH	0 - 60	6	PC	Glass	Single	6	BNC	9900105096
SPH1-WP-S1-DJ	2 - 12 pH	0 - 60	6	PC	Glass	Double	1.5	BNC	9900105105
SPH2-WP	2 - 12 pH	0 - 60	6	Epoxy	Glass	Single	-	PG 13.5 mm - S8	9900105003
SPH3-WW	0 - 14 pH	0 - 80	6	Glass	Glass	Double	-	PG 13.5 mm - S8	9900105005
SPH4-HP	0 - 14 pH	0 - 60	6	Glass	Glass	Double	-	PG 13.5 mm - S8	9900105006
SPH4-HT	0 - 14 pH	0 - 130	16 @ 25°C	Glass	Glass	Double	-	PG 13.5 mm - S8	9900105007
SPH4-LC	0 - 14 pH	10 - 40	0.5	Glass	Glass	Double	-	PG 13.5 mm - S7	9900105008
SPH4-CR	0 - 14 pH	0 - 60	2	Glass	Glass	Double	-	PG 13.5 mm - S8	9900105016
SPH4-HF	0 - 14 pH	10 - 100	16 @ 100°C	Glass	Glass	Double	1.5	PG 13.5 mm - S8	9900105017
SRH1-WP-SJ-1.5	±1,000 mV	0 - 60	6	PC	-	Single	1.5	BNC	9900105031
SRH1-WP-SJ-6	±1,000 mV	0 - 60	6	PC	-	Single	6	BNC	9900105097
SRH1-WP-DJ	±1,000 mV	0 - 60	6	PC	-	Double	6	BNC	9900105104
SRH1-WP-AU	±2,000 mV	0 - 60	6	PC	-	Single	6	BNC	9900105103
SRH2-WP	±1,000 mV	0 - 60	6	Epoxy	-	Single	6	BNC	9900105083
SRH3-WW	±1,000 mV	0 - 80	6	Glass	-	Double	-	PG 13.5 mm - S8	9900105033
SRH4-HT	±2,000 mV	0 - 130	16 @ 130°C	Glass	-	Double	-	PG 13.5 mm - S8	9900105034
Pt100 3 wire 12mm	0±100°C	-	0±7	-	-	-	5 (3-wire)	12 mm	9900105061
Pt100 3 wire PG 13.5	0±100°C	-	0±7	-	-	-	5 (3-wire)	PG 13.5 mm	9900105062

pH/ORP probes cable					
Model	Connection	Connected	Cable [Ø 5mm]	Cable length [m]	Code
CE-1	S7 and BNC	No	COAX RG58	1	9900108001
CE-5		No	COAX RG58	5	9900108003
CE-10		No	COAX RG58	10	9900108004
CE-20		No	COAX RG58	20	9900108006
CE-10-HT		No	Low Noise COAX	10	9900110001
CE-20-HT		No	Low Noise COAX	20	9900110002
CE-1-B		Yes	COAX RG58	1	9900109001
CE-5-B		Yes	COAX RG58	5	9900109003
CE-10-B		Yes	COAX RG58	10	9900109004
CE-20-B		Yes	COAX RG58	20	9900109006
CE-10-HT-B		Yes	Low Noise COAX	10	9900110101
CE-20-HT-B		Yes	Low Noise COAX	20	9900110102

Duotek AODD Accessories

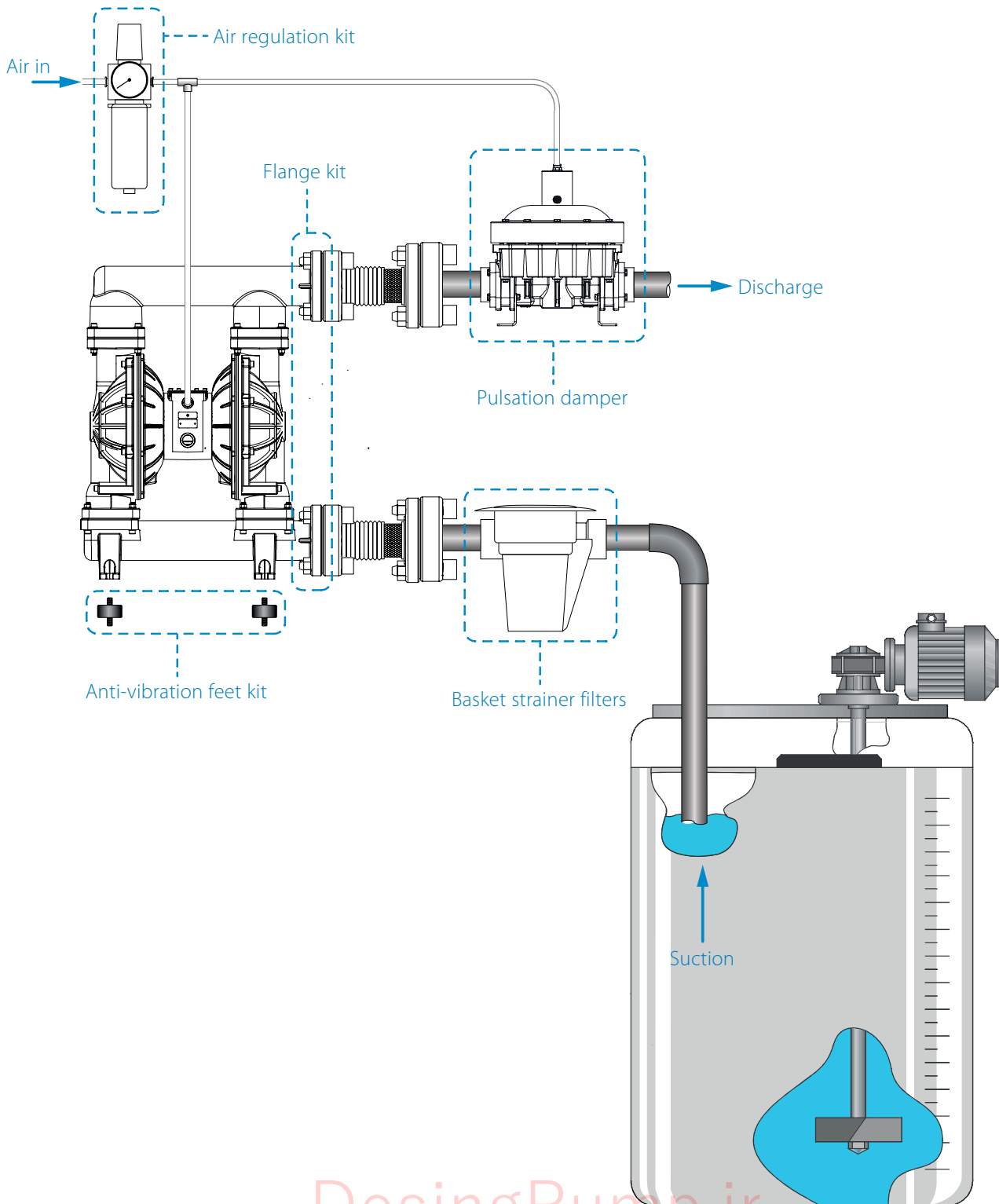

Duotek AODD Accessories

Air regulation kit

Model	Connection	For use with pumps	Code
AFAK	1/4"	from 0007 to 0030	AFAK0030
		0055 - 0060	AFAK0060
	3/8"	from 0090 to 0120	AFAK0120
	1/2"	from 0170 to 0400	AFAK0400
	1"	from 0700 to 1000	AFAK1000

Flanges kit

Model	Size	For use with pumps	Code
AFFK	1/2" - DN16	from 0030 to 0060	AFFK0060
	3/4" - DN20	0090 - 0100	AFFK0100
	1" - DN25	0120 - 0170	AFFK0170
	1 1/4" - DN32	0252	AFFK0252
	1 1/2" - DN40	0400	AFFK0400
	2" - DN50	0700	AFFK0700
	3" - DN80	1000	AFFK1000

Pneumatic batch counter

add AFPV__

Model	Note	For use with pumps	Code
AFSS	See above	from 0700 to 1000	AFSS1000

Electronic batch counter

add AFSC1000 + AFSV1000

Model	Note	For use with pumps	Code
AFFC	See above	from 0700 to 1000	AFFC1000

Stroke counter

add AFSV__

Model	Note	For use with pumps	Code
AFSC	See above	from 0700 to 1000	AFSC1000

Air regulation kit

Model	Connection	Code (threaded)	Code (flanged)
AFBS	1"	AFBS0160	AFBS0160F
	1 1/2"	AFBS0400	AFBS0400F
	2"	AFBS0700	AFBS0700F
	3"	AFBS1000	AFBS1000F

Solenoid valve - single way 3/2

Model	Connection	For use with pumps	Code
AFSV	1/8"	from 0007 to 0030	AFSV0030
	1/4"	from 0050 to 0120	AFSV0120
	3/8"	0170 - 0252	AFSV0252
	1/2"	0400 - 0700	AFSV0700

Reinforced hose

Model	Size [mm]	For use with pumps	Code
AFSV	20	from 0030 to 0060	AFRH0060
	25	0100 - 0120	AFRH0120
	30	0170	AFRH0170
	35	0252	AFRH0252
	40	0400	AFRH0400
	50	0700	AFRH0700

Ball valve

Model	Connection	For use with pumps	Code
AFBV	1/8"	from 0007 to 0030	AFBV0030
	1/4"	0055 - 0060	AFBV0060
	3/8"	from 0090 to 0120	AFBV0120
	1/2"	from 0170 to 0400	AFBV0400
	3/4"	from 0700 to 1000	AFBV1000

Anti-vibration feet kit

Model	Thread	For use with pumps	Code
AFVK	M4	0007	AFVK0007
		0018	AFVK0018
		0030	AFVK0030
	M5	from 0050 to 0060	AFVK0060
		from 0090 to 0120	AFVK0120
		0170 - 0252	AFVK0252
	M6	0400	AFVK0400
		0700	AFVK0700
	M10	1000	AFVK1000

Diaphragm leakage detector

Central Block modification included

Model	Note	For use with pumps	Code
AFFG	See above	from 0700 to 1000	AFFG1000

Diaphragm leakage detector sensor

Central Block modification included

Model	Note	for use with pumps	Code
AFSG	See above	from 0700 to 1000	AFSG1000

Accurate system

add AFSA__

Model	Note	For use with pumps	Code
AFGC	See above	from 0700 to 1000	AFGC1000

Pneumatic valve - single way 3/2

Model	Connection	For use with pumps	Code
AFPV	1/8"	from 0007 to 0030	AFPV0030
	1/4"	from 0050 to 0120	AFPV0120
	3/8"	0170 - 0252	AFPV0252
	1/2"	0400 - 0700	AFPV0700

Solenoid valve - for accurate - 3/2

Model	Connection	For use with pumps	Code
AFSA	1/8"	from 0007 to 0030	AFSA0030
	1/4"	0060	AFSA0050
	3/8"	from 0090 - 0120	AFSA0100
	1/2"	0170 - 0252	AFSA0250

Trolley

Model	Dimension	For use with pumps	Code
AFTT	330x240 mm	from 0007 to 0252	AFTT0252
	600x280 mm	0700	AFTT0700

Side Channel Blower Accessories

Compression

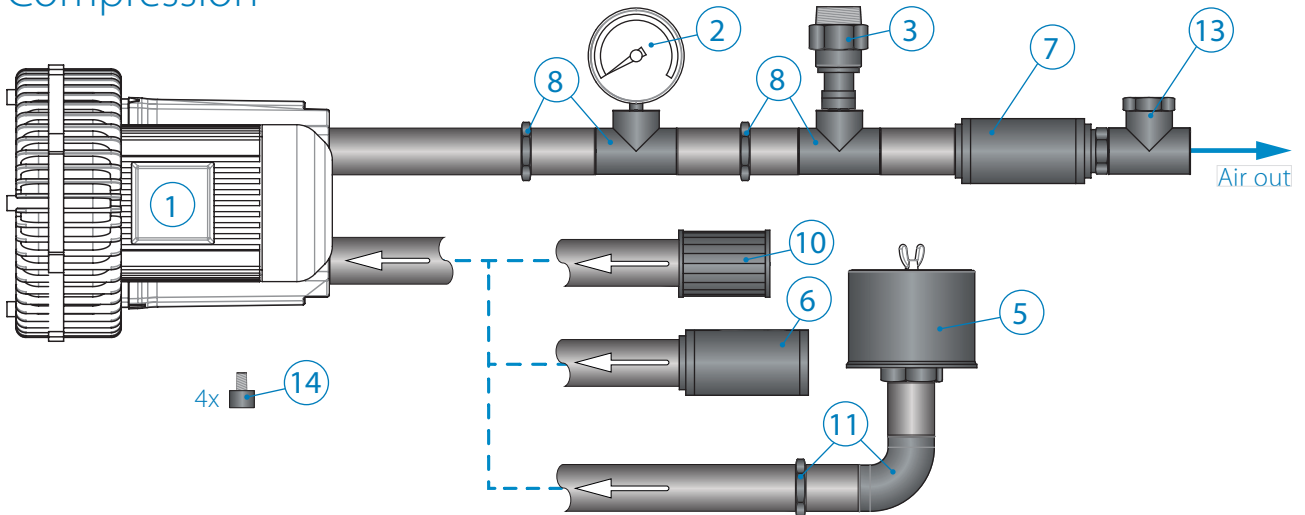

Exhaust

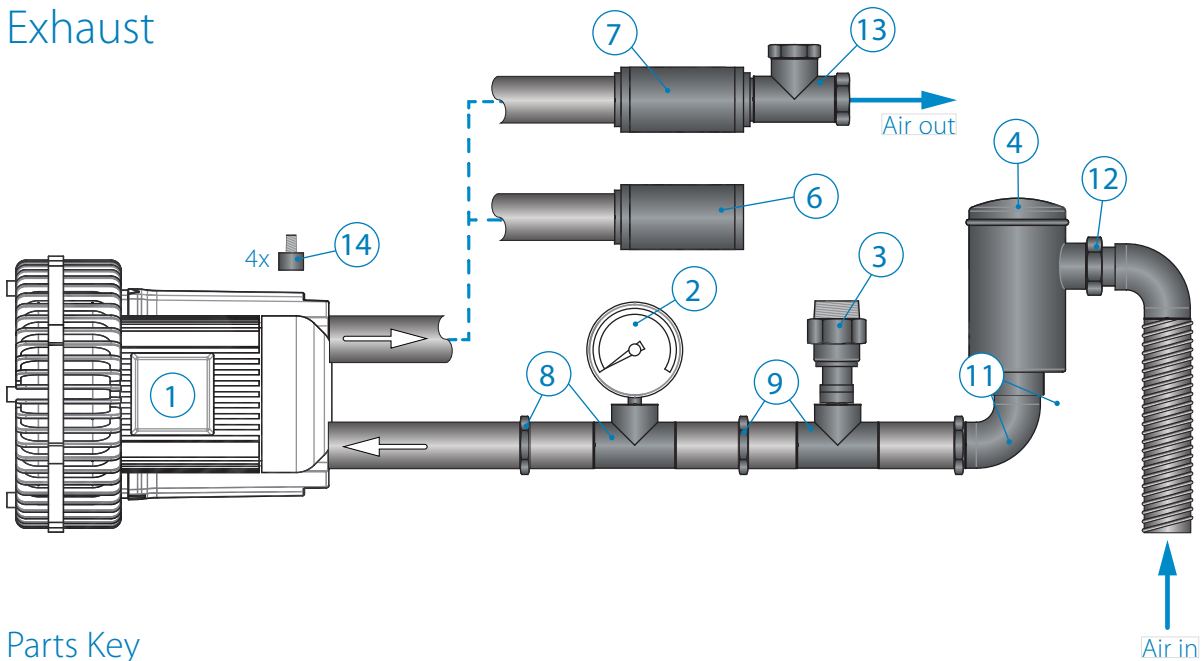

Parts Key

- 1 Side channel blower/exhauster
- 2 Vacuum/pressure gauge
- 3 Safety valve
- 4 In-line filter
- 5 Cartridge filter
- 6 Silencer
- 7 In-line silencer
- 8 Vacuum/pressure gauge kit
- 9 Connection valve kit
- 10 Metallic filter
- 11 Kit for cartridge filter
- 12 Kit sleeve + hose (1 mt)
- 13 Check valve
- 14 Anti-vibration pins

DosingPump.ir

Side Channel Blower Accessories

Safety valve				
Model	Size	Setting Pressure [bar]	Material	Code
BLSV	¼" M	0 - 300	Aluminum	BLSV032AL03
		300 - 600		BLSV032AL36
	2" F	100 - 300		BLSV050AL13
		300 - 600		BLSV050AL36
	4" F	100 - 200		BLSV100AL12
		200 - 400		BLSV100AL24
		400 - 600		BLSV100AL36

In-line filter				
Blower size	Size	Code	Material	Code
1"¼	Paper 5-7µm	BLIL032PA007	Polyester 25µm	BLIL032PO025
1"½		BLIL040PA007		BLIL040PO025
2"		BLIL050PA007		BLIL050PO025
2"½		BLIL065PA007		BLIL065PO025
3"		BLIL080PA007		BLIL080PO025
4" short		BLIL105PA007		BLIL105PO025
4"		BLIL100PA007		BLIL100PO025

In-line filter			Cartridge filter installation kit				
Blower size	Material	Code	Model (PVC)	Code	Model (PVC)	Code	
1"¼	Paper 5-7µm	BLCF032PA007	Nipple 90 mm	BLKC032PN	Socket 150 mm	BLKC032PS	
1"½		BLCF040PA007				BLKC040PN	BLKC040PS
2"		BLCF050PA007				BLKC050PN	BLKC050PS
2"½		BLCF065PA007				BLKC065PN	BLKC065PS
3"		BLCF080PA007				-	-
4"		BLCF100PA007				BLKC100PN	BLKC100PS

Diffuser				
Type	Size	Model	Material	Code
DISC diffuser	9"	DISC 9	EPDM	BLDD09EN
			Silicon	BLDD09SN
	12.5"	DISC 12	EPDM	BLDD12EN
			Silicon	BLDD12SN
Easy fitting	¾" BSP	Easy fitting	EPDM	BLAR
			EPDM	BLTD03EN
	300/350	TUBULAR 300	Silicon	BLTD03SN
			EPDM	BLTD05EN
	500/550	TUBULAR 500	Silicon	BLTD05SN
			EPDM	BLTD08EN
	800/850	TUBULAR 800	Silicon	BLTD08SN
			EPDM	BLTD10EN
	1000/1050	TUBULAR 1000	Silicon	BLTD10SN
			EPDM	BLND09EN
NAPOW diff.	9"	NAPOW 9	EPDM	BLND09EN

Filter valve		Long accessories holder kit		
Size	Code	Size	Model	Code
2" F	BLFV05F	2"	2" M - 2" F	BLAL05005F
3" F	BLFV08F	2"½	2"½ M - 2" F	BLAL06505F
4" F	BLFV10F	4"	4" M - 4" F	BLAL10010F

Safety valve installation kit				
Model	Blower Size	Model	Material	Code
BLKS	1"¼	1"¼ M	Carbon Steel	BLKS032032C
	1"½			BLKS032040C
	2"	2" F		BLKS032050C
				BLKS05F050C
	2"½	BLKS05F065C		
	3"	3" F		BLKS08F080C
	4"	4" F		BLKS10F100C
	5"			BLKS10F125C

Safety valve				
Blower size	Size	Code	Material	Code
1"¼	Stainless Steel 30µm	BLIL032SS030	Stainless Steel 60µm	BLIL032SS060
1"½		BLIL040SS030		BLIL040SS060
2"		BLIL050SS030		BLIL050SS060
2"½		BLIL065SS030		BLIL065SS060
3"		BLIL080SS030		BLIL080SS060
4" short		BLIL105SS030		BLIL105SS060
4"		BLIL100SS030		BLIL100SS060

Silencer				
Blower size	Model (Zinc Plated)	Code	Model (Zinc Plated)	Code
1"¼	Final Silencer (internal mesh)	BLFS032ZPR	In-Line Silencer	BLIS032
1"½		BLFS040ZPR		BLIS040
2"		BLFS050ZPR		BLIS050
2"½		BLFS065ZPR		BLIS065
3"		BLFS080ZPR		BLIS080
4"		BLFS100ZPR		BLIS100

Check valve (brass)		Kit sleeve + hose (1 m)	
Blower size	Code	Code	
1"¼	BLCV032BR	BLSH032	
1"½	BLCV040BR	BLSH040	
2"	BLCV050BR	BLSH050	
2"½	BLCV065BR	BLSH065	
4"	BLCV100BR	BLSH100	

Anti-vibration pins		Indoor filter		
Size	Code	Blower size	Material	Code
6 mm	BLAV06	1"¼	Zinc Plated 100 µm	BLIF032ZP100
8 mm	BLAV08	1"½		BLIF040ZP100
10 mm	BLAV10	2"		BLIF050ZP100
12 mm	BLAV12	2"½		BLIF065ZP100

Pressure/vacuum gauge			Reverse flow valve	
Size	Model	Code	Model	Code
Ø 63 mm	Pressure	BLMN06306	5w - 2p	BLRV52
	Vacuum	BLVG06306	5w - 3p	BLRV53

Your Choice, Our Commitment

People choose to do business with SEKO for one or more reasons, but ultimately it is their choice, and therefore they merit our commitment. "Our commitment" is total and not only to our customers, but also to each other and the Company's to its employees.

Vision

**TO BE YOUR PARTNER
OF CHOICE FOR DOSING
SOLUTIONS, GLOBALLY**

SEKO, is a passionate, dedicated Global Family of Professionals. We listen to each of our Partners and are committed to deliver the right solution in the Hygiene, Water Treatment and Industrial Process markets.

Values

**MUTUAL RESPECT, QUALITY
AND SPIRIT OF COLLABORATION**

MUTUAL RESPECT

Mutual Respect because doing business is about being able to generate trust between Customer and Supplier. We'll deliver against our commitments, on time and in a transparent fashion, so you know can plan for your own business needs.

QUALITY

Quality for SEKO is a 360° reality. It covers not only the design, development, production and delivery of our products and solutions but it runs through the core professionalism of our teams.

SPIRIT OF COLLABORATION

Spirit of Collaboration is fundamental to our success and SEKO prides itself on how we work as a worldwide team, blending multiple country teams and functions to bring solutions to a Customer request or market need from an idea to the real world in very short time, across our global presence and beyond.



Your Choice, Our Commitment

In the modern Globalised world, being a privately owned Company has significant benefits especially for our Customers, our Partners. For over 40 years, SEKO has developed a Global organisation able to take the longer view, manage the pressure of the now, and to plan for the long term, delivering true Partnership for our Customers, with transparency and mutual respect for each other.

Whether it's for our renowned flexibility, our attention to detail, the high-quality products, or just the way we do business, we understand that it's Your Choice to do business with us. It is Our Commitment to fulfill your needs wherever you, our Customers are.



For more information about our portfolio, worldwide locations, approvals, certifications, and local representatives, please visit www.seko.com



SEKO reserves the right to amend and change specifications without prior notice. All pictures shown are for illustration purpose only. Actual product may vary due to product enhancement. Published data may be subject to change.

© 2021 SEKO, Layout and origin: UK, 850001 WIPUAS EN V01

DosingPump.ir